

IONIQ 6

OWNER'S MANUAL

Operation

Maintenance

Specifications

All information in this Owner's Manual is current at the time of publication. However, HYUNDAI reserves the right to make changes at any time so that our policy of continual product improvement may be carried out.

This manual applies to all models of this vehicle and includes descriptions and explanations of optional as well as standard equipment.

As a result, you may find material in this manual that does not apply to your specific vehicle.

Please note that some models are equipped with Left-Hand Drive (LHD). The explanations and illustrations for some operations in LHD models are opposite of those written in this manual.

CAUTION: MODIFICATIONS TO YOUR HYUNDAI

Your HYUNDAI should not be modified in any way. Such modifications may adversely affect the performance, safety or durability of your HYUNDAI and may, in addition, violate conditions of the limited warranties covering the vehicle. Certain modifications may also be in violation of regulations established by the Department of Transportation and other government agencies in your country.

TWO-WAY RADIO OR CELLULAR TELEPHONE INSTALLATION

Your vehicle is equipped with electronic components. It is possible for an improperly installed/adjusted two-way radio or cellular telephone to adversely affect electronic systems. For this reason, we recommend that you carefully follow the radio manufacturer's instructions or consult your HYUNDAI dealer for precautionary measures or special instructions if you choose to install one of these devices.

WARNING! (IF EQUIPPED)

The vehicle is equipped with a device of the system Pan-European eCall or UAE eCALL which calls emergency services. Any self- or unauthorized interference in the system Pan-European eCall or UAE eCALL in vehicle systems and its components, installing of equipment which is not recommended by vehicle manufacturer and/or in authorized HYUNDAI dealer can cause incorrect operation (of the device of) the system Pan-European eCall or UAE eCALL making erroneous calls, causing failure of the device (in cars) in case of traffic accident or other accidents, when you need emergency care. This may be dangerous and threaten your life!

SAFETY AND VEHICLE DAMAGE WARNING

This manual includes information titled as DANGER, WARNING, CAUTION and NOTICE. These titles indicate the following:

DANGER

DANGER indicates a hazardous situation which, if not avoided, will result in death or serious injury.

WARNING

WARNING indicates a hazardous situation which, if not avoided, could result in death or serious injury.

CAUTION

CAUTION indicates a hazardous situation which, if not avoided, could result in minor or moderate injury.

NOTICE

NOTICE indicates a situation which, if not avoided, could result in vehicle damage.

Table of contents

Information/Getting started with your electric vehicle	1
Vehicle information	2
Seats & Safety system	3
Instrument cluster	4
Convenience features	5
Driving your vehicle	6
Driver assistance system	7
Emergency situations	8
Maintenance	9
Index	I

1. Information/Getting started with your electric vehicle

Information	1-3
HYUNDAI Motor Company	1-3
How to use this manual.....	1-4
Safety messages.....	1-5
Vehicle modifications.....	1-6
Returning used vehicles (for Europe)	1-6
Vehicle data collection and event data recorders	1-7
About "Getting started with your electric vehicle"	1-8
Understanding your electric vehicle	1-9
Characteristics of your electric vehicle	1-9
Precautions when using the high voltage battery.....	1-11
Other precautions for electric vehicle management	1-12
Charging your electric vehicle.....	1-13
Safety precautions for charging your electric vehicle	1-13
Checking basic information on charging your electric vehicle	1-18
Using an AC charger	1-25
Using a DC charger	1-28
Using a portable charger (ICCB).....	1-33
Stopping charging immediately (For Europe)	1-40
Using EV mode functions.....	1-41
Checking the EV mode screen configuration	1-41
Checking energy information	1-43
Setting the next departure time.....	1-46
Setting scheduled charging and climate	1-48
Setting a battery discharging limit when using Vehicle to Load (V2L)	1-50
Setting electric vehicle specialized functions	1-51
Using V2L function	1-57
Safety precautions when using the V2L function.....	1-57
Using electricity outside the vehicle	1-60
Using electricity inside the vehicle	1-62
Solving V2L problems	1-63
Aux. Battery Saver+	1-65
Driving your electric vehicle	1-66
Starting and stopping the vehicle.....	1-66

1

Checking electric vehicle driving information	1-68
Countermeasures for accidents or fire.....	1-78
If the electric vehicle catches fire	1-78
If the electric vehicle is submerged	1-79
If the electric vehicle needs towing	1-79
Other precautions for electric vehicle accidents.....	1-80

Information

Congratulations, and thank you for choosing HYUNDAI. We are pleased to welcome you to the growing number of discerning people who drive HYUNDAs. We are very proud of the advanced engineering and high-quality construction of each HYUNDAI we build.

Your Owner's Manual will introduce you to the features and operation of your new HYUNDAI. To become familiar with your new HYUNDAI, so that you can fully enjoy it, read this Owner's Manual carefully before driving your new vehicle.

This manual contains important safety information and instructions intended to familiarize you with your vehicle's controls and safety features so you can safely operate your vehicle.

This manual also contains information on maintenance designed to enhance safe operation of the vehicle. It is recommended that all service and maintenance on your car be performed by an authorized HYUNDAI dealer. HYUNDAI dealers are prepared to provide high-quality service, maintenance and any other assistance that may be required.

This Owner's Manual should be considered a permanent part of your vehicle, and should be kept in the vehicle so you can refer to it at any time. The manual should stay with the vehicle if you sell it to provide the next owner with important operating, safety and maintenance information.

HYUNDAI MOTOR COMPANY

CAUTION

Severe vehicle damage may result from the use of poor quality lubricants that do not meet HYUNDAI specifications. You must always use high quality lubricants that meet the specifications listed in the Electric vehicle specifications section of the Owner's Manual.

Copyright 2024 HYUNDAI Motor Company. All rights reserved. No part of this publication may be reproduced, stored in any retrieval system or transmitted in any form or by any means without the prior written permission of HYUNDAI Motor Company.

HOW TO USE THIS MANUAL

We want to help you get the greatest possible driving pleasure from your vehicle. Your Owner's Manual can assist you in many ways. We strongly recommend that you read the entire manual. In order to minimize the chance of death or injury, you must read the WARNING and CAUTION sections in the manual.

Illustrations complement the words in this manual to best explain how to enjoy your vehicle. By reading your manual, you will learn about features, important safety information, and driving tips under various road conditions.

The general layout of the manual is provided in the Table of Contents. Use the index when looking for a specific area or subject; it has an alphabetical listing of all information in your manual.

Sections: This manual has nine chapters plus an index. Each section begins with a brief list of contents so you can tell at a glance if that section has the information you want.

SAFETY MESSAGES

Your safety, and the safety of others, is very important. This Owner's Manual provides you with many safety precautions and operating procedures. This information alerts you to potential hazards that may hurt you or others, as well as damage to your vehicle.

Safety messages found on vehicle labels and in this manual describe these hazards and what to do to avoid or reduce the risks.

Warnings and instructions contained in this manual are for your safety. Failure to follow safety warnings and instructions can lead to serious injury or death.

Throughout this manual DANGER, WARNING, CAUTION, NOTICE and the SAFETY ALERT SYMBOL will be used.



This is the safety alert symbol. It is used to alert you to potential physical injury hazards. Obey all safety messages that follow this symbol to avoid possible injury or death. The safety alert symbol precedes the signal words DANGER, WARNING and CAUTION.

DANGER

DANGER indicates a hazardous situation which, if not avoided, will result in death or serious injury.

WARNING

WARNING indicates a hazardous situation which, if not avoided, could result in death or serious injury.

CAUTION

CAUTION indicates a hazardous situation which, if not avoided, could result in minor or moderate injury.

NOTICE

NOTICE indicates a situation which, if not avoided, could result in vehicle damage.

VEHICLE MODIFICATIONS

- This vehicle should not be modified. Modification of your vehicle could affect its performance, safety or durability and may even violate governmental safety and emissions regulations.

In addition, damage or performance problems resulting from any modification may not be covered under warranty.

- If you use unauthorized electronic devices, it may cause the vehicle to operate abnormally, wire damage, battery discharge and fire.

RETURNING USED VEHICLES (FOR EUROPE)

HYUNDAI promotes an environmentally sound treatment for end of life vehicles and offers to take back your HYUNDAI end of life vehicles in accordance with the European Union (EU) End of Life Vehicles Directive.

You can get detailed information from your national HYUNDAI homepage.

VEHICLE DATA COLLECTION AND EVENT DATA RECORDERS

This vehicle is equipped with an event data recorder (EDR). The main purpose of an EDR is to record, in certain crash or near crash-like situations, such as an air bag deployment or hitting a road obstacle, data that will assist in understanding how a vehicle's systems performed. The EDR is designed to record data related to vehicle dynamics and safety systems for a short period of time, typically 30 seconds or less. The EDR in this vehicle is designed to record such data as:

- How various systems in your vehicle were operating;
- Whether or not the driver and passenger safety belts were buckled/fastened;
- How far (if at all) the driver was depressing the accelerator and/or brake pedal; and,
- How fast the vehicle was traveling.

These data can help provide a better understanding of the circumstances in which crashes and injuries occur. NOTE: EDR data is recorded by your vehicle only if a nontrivial crash situation occurs; no data are recorded by the EDR under normal driving conditions and no personal data (for example, name, gender, age, and crash location) are recorded. However, other parties, such as law enforcement, could combine the EDR data with the type of personally identifying data routinely acquired during a crash investigation.

To read data recorded by an EDR, special equipment is required, and access to the vehicle or the EDR is needed. In addition to the vehicle manufacturer, other parties, such as law enforcement, that have the special equipment, can read the information if they have access to the vehicle or the EDR.

About "Getting started with your electric vehicle"

"Getting started with your electric vehicle" provides information about new technologies applied to the vehicle and explains how to use the main features. "Getting started with your electric vehicle" allows you to quickly and easily understand new vehicle features and how to operate them conveniently.

- Before driving, carefully read the manual provided with the vehicle and follow all safety information and precautions for every vehicle feature.
- "Getting started with your electric vehicle" covers all optional specifications. It may include descriptions for features that are not equipped in the vehicle.
- Images of the exterior and interior of the vehicle in "Getting started with your electric vehicle" may differ from the actual vehicle.

Understanding your electric vehicle

Electric vehicles are driven using a battery and an electric motor. Understand the characteristics of your electric vehicle and check the features that you must know before driving it.

Characteristics of your electric vehicle

The characteristics that differentiate electric vehicles from gasoline and diesel vehicles are as follows:

- Electric vehicles are eco-friendly because they do not use fossil fuels for driving. Additionally, unlike gasoline and diesel vehicles, noise and vibration are minimal, and the vehicle's lifespan is relatively long.
- When slowing down or driving downhill, regenerative braking is used. Regenerative braking charges the high voltage battery and minimizes energy loss.
- If the high voltage battery is running low, you can charge the vehicle using the AC charger, DC charger, or portable charging cables. For more information, see "Charging your electric vehicle".

i Information

Regenerative braking uses an electric motor when decelerating and braking, and it transforms kinetic energy to electrical energy in order to charge the high voltage battery.

Battery information

The batteries used in the electric vehicle are as follows:

- **High voltage battery (high-capacity):** Drives the motor and operates the air-conditioning. It can be charged via an AC charger, DC charger, or portable charger.
- **12 V battery:** Operates all lamps, wipers, and audio system. It is automatically charged while the **READY** (ready indicator) is displayed on the instrument cluster or the high voltage battery is charged.

Main components of your electric vehicle

The main components of your electric vehicle and their functions are as follows:

- **On-Board Charger (OBC):** Charges the high voltage battery by converting the power grid's AC power to DC power.
- **Inverter:** Converts power from direct current (DC) to alternating current (AC) and supplies power to the motor, and converts power from AC to DC and charge the high voltage battery during deceleration and braking.
- **Low Voltage DC-DC Converter (LDC):** Converts the high voltage battery's power source to a low voltage (12 V) power source and supply power to the electrical devices in the vehicle.
- **Vehicle Control Unit (VCU):** Controls the various controllers and sensors on the vehicle.
- **Motor:** Uses electricity accumulated in the high voltage battery to drive the vehicle (same role as an engine in gasoline and diesel vehicles).
- **Reduction gear:** Delivers the rotational force of the motor to the tires at appropriate speeds and torque.
- **High voltage battery (Lithium-ion battery):** Stores and supplies power necessary for the electric vehicle to operate. (The separately installed 12 V battery provides power to the vehicle when the vehicle is in **ACC** or **OFF**.)

WARNING

- Do not remove or disassemble any high voltage battery's connectors and wires. Doing so may lead to accidents, such as electric shock, and result in serious injury and significantly degrade the vehicle's performance and durability.
 - When the high voltage battery or its related components require inspection and maintenance, we recommend that you contact an authorized HYUNDAI dealer.
-

Precautions when using the high voltage battery

Precautions for high voltage battery when driving and storing the vehicle are as follows:

CAUTION

- Keep the gauge of the high voltage battery from going below than 10 %. Storing the vehicle while the battery level is low for a long time may damage the battery or reduce the battery's capacity, potentially causing the need for a battery replacement.
- If a collision occurs and the vehicle is impacted, we recommend that you have the vehicle inspected by an authorized HYUNDAI dealer to check the battery connection status.
- Using the V2L function may reduce the driving distance due to the use of the high voltage battery energy, and repeated use of the V2L function may cause a decrease in the life of the high voltage battery
- Repeated use of a DC charger may cause a decrease in the life of the high voltage battery.
- The high voltage battery level may reduce naturally even if the vehicle is not driven.
- Storing the vehicle in temperatures that are too hot or cold may degrade the battery performance.
- The distance to empty or power output may vary depending on the driving conditions, such as the outside temperature. Driving at high speeds or uphill will increase battery consumption, resulting in a shorter distance to empty.
- If you use the air conditioning or heating, which is powered by the high voltage battery, the distance to empty will decrease. Maintain proper temperature when using the air conditioning or heating.
- Depending on the vehicle's period of use, natural degradation of the battery may occur, so the distance to empty may decrease. When the charge capacity and distance to empty keep failing, we recommend that you have the vehicle inspected by an authorized HYUNDAI dealer.
- If you do not use the vehicle for a long time, charge the vehicle at least once every three months to prevent the battery from fully discharging. When the battery level has lower power, immediately charge the vehicle.
- To keep the battery in optimal condition, use AC charging. Fully charging the battery when it is 20 % or lower helps to keep the battery in optimal condition. (Charging once a month or more is recommended.)
- The charging level value displayed on the instrument cluster may decrease according to the charging conditions (charger status, outside temperature, battery temperature, etc.). For longer battery life and safety, after a certain charging level is reached, the charging current is gradually lowered to fully charge the battery.

Other precautions for electric vehicle management

CAUTION

- If post repair heat treatment after repairs or painting is required after an accident, the high voltage battery's performance may be degraded. If heat treatment is required, we recommend that you contact an authorized HYUNDAI dealer.
 - When cleaning the motor compartment, do not use a high-pressure washer. Doing so may result in electric shock, due to a discharge in high voltage electricity, or damage the vehicle's electric system.
 - Do not install third-party parts or modified parts on the vehicle. Doing so may damage the electric power system. Only use or install genuine parts.
-

High voltage cut-off switch

High voltage cut-off switch is a device located inside the motor compartment to block the battery's high voltage when your vehicle is inspected at an authorized HYUNDAI dealer.

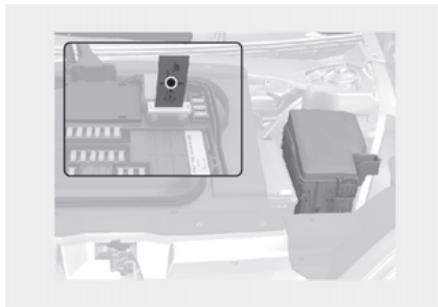

WARNING

- Never touch the high voltage cut-off switch. This could result in serious injury or death in a collision or electric shock.
 - If the high voltage cut-off switch requires an inspection or repair, we recommend that you contact an authorized HYUNDAI dealer.
 - Never disconnect or cut the high voltage cut-off switch except in an emergency situation. Serious problems may occur, such as the vehicle may not start.
-

Charging your electric vehicle

Check the detailed information about charging an electric vehicle and charge your vehicle.

Electric vehicles can be charged via an AC charger or DC charger installed at public charging stations. If the vehicle cannot be moved to a public charging station in the event of an emergency, you can charge the vehicle via the In-Cable Control Box (ICCB) with a power source (AC 220 V).

To find a nearby charging station, refer to the "Searching for nearby charging stations" section in this chapter.

Safety precautions for charging your electric vehicle

Before charging your electric vehicle, carefully read and follow all the safety information below. Failure to do so may cause electric shock or fire and result in a serious injury, death, malfunctions, or property damage.

Precautions for electric medical devices

WARNING

Electromagnetic waves that are generated from the charger can seriously impact electric medical devices, such as an implantable cardiac pacemaker. When using such devices, make sure to consult with your doctor and the manufacturer to find out whether charging your electric vehicle will impact the operation of your device.

Basic safety precautions for charging



WARNING

- Before charging, apply the Electronic Parking Brake (EPB) with the brake pedal pressed, shift to P (Park) and turn off the vehicle. Movement of the vehicle while charging may result in property damage, serious injury, or death.
 - Use specified electric vehicle charger only. Failure to do so may damage the charger, charging cable, or vehicle. Also, it may lead to safety hazards, such as fire, explosion, etc.
 - To avoid property damage, serious injury, or death from electric shock and fire, follow the instructions below:
 - Do not touch the charging connector, charging plug, or the charging inlet when connecting the cable to the charger and the charging inlet on the vehicle.
 - Do not touch the charging connector and charging plug with wet hands, or when standing in water or snow while connecting the charging cable.
 - When connecting or removing the charging cable, you must hold the charging connector handle and charging plug.
 - Use a waterproof charger. Do not charge the vehicle in a place where rainwater may come into contact with the joints of the charging cable connector and the charging plug.
 - Ensure there is no water, dust, or other contaminants on the charging cable connector and the charging plug.
 - Immediately stop charging if you feel abnormal conditions, such as odor or smoke.
 - Do not charge the vehicle if there is a risk of lightning.
-

i Information

- While charging, the gear cannot be shifted from P (Park) to any other gear.
- Ensure the vehicle door is unlocked before disconnecting the charging connector. The unlock button on the charging connector does not work when the vehicle door is locked.
- To control the temperature of the high voltage battery while charging or when the battery temperature is high, the air conditioner is used to cool down the battery. It may generate noise or vibration from operation of the air conditioner compressor and cooling fan, but this is a normal condition when charging the high voltage battery.
- The cooling system may be operated when using the air conditioner during charging. This may degrade the air conditioner's performance temporarily.
- Depending on the condition and durability of the high voltage battery, charger specifications and condition, and ambient temperature, the time required for charging the battery and distance to empty may vary.
- In rare cases, you might hear high-frequency noise (a small beeping sound) outside the car when charging with a 400 V DC charger that has deteriorated or has long communication delay. The high-frequency noise can be generated only when the vehicle tries to reduce its own electromagnetic waves to keep DC charging as stable as possible. Do not worry about this beep noise, because it is intentional and does not affect the charging performance or the vehicle itself.

Precautions for operating the cooling fan

WARNING



Do not put your hand near the cooling fan in the motor compartment while charging. It may operate automatically to control the battery temperature, even if the vehicle is turned off.

Precautions for operating the charging door

Before operating the charging door, carefully read and follow all the safety information below.

CAUTION

- Before opening the charging door, check the direction in which the door opens and ensure that there is no interference with nearby objects when opening or closing the door.
 - When opening and closing the charging door, be careful not to bump your face, head, etc., or get your hands or other body parts caught in the door.
 - If you cannot open the charging door due to freezing weather, lightly tap or remove any ice near the charging door.
 - Do not try to forcibly open the charging door. It may cause damage to the charging door or cause a malfunction.
 - Do not hold the parts that support the charging door. Damage to parts or deformation of parts may cause vehicle damage and accidents.
-

Precautions for using, handling, and storing the charging cable

Precautions when using the charging cable

CAUTION

- To prevent electric shock, replace the charging cable if the coating or the connector is damaged.
 - Do not modify or disassemble the charging cable. Doing so may result in fire, electric shock, or injury.
 - Do not pull or twist the charging cable excessively, and ensure that the cable is not twisted. Power cuts or damage to the cable's insulation sheath may result in electric shock or fire.
 - Do not drag the charging cable on the floor or place objects on it. Damage to the insulation of the cable may result in electric shock or fire.
 - Do not use the charging cable near a heat source or heating appliance.
 - Do not drop or subject the charging cable to a strong impact. Also, ensure no water or liquid comes into contact with the cable.
 - Use the charging cable only when there are no children around.
 - If there is any sign of damage, corrosion, or rust on the charging connector and plug, or if the connection of the charging connector and plug feels loose, do not use the cable. We recommend that you have the vehicle inspected by an authorized HYUNDAI dealer.
-

Precautions when handling and storing the charging cable

CAUTION

- Always keep the charging connector and plug dry and clean.
 - Ensure that the connectors, plugs, and control box (portable charger) of the charging cable are not submerged or in contact with water.
 - Keep the charging cable free from water or moisture, and keep it in the cargo storage compartment.
 - Do not keep the charging cable near heat source or heating appliances.
 - Keep the charging cable away from children.
 - If there is dust or contaminants inside the charging connector or plug, remove it using the air gun.
 - If the charging cable is contaminated, completely disconnect the cable from the charger or power, and remove the contaminants.
 - Wipe the charging cable lightly with the soft cloth soaked with a 3 % neutral detergent aqueous solution, then use a clean cloth to completely remove moisture and dry the cable in a well-ventilated shade.
 - When removing contaminants, ensure the charging connector and charging plug are not in contact with water.
 - Do not use organic solvents, such as benzene, paint thinner, or detergent. Doing so may cause deformation, discoloration, or malfunction of charging cable.
 - When using a vehicle decontamination agent, ensure that the product does not contain organic solvents, such as benzene, paint thinner, or detergent.
-

Checking basic information on charging your electric vehicle

Before charging your vehicle, check and understand the information such as the expected charging time according to the charge type, checking the State of Charge (SOC), and setting the charger lock mode.

Checking charge types and times

The charge types for electric vehicle are as follows:

- **AC charge:** The electric vehicle is charged via an AC charger at public charging stations. An AC charger may require an AC charging cable (sold separately).
- **DC charge:** You can charge at high speeds at public charging stations. Refer to the respective company's manual that is provided for each DC charger type.
- **Portable charge:** If the vehicle cannot be moved to a public charging station due to a lack of battery power, the vehicle can be charged with household electricity, using the 220 V portable charger (sold separately).

CAUTION

- Battery performance and life may deteriorate if the DC charger is used constantly. Use of DC charging should be minimized in order to help prolong high voltage battery life. Use AC charging unless DC charging is necessary.
 - The electrical outlet at home must comply with regulations and can safely accommodate the voltage, current (amps), and power (watts) ratings specified on the portable charger. If not, the vehicle may not be charged or safety hazards, such as fire, may occur.
 - If the power distributor exceeds its capacity while charging the vehicle with a portable charger at home, the power to home may be cut off or a fire may occur.
 - If you use a portable charger to charge your electric vehicle with household electricity, you will be charged on your household electricity bill.
-

The estimated charging time for each charging type is as follows:

Charging type		Charging time		Charge level (Minimum - Maximum)	Charging condition (Temperature)
		Standard battery type	Extended battery type		
AC charge		About 5 hours 25 minutes	About 7 hours 20 minutes	10-100 %	Room temperature (25 °C)
DC charge	350 kW	About 18 minutes	About 18 minutes	10-80 %	
	50 kW	About 58 minutes	About 73 minutes	10-80 %	
Portable charge		About 22 hours 35 minutes	About 32 hours 45 minutes	10-100 %	

i Information

- Depending on the condition and duration of use of the high voltage battery, charger specifications, and ambient temperature, the time required for charging the high voltage battery may vary.
- If the charger is worn out, exposed, or there exists any type of damage, charging may stop for your safety. Use another charger that works normally.
- When charging the battery, an additional 3 minutes may be required to check battery condition.

Checking the charging status

Check the State of Charge (SOC) of the high voltage battery via the charge indicator lamp inside the charging door.





1. With the vehicle door unlocked, press the open indicator on the charging door to open the charging door.
2. Check the SOC referring to the charge indicator lamp inside the charging door.
 - SOC is indicated in 4 levels.

Type A



Type B



Charge indicator lamp	SOC [%]
	0-24 %
	25-49 %
	50-74 %
	75-100 %

Checking information on the charging label

Open the charging door and check the information on the charging label on the right side of the charging connector. The charging label shows safety symbols and the rated input specifications for charging.

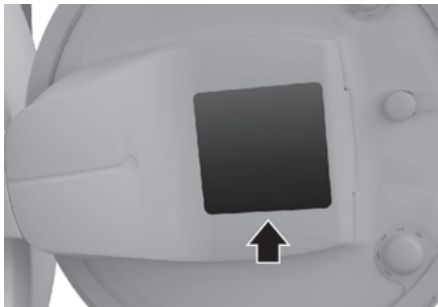

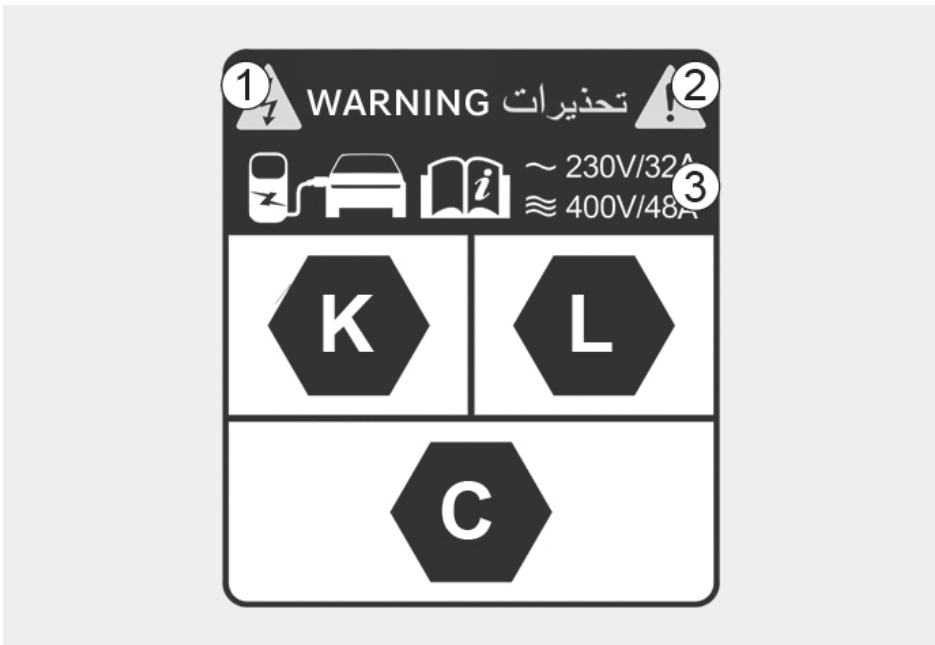

No.	Name	Description
(1)	Warning for high voltage	Indicates a device with a risk of electric shock.
(2)	Warning/Caution symbol	Indicates a device that may cause property damage, serious injury or death if not operated carefully.
(3)	Rated voltage and maximum charging current	Indicates the type of input current (~, AC) and the rated voltage range (V) and charging current (A) when AC charging.

When the electric charging door closes automatically

+ if equipped

The electric charging door closes automatically in the following situations. Check the operation conditions and reset the charging door if it does not open under normal use conditions.

- When the charging connector is disconnected.
- When the charging door is opened and charging has not started.
- When the gear is shifted to D (Drive), N (Neutral), or R (Reverse).

Resetting the electric charging door

If the electric charging door malfunctions or if the 12 V battery has been replaced, reset the charging door by turning the vehicle on and off once.

- If the charging door malfunctions continuously after resetting the charging door, we recommend that you have the vehicle inspected by an authorized HYUNDAI dealer.
- If you have replaced the charging door due to a malfunction, reconnect the wiring connector from the vehicle to the charging door module, and remove the broken wiring connectors.

Setting charging connector locking mode

You can lock the charging connector during AC charging to prevent unintended detachment of the charging connector from the vehicle.

***i* Information**

The connector is automatically locked during DC charging or while using the V2L function, regardless of the settings of charging connector locking mode applied to the vehicle.

- When DC charging is complete, the charging connector will be unlocked automatically.
 - After using electricity, you can unlock the charging connector by pressing the switch on the V2L connector to turn off the power and unlock the vehicle door.
-

On the infotainment system, select **EV** > **(EV Setting)** > **Charging Connector Locking Mode** to set the locking mode of the charging connector.

The available locking mode options are as follows:

- **Always:** Locks the connector automatically whenever the charging connector is plugged into the charging inlet.
- **While Charging:** Locks the connector automatically only while charging is in progress after the charging connector is properly connected to the vehicle.
- **Do Not Lock:** Unlocks the connector regardless of the charging state.

Disconnecting the charging connector in an emergency

If the unlock button is not functioning properly due to a discharged battery or abnormal electrical wiring, the charging connector cannot be disconnected from the vehicle.

CAUTION

Do not disconnect the charging connector forcibly. Doing so may damage the charging connector or the charging inlet on the vehicle.

If the charging door does not open due to battery being fully discharged or a wiring failure, open the trunk and pull the emergency cable on the trunk's right wall.



- If the unlock button still does not operate after pulling the emergency cable, we recommend that you have the vehicle inspected by an authorized HYUNDAI dealer.

Using an AC charger

AC charging is the most common charging method for electric vehicles. Charge your electric vehicle using an AC charging cable installed in public charging stations or separately purchased AC charging cable.

- To find a nearby charging station, refer to the "Searching for nearby charging stations" section in this chapter.

WARNING

Before charging the vehicle, carefully read and follow the instructions in "Safety precautions for charging your electric vehicle" to prevent property damage or injury due to electric shock, fire, explosion, etc.

CAUTION

To prevent property damage or injury due to fire or explosion, follow the instructions below.

- Only use the genuine AC charging cable provided by the manufacturer (if equipped).
- Do not use an extension cable.
- Check the rated voltage and maximum charging current required for charging, and ensure that the charger power you are using meets the requirements.
- Immediately stop charging if you discover abnormal conditions, such as odor or smoke.

Understanding the AC charging cable

The exterior and configuration of the AC charging cable are as follows:



- (1) Charging connector (Vehicle side)
- (2) Charging plug (Charger side)

Charging with an AC charger

Follow the instructions below to charge the vehicle with an AC charger.

1. With the vehicle started, apply the Electronic Parking Brake (EPB) while pressing the brake pedal.
2. Turn all switches off, shift to P (Park), and stop the vehicle.
3. With the vehicle door unlocked, press the open indicator on the charging door to open the charging door.
4. Open the charging inlet cover and check the charging connector and charging inlet for dust or other contaminants
 - If there is any dirt or contaminants, remove it using the air gun.

WARNING

Do not touch the charging connector of the charging cable or the charging inlet on the vehicle.

5. Remove the charging connector protection cap of the AC charging cable, hold the charging connector handle, and connect it to the AC charging inlet on the vehicle. Push it until you hear a click.
6. **[If using separately purchased charging cable]** Remove the charging plug protection cap of the AC charging cable, hold the charging plug handle, and connect it to the electric outlet (220 V) of the AC charger.
 - This process is required only when using a separately purchased AC charging cable. If you use a charging cable installed in an AC charger, a separate charging plug connection is not required.
 - When charging starts, the estimated charging time will be displayed on the instrument cluster for about one minute.

Information

- If you open the driver's door while charging, the estimated charging time will also be displayed on the instrument cluster for about one minute.
 - When scheduled charging is set, a message saying '**Waiting to charge at scheduled time**' will be displayed.
 - When scheduled air conditioner or heater operates while waiting for the scheduled charging, the estimated charging time will be displayed as "-".
-

7. **[If using a separately purchased charging cable]**When charging is complete, hold the charging plug handle, disconnect the charging plug from the electric outlet (220 V) of the AC charger, and close the protection cap of the charging plug.
 - This process is required only when using an AC charging cable purchased separately. If you use a charging cable installed in an AC charger, a separate charging plug disconnection is not required.
8. Hold the charging connector handle with the unlock button pressed, and pull the charging connector to disconnect it from the charging inlet.

CAUTION

Do not forcibly disconnect the charging connector without pressing the unlock button on the charging connector. It may damage the charging connector or the charging inlet on the vehicle.

9. Close the charging inlet cover and press the charging door to completely close it.

Information

- If the charging connector locking mode is set to **Always** or **While Charging**, unlock the door by pressing the button on the smart key or the button on the driver's door, and disconnect the charging connector from the charging inlet.
 - For more information, refer to the "Setting charging connector locking mode" section in this chapter.
 - During AC charging, the quality of radio reception may degrade in some areas.
-

Using a DC charger

If you need to charge the vehicle in a short time, you can charge at high speeds using a DC charger installed in public charging stations.

- To find a nearby charging station, refer to the "Searching for nearby charging stations" section in this chapter.

WARNING

Before charging the vehicle, carefully read and follow the instructions in "Setting charging connector locking mode" to prevent property damage or injury due to electric shock, fire, explosion, etc.

CAUTION

Battery performance and life may deteriorate if the DC charger is used constantly. Use of DC charging should be minimized in order to help prolong high voltage battery life. Use AC charging unless DC charging is necessary.

Understanding the DC charging connector

The exterior of the DC charging cable is as follows:

Type A



Type B



(1) DC charging connector (Vehicle side)

Charging with a DC charger

Follow the instructions below to charge the vehicle with a DC charger.

1. With the vehicle started, apply the Electronic Parking Brake (EPB) while pressing the brake pedal.
2. Turn all switches off, shift to P (Park), and stop the vehicle.
3. With the vehicle door unlocked, press the open indicator on the charging door to open the charging door.
4. Open the charging inlet cover and check the charging connector and charging inlet for dust or other contaminants.
 - If there is any dirt or contaminants, remove it using the air gun.

WARNING

Do not touch the charging connector of the charging cable or the charging inlet on the vehicle.

5. Remove the charging connector protection cap of the DC charging cable, hold the charging connector handle, and connect it to the DC charging inlet on the vehicle. Push it until you hear a click.
 - When charging starts, the estimated charging time will be displayed on the instrument cluster for a minute.

Information

- If you open the driver's door while charging, the estimated charging time will also be displayed on the instrument cluster for a minute.
-

6. When charging is complete, hold the charging connector handle with the unlock button pressed and pull on the charging connector to disconnect it from the charging inlet.

- Depending on the DC charger types, some DC chargers may not have a charger connector unlock button.

 **CAUTION**

Before disconnecting the charging connector, check if there is an unlock button on the connector handle. If the connector handle is equipped with an unlock button, forcibly disconnecting the connector without pressing the button may damage the charging connector or charging inlet on the vehicle.

NOTICE

- For more information, refer to the "Setting charging connector locking mode" section in this chapter.
-

7. Close the charging inlet cover.

8. Press the charging door to completely close it.

Using Plug n charge (For Europe)

When charging with a DC charger, you can use the Plug n charge function to charge your electric vehicle quickly and easily.

Setting the Plug n charge

Follow the instructions below to charge your electric vehicle setting the Plug n charge.

1. On the infotainment system, select **EV Settings > Plug n charge** to turn on the function.

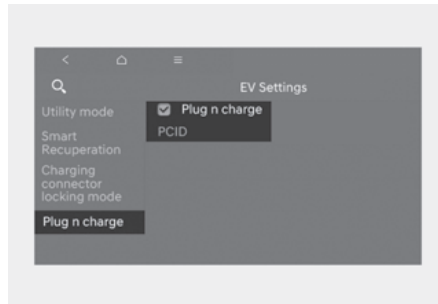

***i* Information**

If you do not have a Plug n charge contract, turn off the Plug n charge. If the function is turned on, problems with the charging process may occur.

Renewing the Plug n charge

If the Plug n charge does not proceed or fails during the process, check the expiration and renewal status of the contract certificate

- The Plug n charge does not proceed if the certificate has expired.
- Turn off the Plug n charge function and use an external payment method until you check the certificate status. If the Plug n charge fails more than 2 times, the payment method is forcibly switched to an external payment method from the third attempt.

***i* Information**

To reset and enable Plug n charge again after the payment method is forcibly switched to an external payment method, follow one of the instructions below:

- Charge once using an external payment method. Plug n charge is available from the next charge.
 - Disconnect the charging plug, close the charging door, and wait at least 1 minute with the vehicle on.
 - Use another charger that is Plug n charge enabled.
-

If the contract certificate for the Plug n charge has expired or withdrawn, follow the instructions below:

1. Make a new contract to issue or renew the certificate.
2. Connect the charging plug and try Plug n charge once.
 - The charger displays the expiration and withdrawal status of the certificate and the charging is failed.
3. Disconnect and reconnect the charging plug and retry charging.
 - The newly contracted certificate is installed and charging proceeds normally.

Managing the Plug n charge contract

If a new agreement certificate is installed, the **Manage Agreements** option becomes available. To see its details or manage it, follow the instructions below:

1. On the infotainment system, select **EV Settings > Plug n charge**, and then select **Manage Agreements**.
2. Check the contractor information and expiration date (year/month) displayed on the screen.
 - You can delete the certificate by pressing **Delete** if necessary.

Using a portable charger (ICCB)

If the vehicle cannot be moved to a public charging station, you can charge the vehicle using a separately purchased In-Cable Control Box (ICCB) in places where general power (AC 220 V) is supplied.

WARNING

Before charging the vehicle, carefully read and follow the instructions in "Setting charging connector locking mode" to prevent property damage or injury due to electric shock, fire, explosion, etc.

 **CAUTION**

To prevent property damage or injury due to fire or explosion, follow the instructions below.



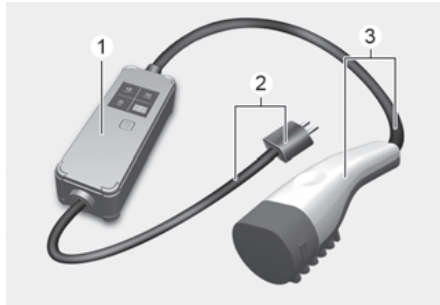

- Only use a genuine HYUNDAI portable charger (if equipped).
 - Do not let children operate or touch the portable charger. Doing so may lead to unexpected accidents.
 - Do not use an extension cable.
 - The charger power you are using must comply with regulations and safely accommodate the voltage, current (amps), and power (watts) ratings. If not, the vehicle may not be charged or safety hazards, such as fire, may occur.
 - If the power distributor exceeds its capacity while charging the vehicle with a portable charger at home, the power to the home may be cut off or a fire may occur.
 - Immediately stop charging if you discover abnormal conditions, such as odor or smoke.
 - Use a portable charger only in emergencies, and do not use it to fully charge the battery.
 - If you charge the vehicle with household electricity, you will be charged electricity bill according to the home rate system, not the electric vehicle rate system.
-

Understanding portable chargers

The configuration of a portable charger and the display of the operation indicator are as follows:



- (1) Control box
- (2) Power plug
- (3) Charging connector

Icon	Name	Color	Description
	POWER	Green	Turns on when the power is on.
	CHARGE	Blue	Turns on while charging and blinks when current is limited (Forcibly switched to 6 A).
	FAULT	Red	Blinks when a leakage current, communication error, or overcurrent error occurs, or when the high-temperature protection inside the plug and charger is activated.
	CHARGE LEVEL	-	Displays the present charging current setting (6 A, 8 A, 10 A, or 12 A).

Icon	Name	Color	Description	
	E1	Control pilot communication	-	Vehicle communication error
	E2	Leakage	-	Current leakage
	E3		-	Charger error
	E4	Plug temperature	-	Plug overtemperature warning
	E5		-	Plug temperature failure
	E6		-	Charger error
	E7	Overcurrent	-	Charging overcurrent warning
	E8	Internal temperature	-	Charger overheating
	E9		-	Charger error
	F1	Relay fusion	-	Charger error
	F2	Ground Monitoring/Interrupt	-	Poor grounding of outlet
	F3	Switched mode power supply power failure	-	Switched mode power supply error (voltage failure)
	F4		-	Switched mode power supply error (abnormal voltage)
	F5	Control Pilot voltage error	-	Control Pilot (-) voltage error
	F6		-	Control Pilot (+) voltage error
	F7	Temperature sensor error	-	Plug temperature sensor error
F8	-		PCB internal temperature sensor error	

- If an error occurs, you can reset the portable charger by disconnecting and reconnecting the power plug, and then pressing the button on the control box for more than two seconds.
- If the same symptom repeats after resetting the portable charger, we recommend that you have the vehicle inspected by an authorized HYUNDAI dealer.
- If there is no status change for more than one minute, the portable charger will be switched to power saving mode, and the display light will be turned off.

Charging with a portable charger

Follow the instructions below to charge the vehicle with a portable charger.

1. Connect the power plug of the portable charger to the electrical outlet at your home.
 - The power indicator light on the control box will turn green.
2. Set the charging current by pressing the button on the back of the control box for more than two seconds until the number on the charging current indicator blinks.

NOTICE

An example of a portable charger charging current setting suitable for the rated current of the power supplied is as follows. However, the appropriate charging current may vary depending on the environment, such as the power usage inside the building.

Outlet current	ICCB charge level
14-16 A	12 A
12-13 A	10 A
10-11 A	8 A
8-9 A	6 A

- The charging current is changed each time the button is pressed, in the order of "6 A - 8 A - 10 A - 12A."
- If 10 seconds have passed without pressing any button, the blinking will stop and the charging current will be finished.

3. With the vehicle started, apply the Electronic Parking Brake (EPB) while pressing the brake pedal.
4. Turn all switches off, shift to P (Park), and stop the vehicle.
5. With the vehicle door unlocked, press the open indicator on the charging door to open the charging door.
6. Open the charging inlet cover and check the charging connector and charging inlet for dust or other contaminants.
 - If there is any dirt or contaminants, remove it using the air gun.

WARNING

Do not touch the charging connector of the charging cable or the charging inlet of the vehicle.

7. Remove the charging connector protection cap of the portable charging cable, hold the charging connector handle, and connect it to the AC charging inlet of the vehicle. Push it until you hear a click.
 - When charging starts, the estimated charging time will be displayed on the instrument cluster for about one minute.

Information

- If you open the driver's door while charging, the estimated charging time will also be displayed on the instrument cluster for about one minute.
 - When scheduled charging is set, a message saying '**Waiting to charge at scheduled time**' will be displayed.
 - When scheduled air conditioner or heater operates while waiting for the scheduled charging, the estimated charging time will be displayed as '-'.
-

8. When charging is complete, hold the charging connector handle with the unlock button pressed and pull on the charging connector to disconnect it from the charging inlet.

i Information

If you have set the charging connector locking mode as **Always** or **While Charging**, unlock the door by pressing the button on the smart key or the button on the driver's door, and disconnect the charging connector from the charging inlet.

- For more information, refer to the "Setting charging connector locking mode" section in this chapter.

9. Close the charging inlet cover.
10. Press the charging door to completely close it.

Using the scheduled charging function

The scheduled charging function allows you to charge your vehicle using low-cost, late-night power until the next departure time.

i Information

You can use the scheduled charging function only when using an AC charger or the portable charger (ICCB: In-Cable Control Box). For more information about connecting an AC charger and portable charger, refer to the "Using an AC charger" and "Using a portable charger (ICCB)" section in this chapter.

On the All menus screen, select **EV > Scheduled Charging and Climate > Scheduled Charging**, set the date and time of when to charge the battery, and select an option.

- For more information, refer to the "Setting scheduled charging and climate" section in this chapter.
- When scheduled charging is set and the AC charger or the portable charger (ICCB) is connected for charging, the indicator lamp gradually illuminates for three minutes to indicate that scheduled charging is set.
- When scheduled charging is set, charging is not started immediately when the AC charger or portable charger (ICCB) is connected. To charge the vehicle immediately, select **EV > Scheduled Charging and Climate > Scheduled Charging** on the screen and deactivate the scheduled charge setting.

i Information

- You can set up or cancel scheduled charging using the HYUNDAI BlueLink app on your smartphone. For more information, refer to the infotainment system manual.
- Charging may start immediately after a charger is connected to the vehicle, depending on the charging time calculated when setting up the scheduled charging.

Stopping charging immediately (For Europe)

If you cannot stop charging the electric vehicle through the charger while charging with an AC charger, DC charger, or portable charger, follow the instructions below:

1. Press the door lock or unlock button of the vehicle.
2. Within 15 seconds after pressing the button, press the **HOLD** button for more than two seconds.

Checklist when charging does not start

Check the following if charging does not start after connecting the charger to the vehicle.

- Check the scheduled charging setting. If the scheduled charging is set, charging will not be started after connecting an AC charger or portable charger to the vehicle until the setting conditions are met.
- Check the operation status of the AC charger, DC charger, and portable charger. Actual method for indicating the operation status may vary in accordance with the charger manufacturer.
- If a warning sign related to charging appears on the instrument cluster, check its message.
- If the charging connector and charging inlet are not connected properly, the connector may droop or vibrate. In this case, hold the charging connector handle and push it all the way in.
- Check the charging status by connecting another charger that has been approved for proper operation.
 - If the vehicle is charged normally using another charger, contact the charger manufacturer for a solution.
 - If the vehicle is not charged even when using another charger, we recommend that you have the vehicle inspected by an authorized HYUNDAI dealer.

Using EV mode functions

EV mode provides driving information and high voltage battery information. You can set various electric vehicle functions in EV mode.

Checking the EV mode screen configuration

Follow the instruction below to enter EV mode and check the screen configuration.

1. On the infotainment system, swipe left on the Home screen to display the All menus screen.
2. On the All menus screen, select **EV**.
 - The EV mode screen appears.

The details of the EV mode screen is as follows:

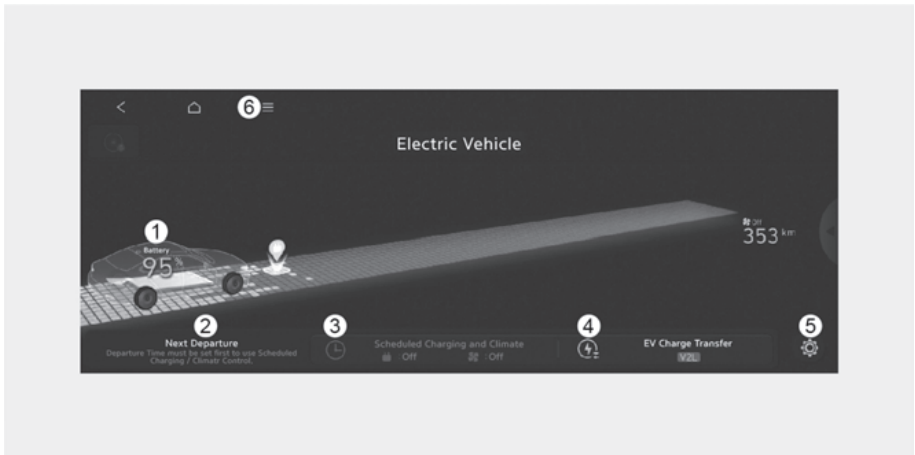

No.	Name	Description
(1)	Energy information	You can check the distance to empty, total battery power remaining, and expected charging time for each charge type.
(2)	Next departure time	You can set anticipated departure time for scheduled charging and target temperature.
(3)	Scheduled charging and climate control	You can set the date and time of when to charge the battery and the climate control temperature. Also, you may select the time to start charging using the off-peak time setting.
(4)	Vehicle to Load (V2L) setting	You can set the battery discharging limit (%) for the high voltage battery for driving.
(5)	EV setting	You can set various electric vehicle specialized functions. For more information, refer to the "Setting electric vehicle specialized functions" section in this chapter.
(6)	Menu	You can check energy information, charging station and EV settings.

Checking energy information

Check the distance to empty, State of Charge (SOC), and expected charging time and charge the vehicle if necessary.

- For more information about charging the vehicle, refer to the "Charging your electric vehicle" section in this chapter.
1. On the infotainment system, swipe left on the Home screen to display the All menus screen.
 2. On the All menus screen, select **EV** and select the vehicle image.
 3. On the Energy Information screen, select each item to check the vehicle energy information.

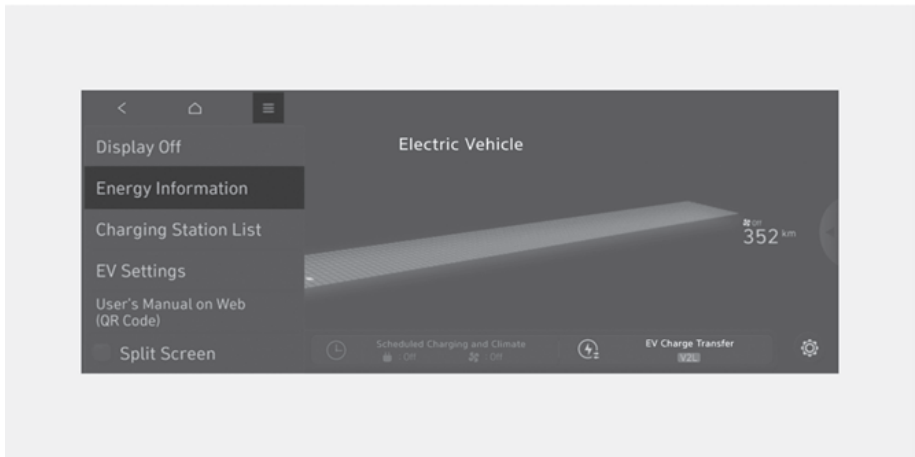

Checking the battery status

On the Energy Information screen, select **Battery Status**.

- You can check the current charge level, expected distance to empty, and charging time for each charge type.
- For more information about setting target battery charge level, refer to the "Setting the target battery charge level" section in this chapter.

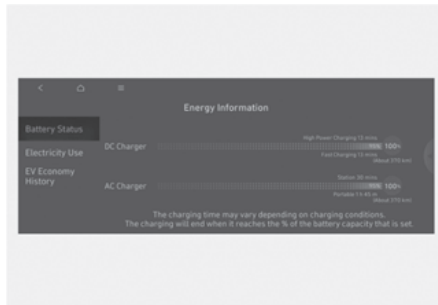

***i* Information**

- The distance to empty is calculated based on the electric energy economy history and outside temperature while driving. The distance may change if the driving pattern changes.
 - The distance to empty may vary depending on the change of the driving pattern even if the same target battery charge level is set.
-

Checking electricity use

On the Energy Information screen, select **Energy Consumption**.

- You can check the current energy consumption for each vehicle system.



No.	Name	Description
(1)	Electronics	Shows the power and energy consumption used by the vehicle system, including the instrument cluster, infotainment system (speaker and navigation), headlight, vehicle control unit, etc., and the percentage of the power vehicle system used in total power used since starting the vehicle.
(2)	Climate	Shows the power and energy consumption used by the air conditioner or heater and the percentage of the power climate system used in total power used since starting the vehicle.
(3)	Drive train	Shows the percentage of instantaneous and regenerative energy consumed by the motor to drive the vehicle and the percentage of the power driving system used in total power used since starting the vehicle.
(4)	Battery Care	Shows the momentary power and energy consumption used when increasing and cooling down the battery temperature to maintain optimal battery performance and the percentage of battery temperature control mode (Battery Care mode) used in the total power used since starting the vehicle.

Checking the electric energy economy history

On the Energy Information screen, select **EV Economy History**.

- You can check the history of electric energy economy with the date and distance of previous driving.

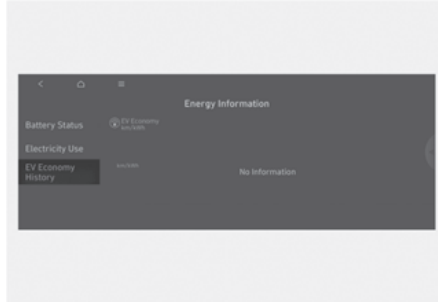

Setting the next departure time

You can set an anticipated departure time for scheduled charging and target temperature.

***i* Information**

- Scheduled charging and climate will be activated based on the departure time.
 - To use scheduled charging and climate function, the vehicle must be connected to the charger at the scheduled time.
 - The scheduled climate function directly uses the power of the connected charger. It can maintain a pleasant environment and enhance vehicle performance by controlling the temperature of the vehicle and the battery without using the high voltage battery power.
-

1. On the infotainment system, swipe left on the Home screen to display the All menus screen.
2. On the All menus screen, select **EV > Next Departure Time**.
3. Set the anticipated departure schedule.

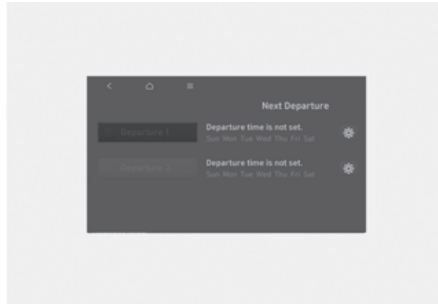

4. Set anticipated time the vehicle will departure after charging.

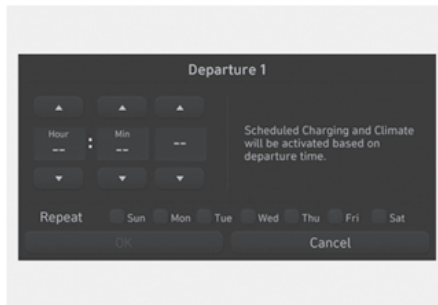

5. At **Repeat** option, select the day of the week to activate scheduled charging and target temperature for the departure time.

Setting scheduled charging and climate

You can set the date and time of when to charge the battery and the climate control temperature. Also, you may select the time to start charging using the off-peak time setting.

i Information

- Scheduled charging and climate can be activated based on the departure time.
- To use scheduled charging and climate function, the vehicle must be connected to the charger at the scheduled time.
- The scheduled climate function directly uses the power of the connected charger. It can maintain a pleasant environment and enhance vehicle performance by controlling the temperature of the vehicle and the battery without using the high voltage battery power.

Setting scheduled charging

Follow the instructions below to set the off-peak time and scheduled charging option.

1. On the infotainment system, swipe left on the Home screen to display the All menus screen.
2. On the All menus screen, **EV > Scheduled Charging and Climate > Scheduled Charging**.
3. Set the off-peak hours at **Start Time** and **End Time**.

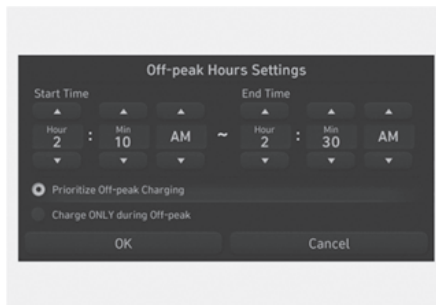

4. Select the charging option.
 - **Prioritize Off-peak Charging:** Charging is activated during the off-peak time. It may keep on charging pass off-peak time to reach the target battery charge level.
 - **Charge ONLY during Off-peak:** Charging is activated only during the off-peak time. It may not be able to reach the target battery charge level.
 - For more information about setting the target battery charge level, refer to the "Setting the target battery charge level" section in this chapter.

Setting a scheduled climate

Follow the instructions below to set the scheduled climate control temperature.

1. On the infotainment system, swipe left on the Home screen to display the All menus screen.
2. On the All menus screen, select **EV > Scheduled Charging and Climate > Scheduled Charging**.
3. Set the desired temperature.
 - The air conditioning system is activated at the departure time.
 - For more information about setting the departure time, refer to the "Setting the next departure time" section in this chapter.

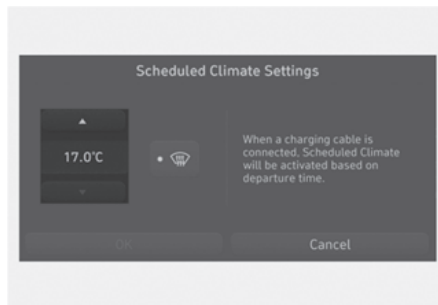

Setting a battery discharging limit when using Vehicle to Load (V2L)

Setting battery discharging limit (%) can prevent the battery from discharging when operating home appliances or electronic devices using the high voltage battery.

- For more information about V2L function, refer to the "Using V2L function" section in this chapter.

i Information

V2L is the system provides AC power using the high voltage battery for driving to operate several electronic devices. You can operate home appliances and electronic devices, or charge another electric vehicle in emergency using the charged electricity from the vehicle's battery while camping or doing other outdoor activities.

1. On the infotainment system, swipe left on the Home screen to display the All menus screen.
2. On the All menus screen, select **EV > Electricity use settings (V2L)**.
3. Set the desired battery discharging limit (%).
 - The battery discharging limit can only be set below the current battery charge.
 - When the battery charge reaches the set battery discharging limit, V2L function cuts off automatically.



Setting electric vehicle specialized functions

You can set various EV specialized functions such as target battery charge level, charging current, battery conditioning mode, and utility mode, from the **EV Settings** screen.

Setting the target battery charge level

Follow the instructions below to set the target battery charge level when charged with an AC charger or a DC charger.

1. On the infotainment system, swipe left on the Home screen to display the All menus screen.
2. On the All menus screen, select **EV** > **EV Settings** > **Max. % Charge**.

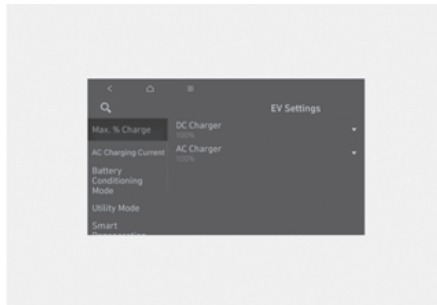

3. Set each of the target battery charge level for AC charging and DC charging.
 - The charging level can be changed by 10 %.
 - If the target battery charge level is lower than the current high voltage battery charge level, the battery will not be charged.

Setting the charging current

Follow the instructions below to set the charging current when using an AC charger or a portable charger.

1. On the infotainment system, swipe left on the Home screen to display the All menus screen.
2. On the All menus screen, select **EV** > **⚙️ (EV Settings)** > **AC Charging Current**
 - If the charging stops before reaching the target battery charge level while charging with an AC charger or a portable charger, reduce the size of the input current and retry charging.
 - The charging time may vary depending on which charging current is selected.

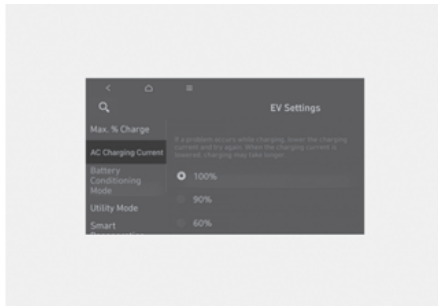

Setting battery conditioning mode ⁺if equipped

You can raise the battery temperature to maintain optimal driving performance and DC charging performance when the low temperature of the high voltage battery temperature may degrade the battery performance.

1. On the infotainment system, swipe left on the Home screen to display the All menus screen.
2. On the All menus screen, select **EV** > **EV Settings** and select **Battery Conditioning Mode**.
 - The battery temperature while driving will be maintained adequately.

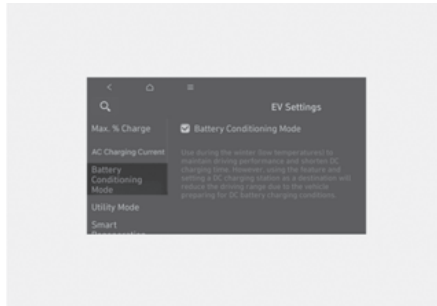

i Information

Be aware of the followings when using battery conditioning mode.

- The driving distance may be reduced as the energy is required to increase the battery temperature.
- If the battery temperature is low when the scheduled climate or remote climate control is operating, this mode is operated to improve the driving performance. However, if the battery charge level is low, the mode is not operated to ensure driving distance.
- If you set the destination as DC charging station while using the battery conditioning mode, the battery temperature will be optimized for charging and you can shorten the charging time as you can charge immediately after arrival.

Setting utility mode

Utility mode allows the high voltage battery to be used instead of the 12 V battery for purposes other than driving. You can use the audio and lights of the vehicle without worrying about discharging the battery and even use the indoor V2L feature.

i Information

- You cannot drive the vehicle while the utility mode is activated, and the gear can only be shifted to P (Park).
- You can use every electric device in the vehicle while the utility mode is activated.
- When the utility mode is activated, the Electronic Parking Brake (EPB) is applied automatically and you can release EPB by pressing the EPB switch if necessary.

Follow the instructions below to set the utility mode.

1. Check the operation conditions of the utility mode.
 - Check if the **READY** (ready indicator) is displayed on the instrument cluster.
 - Check if the reducer is shifted to P (Park).
2. On the infotainment system, swipe left on the Home screen to display the All menus screen.
3. On the All menus screen, select **EV** > **EV Settings** > **Utility mode** and select **Activate Utility mode** to activate the function (Utility Mode: ON).

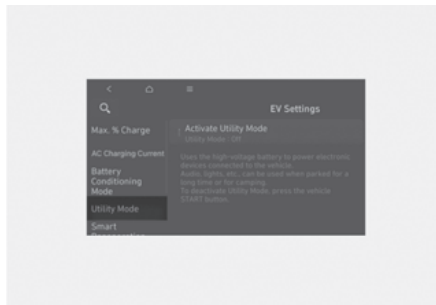

- The **READY** (ready indicator) will turn off and the **UTIL** (utility indicator) will illuminate on the instrument cluster and the EPB is applied.
- The utility mode can be deactivated by pressing the Start/Stop button to the OFF position.
- If you want to utilize V2L function in the vehicle while the utility mode is activated, refer to the "Using electricity inside the vehicle" in this chapter.

i Information

If the utility mode is not activated when the vehicle is in the ready (**READY**) mode and the gear is shifted to P (Park), inspect the operation status of EPB.

Searching for nearby charging stations

Around the course, around the current site, around the selected destination or charging stations of interest is searched. If you choose the charging station, the detailed information is provided.

***i* Information**

- When you sign up HYUNDAI BlueLink service, the available chargers at each charging station will be displayed.

1. On the infotainment system, swipe left on the Home screen to display the All menus screen.
2. On the All menus screen, select **EV** and select the charging station icon next to the vehicle

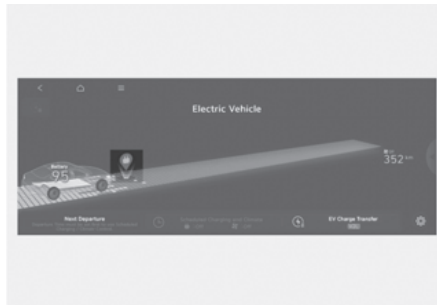

3. Choose a searching option from the list on the left side of the screen.

- You can choose among **Along Route**, **Near My Location**, **Near Destination**, **Near Center of Map** and **Favorite Station**.
- The direction(arrow) and distance, charger type, address, and location on the map of the charging stations corresponding to the selected option are displayed on the right side of the screen.



4. Select the charging station on the list and check the detailed information.

Using V2L function

With the Vehicle to Load (V2L) feature, you can turn on electronic devices by connecting them to the high voltage battery.

Safety precautions when using the V2L function

Before using V2L function, carefully read all the safety information below and follow precisely. Failure to do so may cause electric shock or fire and result in a serious injury, death, malfunction in your vehicle or property damage.

Precautions when using the V2L function

WARNING

- Do not use the V2L function if the V2L connector, charging inlet, power plug, or cable is damaged, corroded, or rusted.
 - Do not touch the V2L connector, charging inlet, or power plug with wet hands.
 - Do not use the V2L function if the connection part of the V2L connector and the charging inlet is loose.
 - Check if there is no water, dust, or other contaminants before connecting the connector and the plug. They may cause electric shock or fire.
 - Do not put metal objects or bare hands to the V2L connector or charging inlet.
 - For electric devices used outdoors in a vehicle, use a product with a waterproof function or use it in a waterproof environment. If rain or humidity intrude into electric devices, multi-outlets, extension cords, etc., it may cause electric shock or damage to the vehicle or the devices.
 - If there is a risk of lightning, do not use the V2L function outside the vehicle.
 - Do not use an electric heating appliances like electric kettle, toaster, or iron in the vehicle. Doing so may result in a fire and injury.
-

Precautions for operating the cooling fan

⚠ WARNING



When using the V2L, the cooling fan in the vehicle motor compartment can operate automatically even if the vehicle is turned off. Do not put your hand near the cooling fan in the V2L operating state.

Precautions for handling and using the V2L connector

⚠ CAUTION

- Do not remodel or disassemble the V2L connector. It may cause fire, electric shock, or injury. Damage to your vehicle caused by remodeling and disassembling is not covered by warranty.
 - When the power plug is connected or disconnected to the V2L connector or open or close the connector cover of the V2L, be careful not to be scratched on the hand or other parts of the body.
 - Be sure to disconnect the V2L connector from the vehicle when you are finished using V2L.
 - Do not charge the vehicle using the V2L connector. If you charge the vehicle arbitrarily by remodeling the power cable of the connector, etc., it may damage the vehicle.
 - Do not place objects on the V2L connector. It may damage the cable and cause electric shock or fire.
 - Do not drop the V2L connector or give a strong impact to it. Keep it clean in a dry place without water or humidity.
-

Precautions when using electric/electronic products

CAUTION

- Before using the product, check the precautions and how to use the product referring to the product manual.
 - Only use products that have obtained national safety certification.
 - Only use an electric device that does not exceed the maximum power capacity that the vehicle can supply. However, some of the electric devices may not operate normally even if the product has power consumption less than the maximum power capacity provided by the vehicle.
 - Electric devices that require high power during initial operation.
 - Measuring devices that need to process accurate data.
 - Electric devices that are sensitive to inverter type AC charger.
 - Do not use products that require a continuous power supply, such as medical equipment. The power supply may be interrupted depending on the vehicle's condition.
 - The V2L discharging mode is blocked automatically in case of overheating. When the discharging mode is blocked, check whether the V2L connector or power plug is contaminated, worn, corroded or broken.
 - If the temperature falls to a proper level after it is left unattended, you can use it again.
 - If overheating repeats when using a certain electric device, do not use the electric device.
 - Do not connect more than two extension cords or multi-outlet. Also, when using the extension cable, ensure using the cable without twist. Heat from the overlapped cable may cause fire.
 - Do not hang the home appliances onto the wire.
 - Do not use if the sheath of home appliance cables is damaged or broken.
 - Put the power plug fully when connecting to the power.
 - Only use the qualified plug with ground connection that meets the standard. Do not use worn, corroded, or broken plug or improper plug that does not meet the standard.
-

Using electricity outside the vehicle

Before using V2L function, carefully read all the safety information and precautions on "Safety precautions when using the V2L function" and follow the instructions.

Follow the instructions below to connect the V2L connector to the charging inlet on the vehicle and supply power to an electronic product.

1. Open the cover of the V2L connector.
2. Close the cover after connecting the plug of an electronic product to the power outlet of the connector.

WARNING

Some types of plugs may not fit into the outlet cover of the V2L connector, causing incomplete closing of the cover. Do not use the V2L connector on a rainy or snowy day if the outlet cover is not completely closed. There is a risk of fire and/or injury.

3. Open the connection terminal protection cap of the connector with the open switch pressed.
4. Open the charging door and connect the V2L connector to the charging inlet on the vehicle.
 - Connect the V2L connector to the charging inlet within 60 seconds after opening the charging door.
 - Time remaining until the battery level reaches the set value, and the distance to empty at the set value appears on the instrument cluster or the infotainment system.

5. Press the power switch of the V2L connector.

- The power is supplied and the indicator on the V2L connector is turned on.

i Information

- When the V2L connector is connected to the charging inlet of the vehicle, all doors and connectors will be automatically locked to prevent theft and separation. To disconnect the V2L connector, unlock the door and pull the connector with the open switch pressed.
 - Before using the V2L function, deactivate the scheduled climate setting referring to the "Setting scheduled charging and climate". The V2L function may be cut off depending on the scheduled climate setting.
 - To check and change the V2L setting, refer to the "Setting a battery discharging limit when using Vehicle to Load (V2L)" section in this chapter.
 - If an electric device that exceeds the maximum power capacity is connected, a warning message appears on the instrument cluster and the power supply shuts off immediately.
-

Using electricity inside the vehicle

You can connect home appliances or electric devices to the power outlet inside the vehicle and use them conveniently.

WARNING

Do not use an electric heating appliances like electric kettle, toaster, or iron in the vehicle. It may cause a fire and injury.

1. Press the Start/Stop button to the ON position or activate the utility mode.
 - For more information about the utility mode, refer to the "Setting utility mode" in this chapter.
2. Use the smart key to unlock the power outlet cover.



3. Open the power outlet cover by sliding it to the left, and connect the power plug of the electric device to the power socket.
 - Time remaining until the battery level reaches the set value, and the distance to empty at the set value appears on the instrument cluster or the infotainment system.

i Information

- The indicator on the power outlet indicates power supply status.



Indicator status	Description
Blue	Standby
Red	No power supply even the power outlet is connected.
Green	Normal power supply through the normal connection of the power outlet.

- V2L discharging mode shuts off if the vehicle is off using indoor V2L on the vehicle state of ON.
- Opening the charging door or connecting the V2L connector to the charging inlet, the V2L discharging mode shuts off.
- If you want to use the indoor and outdoor V2L simultaneously, firstly connect the V2L connector to the charging inlet and use the indoor V2L.
- When the high voltage battery charge level reaches the set discharging limit (%), the operation stops, and a warning message appears on the instrument cluster. If you want V2L operation, set the discharging limit (%) lower than the current battery charge.
 - For more information about the discharging limit, refer to the "Setting a battery discharging limit when using Vehicle to Load (V2L)" section in this chapter.
 - For more information about warnings, refer to the "Checking the warning and indicator lights" section in this chapter.

Solving V2L problems

If a problem occurs while using the V2L function, the V2L stops and a related messages appears on the instrument cluster.

Check the cause of the message and take an appropriate measure referring to the table below.

Message	Cause	Measure
V2L finished. Defined charge level reached	The high voltage battery level reaches the discharging limit set level.	To use the V2L continuously, make the discharging limit set level lower than the present battery level. (Refer to the "Setting a battery discharging limit when using Vehicle to Load (V2L)" section in this chapter.)
Energy consumption too high. V2L cancelled	An electrical appliance that exceeds the maximum power output the vehicle can supply is connected.	Check the total power consumption of the electrical appliance and replace it a product within the V2L maximum power output.
V2L conditions not met	V2L is stopped for the following reasons: <ul style="list-style-type: none"> • V2L connector switch off • V2L connector overheating • Opening the charging door while using the V2L indoor outlet 	Make sure there are no problems with the V2L connector and the vehicle indoor outlet.

Aux. Battery Saver+

The Aux. Battery Saver+ is a function that monitors the charging status of the 12 V battery. If the 12 V battery level is low, the main high voltage battery charges the 12 V battery.

Information

- The Aux. Battery Saver+ activates maximum of 20 minutes. If the Aux. Battery Saver+ function activates more than 10 times consecutively, in the Automatic Mode the function will stop activating, judging that there is a problem with the auxiliary battery. In this case, drive the vehicle for some period of time. The function will start activating if the auxiliary battery returns to normal.
- The Aux. Battery Saver+ function cannot prevent battery discharge if the auxiliary battery is damaged, worn out, used as a power supply or unauthorized electronic devices are used.
- If the Aux. Battery Saver+ function was activated the high voltage battery level may have decreased.

WARNING

When the function is activating, the high voltage electricity flows into the vehicle. Do not touch the high voltage electric wire (orange), connector, and all electric components and devices. This may cause electric shock and lead to injuries. Also, do not modify your vehicle in any way. This may affect your vehicle performance and lead to an accident.

Driving your electric vehicle

Check how to use the devices inside the vehicle that you must know for driving, such as starting, braking, and shifting the electric vehicle.

Starting and stopping the vehicle

Follow the instructions below to start or stop the vehicle.

CAUTION

- Always fasten the seat belt before starting the vehicle for safety.
 - Check if the EPB is applied before starting the vehicle.
-

Starting the vehicle

1. Holding the smart key, sit in the driver's seat.
2. Press the Start/Stop button while pressing the brake pedal.
 - On the instrument cluster, **READY**(ready indicator) is displayed.

Information

While the **READY** (ready indicator) is displayed, press the brake pedal, shift to D (Drive) or R (Reverse), and release the EPB and the brake pedal to start moving the vehicle forward or backward. You can start driving by pressing the accelerator pedal slowly and decelerate or stop by pressing the brake pedal.

Stopping the vehicle

1. Stop the vehicle completely by pressing the brake pedal.
2. Apply the EPB while pressing the brake pedal, and press the reduction gear's P button to shift to P (Park).
3. Press the Start/Stop button.
 - The **READY** (ready indicator) on the instrument cluster turns off.

Information

There are other Start/Stop button positions besides the ON/OFF. Use it appropriately paying attention to the discharging of the 12 V battery.

- **ACC:** The 12 V battery power is turned on, allowing some devices, such as infotainment system and air conditioning system to operate. Press the Start/Stop button when it is in the OFF position to turn on ACC.
 - **ON:** The 12 V battery power is turned on, allowing to check the instrument cluster and use all the electric devices inside the vehicle. Press the Start/Stop button when it is in the ACC position to turn it ON.
-

Understanding virtual engine sound system

Electric vehicles do not use an internal combustion engine, so there is no engine noise while driving. The Virtual Engine Sound System (VESS) generates engine sound to make pedestrians aware of the approaching vehicle when driving.

- If the vehicle is in the ready (**READY**) mode and the gear is not in P (Park), the VESS will be operated.
- When the gear is shifted to R (Reverse), an additional warning sound will be heard.

CAUTION

- Be aware that the vehicle does not make engine noise while driving.
 - Pay attention to the surrounding environment and drive carefully.
 - After parking or waiting for a traffic light, please check around for children, or other obstacles before departure.
 - When reversing, check directly behind you before driving. Pedestrians may not be able to recognize vehicle sounds.
-

Checking electric vehicle driving information

During vehicle operation, the instrument cluster displays the main information, such as distance to empty, real-time energy status, battery charge level, and warning messages, via the user interface and indicators.

Factors affecting the distance to empty

The distance to empty refers to the distance that can be driven by the current charged battery level and is displayed on the bottom of the instrument cluster while driving the electric vehicle.

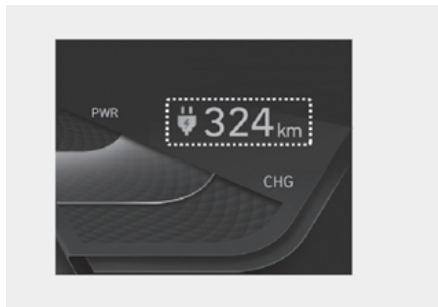

The distance to empty varies depending on many factors such as driving habits, power usage, driving conditions, and high voltage battery. The distance to empty may be increased or decreased than the certified figures as it reflects all the factors comprehensively. Check the distance to empty considering the following:

- The driving habits: The driving speed and tendency of accelerating and decelerating. High-speed driving or frequent accelerating and decelerating reduces the distance to empty.
- The power usage: Additional power use, such as the air conditioner, heater, lamps, etc. As the power usage increases, the distance to empty reduces.
- The driving conditions: The weather, temperature, and terrain. If you drive in snow/rain/strong wind or low temperature, the distance to empty will be reduced. The distance to empty will also be reduced when driving uphill or on slippery or rough roads.
- The electric energy: Proportional to the State of Charge (SOC), but may vary depending on the battery temperature and the State of Health (SOH) of a battery.

Change in the distance to empty when 100 % charged

In case the distance to empty has been reduced due to learning of the driving habit or the driving conditions, you can increase the distance to empty again by continuously driving following the "Tips for enhancing the distance to empty".

- Resetting the previously learned driving patterns at the service center may increase the distance to empty displayed on the bottom of the instrument cluster, but it does not increase the actual distance to empty. The distance to empty may not be accurate until the learning proceeds.
- If the high voltage battery temperature is low in winter, the distance to empty reduces but it is not a permanent change. The distance to empty will increase again once the temperature rises.
- If you reduce the power usage, the distance to empty will increase.
- Natural degradation may occur with the high voltage battery depending on the number of years the vehicle is used. This may reduce the distance to empty.

When setting a destination

When the destination is set, the distance to empty may change because the distance to empty is recalculated using the information of the destination instead of the learned electric energy economy history.

***i* Information**

The distance to empty may vary significantly based on traffic conditions or driving speed.

Tips for enhancing the distance to empty

The distance to empty vary depending on the charge level of the high voltage battery, weather, temperature, duration of the battery use, terrain, driving habits, etc.

You can increase the distance to empty by driving the vehicle following the instructions below.

- The air resistance increases rapidly as the electric vehicle drives faster, so avoid speeding to increase the distance to empty and the electric energy economy.
- Rapid acceleration consumes a lot of driving energy and rapid deceleration limits the regenerative braking. Gradually depress and release the accelerator pedal when accelerating or decelerating to maintain speed.

- If you operate the air conditioner or heater too much, the high voltage battery will use excessive electricity. This may reduce the distance to empty. Therefore, set the cabin temperature to 22 °C AUTO level 2. Various assessment tests have been used to verify that this setting maintains optimal energy consumption rates. Especially in winter, reducing heating and using heated seats instead can significantly increase the distance to empty. Turn off the air conditioner or heater if you do not need them.
- When using the air conditioner or heater, the energy consumption is reduced if recirculation mode is selected instead of fresh mode. Fresh mode requires a large amount of energy consumption as the outside air has to be reheated or cooled.
- Close the windows while driving. Driving with the windows open increases air resistance and the usage of the air conditioner or heater.
- When using the air conditioner or heater while driving alone, use the DRIVER ONLY function.
- Always maintain specified tire pressures and use tires for electric vehicles.
- Do not use unnecessary electrical components while driving.
- Do not load unnecessary items in the vehicle.
- Do not mount parts that may increase air resistance.

When the distance to empty is insufficient

- When the battery warning indicator is displayed, immediately charge the vehicle at a nearby charging station.
- Drive energy efficiently following the "Tips for enhancing the distance to empty."
- When the battery level is 0 %, do not try to drive. Move to a safe place and call for help.

Checking the real-time energy status (CHARGE/POWER gauge)

The CHARGE/POWER gauge displays the charging and discharging status of the electric energy produced by the regenerative braking and the energy consumption of the electric motor.

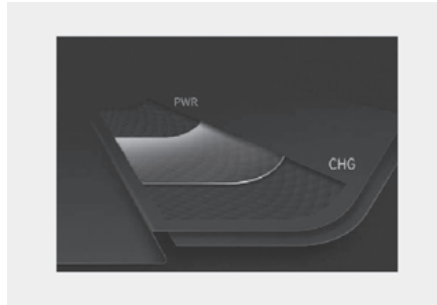

- **CHARGE:** Shows the charging status of the electric motor when vehicle is decelerating or driving on a downhill road (being charged by the regenerative brakes). The more electric energy is charged, the lower the gauge level.
- **POWER:** Shows discharging status of the electric motor when vehicle is accelerating or driving on an uphill road. The more electric energy is discharged (used), the higher the gauge level.

Checking the State of Charge (SOC)

The SOC indicator is displayed at the bottom of the CHARGE/POWER gauge and shows the charge level of the high voltage battery as a percentage. The lower the number, the more the vehicle needs to be charged, and 100 % indicates a full charge.

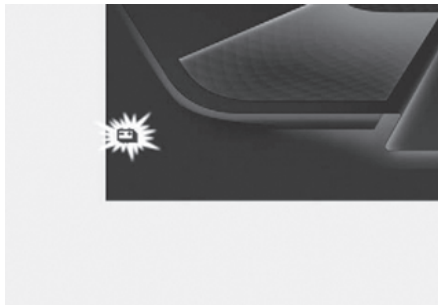
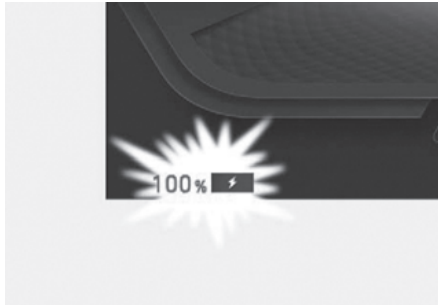

- When the remaining battery of the high voltage battery is lower than 10 %, the warning light will be displayed.
- When the warning light is displayed, charge the vehicle.

***i* Information**

- To find a nearby charging station, refer to the "Searching for nearby charging stations" section in this chapter.
 - Check if the SOC is enough before driving on highways or motorways.
 - After the warning light is displayed, immediately charge the vehicle at a nearby charging station. The vehicle may not operate properly depending on the driving speed, weather, and other driving conditions.
-

Checking the warning and indicator lights



The warning and indicator lights are displayed in the middle of the instrument cluster before or while driving, depending on the status of the electric vehicle. Understand the meaning of the warning and indicator lights referring to the instructions below and drive safely.

CAUTION

If the warning light illuminates while driving or does not go off, we recommend that you have the vehicle inspected by an authorized HYUNDAI dealer.

Checking the warning lights

Check the cause of the warning lights referring to the table below and take appropriate measures.

Warning light	Cause	Measure
Service warning light 	This warning light illuminates: <ul style="list-style-type: none"> • When there is a problem with related parts of the electric vehicle control system, such as sensors, etc. • When an actuator, electric compressor for air conditioning, etc. malfunctions. 	In a normal condition, it illuminates for about 3 seconds when the Start/Stop button is in the ON position and then goes off. <ul style="list-style-type: none"> • When the warning light illuminates while driving, or does not go off after starting the vehicle, we recommend that you have your vehicle inspected by an authorized HYUNDAI dealer.
Power down indicator light 	This warning light illuminates: <ul style="list-style-type: none"> • When the high voltage battery level is too low or voltage is decreasing. (Output limit occurs when the charge level is insufficient.) • When the temperature of the high voltage battery is too high or too low. • When the driving system temperature is overheated and requires protection. 	If it illuminates alone, it is not failure. <ul style="list-style-type: none"> • If both power down indicator light and service warning light illuminate at the same time, we recommend that you have the vehicle inspected by an authorized HYUNDAI dealer. • When the indicator is illuminating, immediately charge the vehicle. The driving speed may be limited and the vehicle may not properly drive uphill.
High voltage battery level warning light 	This warning light illuminates when the high voltage battery level is low.	Immediately charge the vehicle. The vehicle can drive an additional 30-50 km. <ul style="list-style-type: none"> • The actual distance to empty depends on the driving conditions.

Warning light	Cause	Measure
<p>Regenerative brake warning light</p> 	<p>This warning light illuminates when the regenerative brake does not operate and the brake does not perform well due to the malfunction of the brake system.</p>	<p>We recommend that you visit an authorized HYUNDAI dealer and have the vehicle inspected and repaired.</p> <ul style="list-style-type: none"> The operation of the brake pedal may feel deeper than normal or the braking distance may increase.

Checking the indicator lights

Check the meaning of the indicator lights referring to the table below and take appropriate measures if necessary.

Indicator light	Meaning
<p>Charging indicator light</p> 	<p>Indicates the charging connector is connected to the high voltage battery.</p> <ul style="list-style-type: none"> When the charging connector is connected, it turns green.
<p>Ready indicator READY</p>	<p>Illuminates when the electric vehicle is ready to be driven, and indicates that the vehicle is operable.</p> <ul style="list-style-type: none"> When the vehicle malfunctions, the indicator goes off or blinks. If the indicator is turned off or blinks, we recommend that you have the vehicle inspected and repaired by an authorized HYUNDAI dealer.

Checking warning messages

Check the meaning of the warning messages referring to the table below and take appropriate measures.

 WARNING
<ul style="list-style-type: none"> Do not drive with a warning message displayed. If a warning message does not go off after taking measures, we recommend that you have the vehicle immediately inspected and repaired by an authorized HYUNDAI dealer.

Warning message	Cause	Measure
Low EV battery	<p>The high voltage battery level reaches below 20 %.</p> <ul style="list-style-type: none"> The warning light on the instrument cluster turns on simultaneously. 	<p>Charge the vehicle immediately.</p>
Charge immediately. Power limited	<p>The high voltage battery level reaches below 10 %.</p> <ul style="list-style-type: none"> The warning light on the instrument cluster turns on simultaneously. The vehicle's power may be reduced to minimize the energy consumption of the high voltage battery. 	<p>Charge the battery immediately.</p>
Check electric vehicle system	<p>There is a problem with the electric vehicle control system.</p>	<ul style="list-style-type: none"> Do not drive when the warning message is displayed. We recommend that you immediately tow the vehicle to an authorized HYUNDAI dealer and have it inspected and repaired.
Power limited	<p>This warning message is displayed when the power of the vehicle is limited to ensure the safety of high-powered components for the reasons below:</p> <ul style="list-style-type: none"> The high voltage battery level is too low or voltage is decreasing. The temperature of the high voltage battery is too high or too low. When the driving system is overheated and requires protection. 	<p>If it illuminates alone, it did not fail.</p> <ul style="list-style-type: none"> Charge the vehicle is the charge level is low. If both power down indicator light and service warning light illuminate at the same time, we recommend that you have the vehicle inspected by an authorized HYUNDAI dealer. Do not accelerate or start the vehicle suddenly when the warning message is displayed. Be careful when the power down indicator is displayed. The vehicle may not properly drive uphill and roll back on a slope.

Warning message	Cause	Measure
<p>Low EV battery temperature. Power limited</p>	<p>If you start or turn off the vehicle when the outside temperature is low, both warning messages will be displayed to protect electric vehicle system.</p> <ul style="list-style-type: none"> If the high voltage battery charge level is low and parked outside for a long time, vehicle power could be limited due to the low battery temperature. 	<ul style="list-style-type: none"> Charging the battery before driving helps increase power. If these warning messages are still displayed even after the ambient temperature has increased, we recommend that you have the vehicle inspected and repaired by an authorized HYUNDAI dealer.
<p>EV Battery Overheated! Stop vehicle</p>	<p>The high voltage battery temperature is too high.</p>	<ul style="list-style-type: none"> Stop the vehicle in a safe place and turn off the Start/Stop button and wait until the battery temperature decreases. If these warning messages are still displayed even after turning off the vehicle and waiting for a sufficient time, we recommend that you immediately tow the vehicle to an authorized HYUNDAI dealer and have it inspected and repaired.
<p>Stop vehicle and check power supply</p>	<p>A failure occurs in the power supply system.</p>	<p>Immediately stop the vehicle in a safe place. We recommend that you tow the vehicle to an authorized HYUNDAI dealer for inspection and maintenance.</p>
<p>Unplug vehicle to start</p>	<p>You have started the vehicle with the charging connector plugged in.</p>	<p>Unplug the charging cable and start the vehicle.</p>
<p>Charging Door Open</p>	<p>You have started the vehicle with the charging door opened.</p>	<p>Check if the charging door is completely closed after charging the vehicle.</p>

Warning message	Cause	Measure
<p>Charging Stopped. Check the AC charger</p>	<p>These warning messages are displayed when charging is stopped for the reasons below:</p> <ul style="list-style-type: none"> • There is a problem with the external AC charger or DC charger. • The external AC charger stopped the charging. • The charging cable is damaged. 	<ul style="list-style-type: none"> • Check whether there is any problem with the external AC or DC charger and charging cable. • Charge the vehicle with an AC charger that has been approved for proper operation or a genuine HYUNDAI portable charger. • If the same problem occurs, we recommend that you have the vehicle inspected by an authorized HYUNDAI dealer.
<p>Charging Stopped. Check the cable connection</p>	<p>These warning messages are displayed when charging is stopped for the reasons below:</p> <ul style="list-style-type: none"> • The charging connector is not correctly connected to the charging inlet. • The unlock button on the charging connector is pressed. 	<ul style="list-style-type: none"> • Separate the charging connector from the vehicle and reconnect it. • Check whether there is any problem, such as external damage, foreign substances, etc., with the charging connector and charging inlet. • Charge the vehicle with a charger that has been approved for proper operation or a genuine HYUNDAI portable charger. • If the same problem occurs, we recommend that you have the vehicle inspected by an authorized HYUNDAI dealer.

Countermeasures for accidents or fire

When an accident occurs while driving the electric vehicle, turn on the hazard warning flasher, move the vehicle to a safe place, and do not let other people approach the site.

WARNING

When an accident occurs, and the high voltage battery is damaged, harmful gas and electrolytes may leak.

- Be careful not to touch the leaked liquid.
 - When you suspect leakage of inflammable gas and other harmful gases, open the windows and immediately evacuate to a safe location.
 - If any leaked fluid comes in contact with your eyes or skin, immediately clean the affected area thoroughly with tap water or saline solution and have doctors inspect it as soon as possible.
-

If the electric vehicle catches fire

If a fire occurs, evacuate to a safe place and do not let other people approach the site.

- Contact the fire department, report an electric vehicle fire, and then follow its instructions.

CAUTION

- If a fire occurs, evacuate to a safe place and wait until the firefighters arrive.
 - If the lower part of the vehicle where the high voltage battery is located catches fire, large amount of water must be supplied continuously for a long time to completely extinguish the fire. It is hard to extinguish the fire without sufficient water and appropriate fire extinguishers. If you approach the vehicle carelessly, it may cause accidents, such as electric shock, and result in serious injury.
-

If the electric vehicle is submerged

If the electric vehicle is submerged while driving, follow the instructions below:

- Immediately turn off the vehicle and evacuate to a safe place with your key.
- Contact the emergency rescue service such as a fire department, or an authorized HYUNDAI dealer.

WARNING

Never touch the submerged electric vehicle. This may lead to an accident such as an electric shock or fire.

If the electric vehicle needs towing

If towing is required, lift all wheels to tow. Towing with the wheels on the ground may damage the vehicle's motor components.

CAUTION

Contact the fire department when towing the vehicle after a fire. When a vehicle fire occurs due to the battery, there is a risk of a second fire.

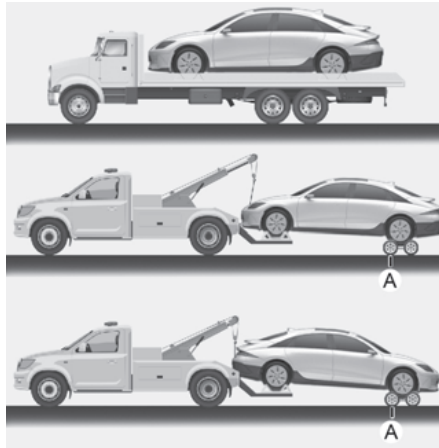

[A] Dollies

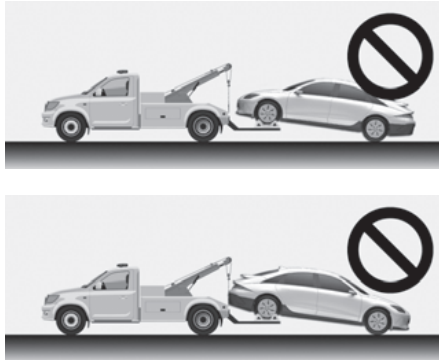

Other precautions for electric vehicle accidents

CAUTION

- Be extremely cautious for electricity safety. An electric shock accident may occur due to a short circuit in high voltage power.
 - When you paint or apply heat treatment to the vehicle as a result of an accident, the performance of the high voltage battery can be reduced. If heat treatment is required, we recommend that you contact an authorized HYUNDAI dealer.
 - Use or install only genuine parts. Third-party parts or modified parts may damage the electric power system
-

2. Vehicle information

- Exterior overview (Front View) 2-2
- Exterior overview (Rear View) 2-3
- Interior overview (Left-hand drive) 2-4
- Interior overview (Right-hand drive)..... 2-5
- Center Console Overview (Left-hand drive)..... 2-6
- Center Console Overview (Right-hand drive) 2-8
- Steering Wheel Control Overview 2-10
- Motor Compartment Overview 2-11
- Dimensions 2-12
- Electric vehicle specifications 2-13
- Bulb wattage 2-14
- Tires and wheels 2-15
- Load and speed capacity tires (for Europe)..... 2-16
- Air conditioning system 2-16
- Vehicle weight and luggage volume 2-17
- Available front trunk weight 2-17
- Recommended lubricants and capacities 2-18
- Vehicle Identification Number (VIN) 2-19
- Vehicle certification label 2-19
- Tire specification and pressure label 2-20
- Motor number 2-20
- Air conditioner compressor label 2-21
- Declaration of conformity 2-21
- Open source software notice 2-21

Exterior overview (Front View)

Front view

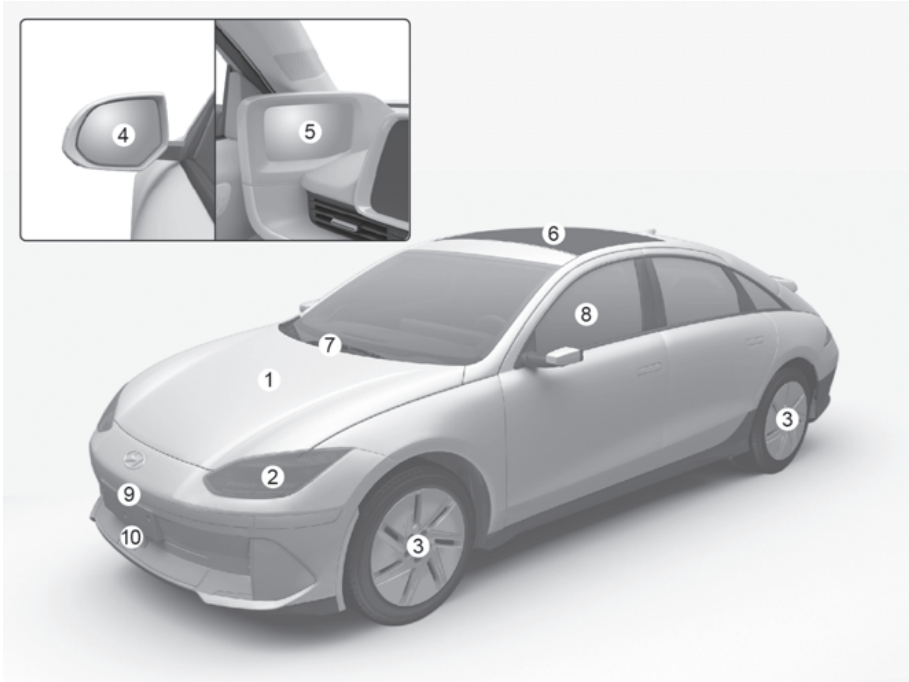

The actual shape may differ from the illustration.

(1) Hood	5-52
(2) Headlight	9-48
(3) Tires and wheels	9-23
(4) Outside rearview mirror	5-33
(5) Digital side mirror	5-37
(6) Wide sunroof.....	5-48
(7) Front windshield wiper blades	9-16
(8) Windows.....	5-43
(9) Wide-front view camera	7-124
(10)Front radar	7-7

Exterior overview (Rear View)

Rear view



The actual shape may differ from the illustration.

(1) Door	5-13
(2) Electric charging door	5-63
(3) Rear light	9-56
(4) Trunk.....	5-55
(5) Trunk open/close button	5-56
(6) High mounted stop light	9-56
(7) Antenna	5-121
(8) Wide-rear view camera.....	7-120
(9) Backup light/Rear fog light*	9-56

*: if equipped

Interior overview (Left-hand drive)

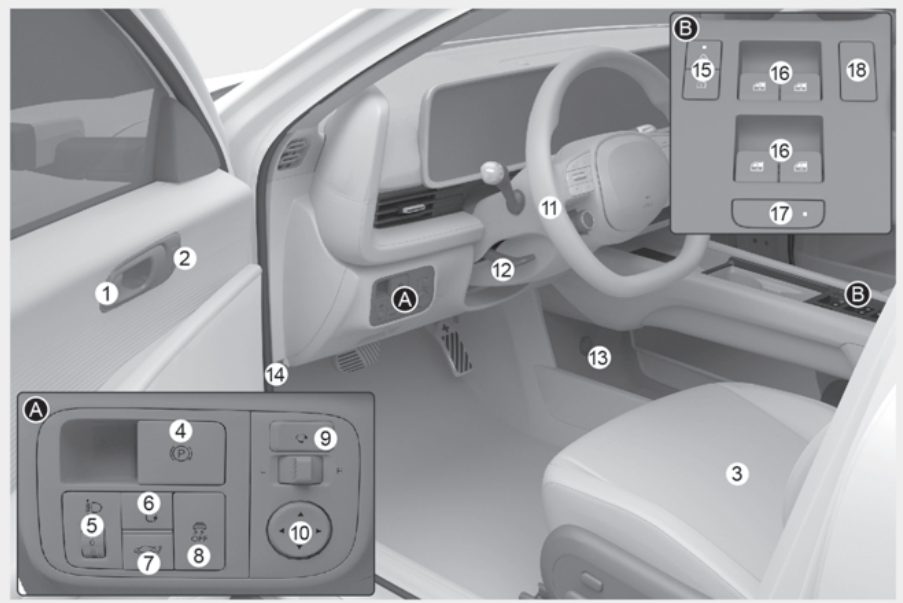

The actual shape may differ from the illustration.

(1) Inside door handle	5-17
(2) Integrated memory system	5-25
(3) Seat	3-4
(4) EPB (Electronic Parking Brake) switch	6-27
(5) Headlight leveling device	5-73
(6) Charging door open/close button	5-63
(7) Power trunk open/close button	5-56
(8) ESC (Electronic Stability Control) OFF button	6-37
(9) Outside rearview mirror folding button	5-34
(10) Outside rearview mirror control switch	5-34
(11) Steering wheel	5-28
(12) Steering wheel tilt/telescopic lever	5-29
(13) Power outlet	5-115
(14) Hood release lever	5-52
(15) Central door lock switch	5-18
(16) Power window switches	5-45
(17) Power window lock button	5-46
(18) AUTO Hold button	6-32

Interior overview (Right-hand drive)

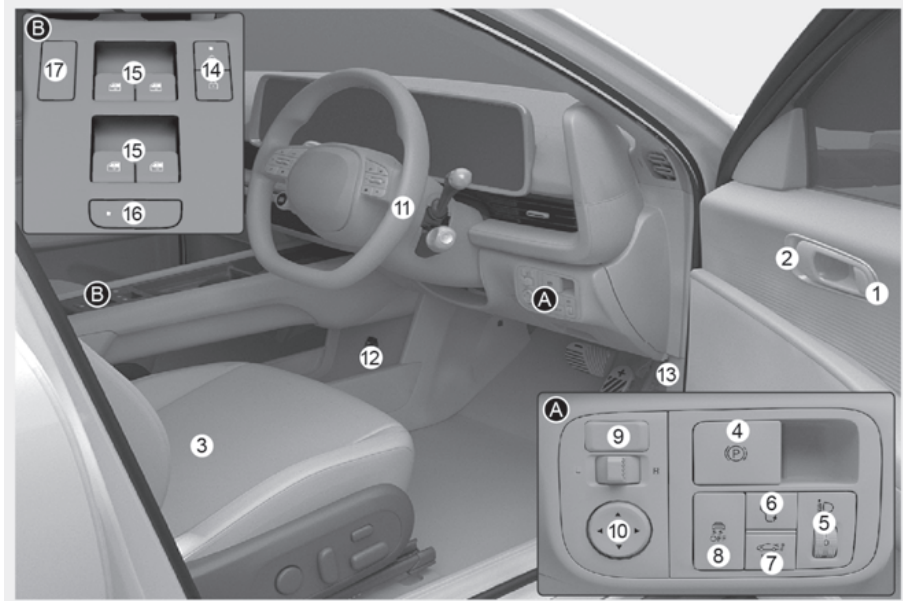

The actual shape may differ from the illustration.

(1) Inside door handle.....	5-17
(2) Integrated memory system	5-25
(3) Seat.....	3-4
(4) EPB (Electronic Parking Brake) switch.....	6-27
(5) Headlight leveling device	5-73
(6) Charging door open/close button.....	5-63
(7) Power trunk open/close button	5-56
(8) ESC (Electronic Stability Control) OFF button.....	6-37
(9) Outside rearview mirror folding button	5-34
(10) Outside rearview mirror control switch	5-34
(11) Steering wheel	5-28
(12) Power outlet.....	5-115
(13) Hood release lever.....	5-52
(14) Central door lock switch	5-18
(15) Power window switches	5-45
(16) Power window lock button	5-46
(17) AUTO Hold button	6-32

Center Console Overview (Left-hand drive)

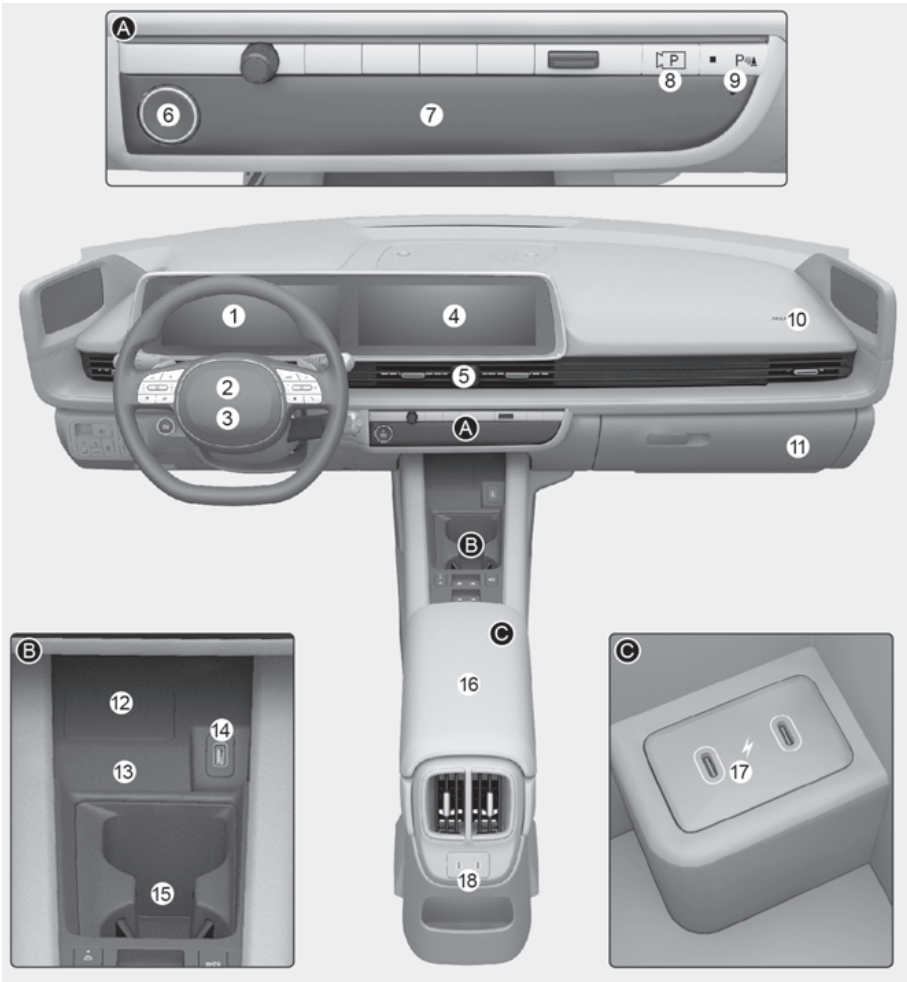

The actual shape may differ from the illustration.

(1) Instrument cluster	4-2
(2) Horn	5-30
(3) Driver's front airbag	3-54
(4) Infotainment system	5-121
(5) Hazard warning flasher button	8-3
(6) Start/Stop button	6-4
(7) Automatic climate control system	5-89
(8) Parking/View button	7-121

(9) Parking Safety button.....	7-142
(10) Passenger's front airbag	3-54
(11) Glove box	5-113
(12) Wireless charging system pad.....	5-117
(13) Wireless charging system	5-117
(14) USB port	5-116
(15) Cup holder.....	5-113
(16) Center console.....	5-112
(17) USB charger	5-116
(18) USB charger (Rear seat).....	5-116

Center Console Overview (Right-hand drive)



The actual shape may differ from the illustration.

(1) Instrument cluster	4-2
(2) Horn	5-30
(3) Driver's front airbag	3-54
(4) Infotainment system	5-121
(5) Hazard warning flasher button	8-3
(6) Start/Stop button	6-4
(7) Automatic climate control system	5-89
(8) Parking/View button	7-121

(9) Parking Safety button.....	7-142
(10) Passenger's front airbag	3-54
(11) Glove box	5-113
(12) Wireless charging system pad.....	5-117
(13) Wireless charging system	5-117
(14) USB port	5-116
(15) Cup holder.....	5-113
(16) Center console.....	5-112
(17) USB charger	5-116
(18) USB charger (Rear seat).....	5-116

Steering Wheel Control Overview

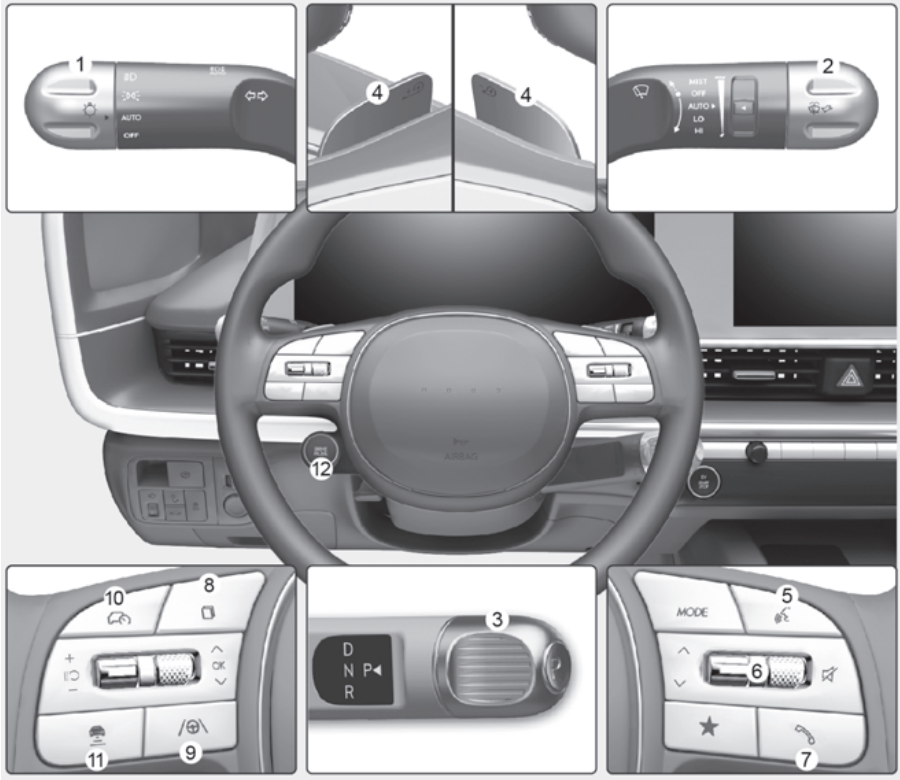

The actual shape may differ from the illustration.

(1) Lighting control lever	5-69
(2) Wiper and washer control lever.....	5-86
(3) Rotary shifter(Rotary gear shift dial).....	6-9
(4) Paddle shifter	6-15
(5) Voice recognition button	5-123
(6) Steering wheel audio controls.....	5-121
(7) Bluetooth wireless technology hands-free button	5-123
(8) Cluster display control	4-34
(9) Lane Driving Assist button	7-35
(10)Driving Assist button	7-81
(11) Vehicle Distance button.....	7-82
(12)Drive mode button	6-48

Motor Compartment Overview

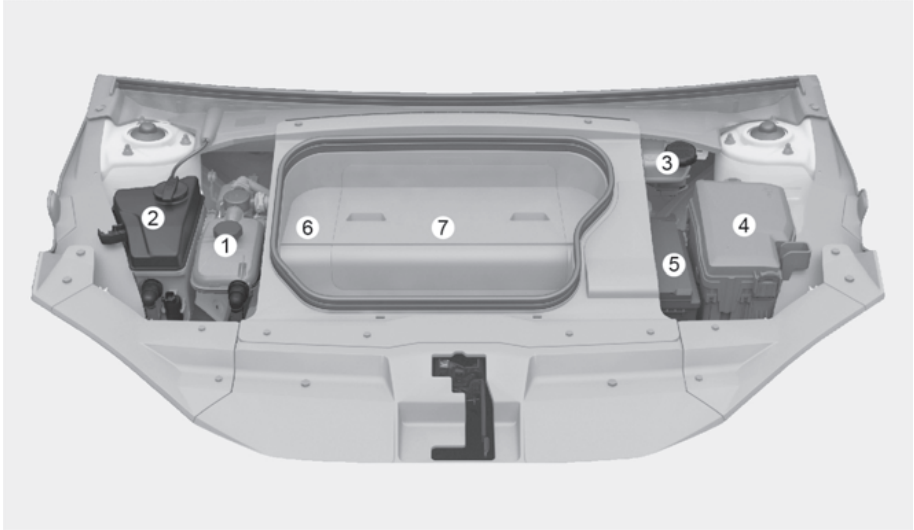

The actual motor compartment in the vehicle may differ from the illustration.

(1) Coolant reservoir	9-12
(2) Windshield washer fluid reservoir	9-14
(3) Brake fluid reservoir	9-13
(4) Fuse box	9-33
(5) Battery (12 V)	9-18
(6) Front trunk	5-53
(7) Cabin air filter	9-15

Dimensions

Items		mm (in.)	
Overall length		4,855 (191.14)	
Overall width		1,880 (74.02)	
Overall height		1,495 (58.86)	
Tread	Tire size	Front	Rear
	18 in.	1,635 (64.37)	1,644 (64.72)
	20 in.	1,630 (64.17)	1,639 (64.53)
Wheelbase		2,950 (116.14)	

Electric vehicle specifications

Items		Standard type	Extended type	
		2WD	2WD	AWD
Motor	Max. output (kW)	107	168	74+165
	Max. torque (Nm)	350	350	255+350
Battery (Lithium-ion)	Capacity (kWh)	53	77.4	77.4
	Power output (kW)	173	277	277
	Voltage (V)	480	697	697
Charger (OBC: On-Board Battery Chargers)	Max. output (kW)	11	11	11

Bulb wattage

Light bulb		Bulb type	Wattage
Front	Headlight	Low	LED
		High	LED
	Turn signal light		LED
	Position light		LED
	Daytime Running light (DRL)		LED
	Front trunk light		LED
	Side repeater light		LED
Rear	Stop light		LED
	Tail light		LED
	Turn signal light		LED
	Backup light		LED
	License plate light		LED
	Fog light		LED
	High mounted stop light		LED
Interior	Map lamp		LED
	Room lamp		LED
	Vanity mirror lamp		LED
	Glove box lamp		LED
	Door mood lamp		LED
	Luggage compartment lamp		LED

Tires and wheels

Items	Tire size	Wheel size	Inflation pressure kPa (psi)				Wheel lug nut torque kgf-m (lbf-ft, N-m)
			Normal load		Maximum load		
			Front	Rear	Front	Rear	
Full size tire	225/55R18	7.5J X 18	250 (36)	250 (36)	260 (38)	290 (42)	11-13 (79-94, 108-127)
	245/40R 20	8.5J X 20					

NOTICE

- Ambient temperature affects the tire pressure (about 7 kPa (1 psi) for every 7 °C (12 °F) change). If colder temperatures are anticipated, it is permissible to increase cold tire inflation pressure by up to 20 kPa (3 psi) over the specification. If extreme temperature changes are expected, be sure to check and adjust tire pressure accordingly.
- Tire inflation pressure decreases with higher elevation, and increases with lower elevation (about 10 kPa (2.4 psi) for every kilometer (or mile) elevation change). Be sure to check and adjust tire pressure accordingly when driving through changing elevations.
- Do not exceed the maximum inflation pressure, as found on the sidewall of the tire(s).

CAUTION

When replacing tires, ALWAYS use the same size, type, brand, construction and tread pattern supplied with the vehicle. If not, it can damage the related parts or make it work irregularly.

Load and speed capacity tires (for Europe)

Items	Tire size	Wheel size	Load capacity		Speed capacity	
			LI ^{*1}	kg	SS ^{*2}	km/h
Full size tire	225/55R18	7.5J X 18	98	750	W	270
	245/40R20	8.5J X 20	99	775	Y	300

*1 LOAD INDEX

*2 SPEED SYMBOL

Air conditioning system

Item		Weight of volume	Classification
Refrigerant	Type A	With heat pump	900±25 g (32±0.9 oz.)
		Without heat pump	700±25 g (25±0.9 oz.)
	Type B	With heat pump	950±25 g (34±0.9 oz.)
		Without heat pump	750±25 g (26±0.9 oz.)
Compressor lubricant	Heat pump		190±10 g (6.11±0.35 oz.)
	Without heat pump		150±10 g (5.29±0.35 oz.)

We recommend that you contact an authorized HYUNDAI dealer for more information.

Vehicle weight and luggage volume

Gross vehicle weight		Luggage volume
Standard type	Extended type	
2WD: 2280 kg (5027 lbs.)	2WD: 2410 kg (5313 lbs.) AWD: 2520 kg (5556 lbs.)	401 ℓ (14.2 cu ft.)

Available front trunk weight

2WD	AWD
25 kg (55 lbs.)	10 kg (25 lbs.)

Available front trunk weight depends on the specifications.

Recommended lubricants and capacities

To help achieve proper vehicle performance and durability, use only lubricants of the proper quality.

These lubricants and fluids are recommended for use in your vehicle.

Lubricant			Volume	Classification	
Reduction gear fluid	2WD	Rear	3.4-3.5 ℓ (3.6-3.7 US qt.)	HK ATF 65 SP4M-1	
	AWD	Front	3.2-3.3 ℓ (3.4-3.5 US qt.)		
		Rear	3.4-3.5 ℓ (3.6-3.7 US qt.)		
Coolant	Standard type	with heat pump	2WD	17.38 ℓ (18.37 US qt.)	Mixture of antifreeze and water (Phosphate-base d Ethylene glycol coolant Battery for aluminum radiator)
			AWD	17.59 ℓ (18.59 US qt.)	
		without heat pump	2WD	16.75 ℓ (17.7 US qt.)	
			AWD	17.08 ℓ (18.05 US qt.)	
	Extended type	with heat pump	2WD	19.38 ℓ (20.48 US qt.)	
			AWD	19.64 ℓ (20.75 US qt.)	
		without heat pump	2WD	18.75 ℓ (19.81 US qt.)	
			AWD	19.13 ℓ (20.21 US qt.)	
Brake fluid			about 700 cc (24 oz.)	SAE J1704 DOT-4 LV, FMVSS 116 DOT-4, ISO 4925 CLASS-6	

Vehicle Identification Number (VIN)

Frame number

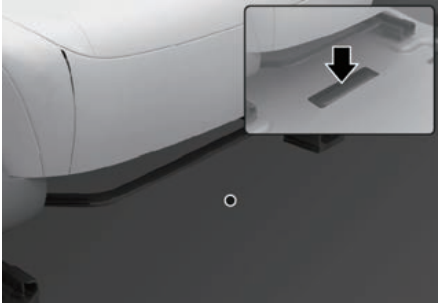

The vehicle identification number (VIN) is the number used in registering your vehicle and in all legal matters pertaining to its ownership, etc.

The number is punched on the floor under the right front seat. To check the number, open the cover.

VIN label (if equipped)

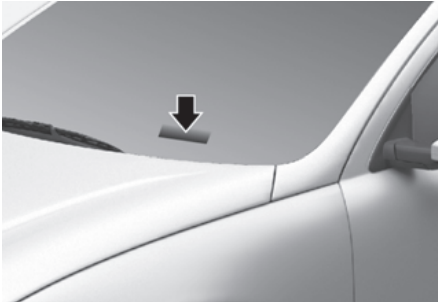

The VIN is also on a plate attached to the top of the left side dashboard. The number on the plate can easily be seen through the windshield from outside.

Vehicle certification label



The vehicle certification label attached on the driver's (or front passenger's) side center pillar gives the vehicle identification number (VIN).

Tire specification and pressure label



The tires supplied on your new vehicle are chosen to provide the best performance for normal driving.

The tire label located on the driver's side center pillar gives the tire pressures recommended for your vehicle.

Motor number

2WD/AWD

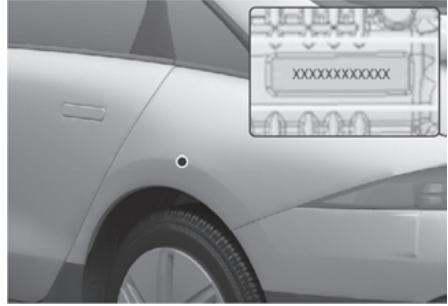

AWD

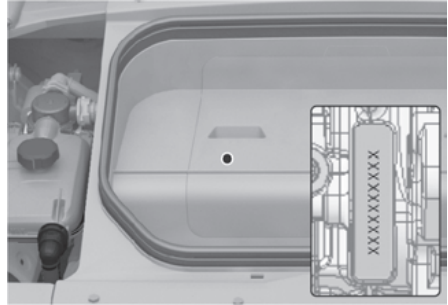

The motor numbers can be checked at the bottom of the vehicle.

Air conditioner compressor label

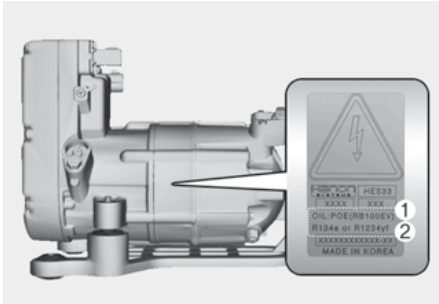

A compressor label informs you the type of compressor your vehicle is equipped with such as model, supplier part number, production number, refrigerant (1) and refrigerant oil (2).

Declaration of conformity

+ if equipped

Example



The radio frequency components of the vehicle comply with requirements and other relevant provisions of Directive 1995/5/EC.

Further information including the manufacturer's declaration of conformity is available on HYUNDAI web site as follows;

<http://service.hyundai-motor.com>

Open source software notice

This vehicle contains software with open source licenses. Open source software information including the source code, copyright notices and referred license terms may be obtained on the website <https://www.hyundai.com/worldwide/opensource>

HYUNDAI Motor Company will provide the open source code to you in storage medium such as CD-ROM for minimum charge covering the cost of performing source distribution upon email request to opensource@hyundai.com within a period of 3 years from the date of product purchase.

3. Seats & Safety system

- Important safety precautions 3-2
 - Always wear your seat belt..... 3-2
 - Restrain all children 3-2
 - Airbag hazards..... 3-2
 - Driver distraction 3-2
 - Control your speed 3-3
 - Keep your vehicle in safe condition..... 3-3
- Seats 3-4
 - Safety precautions 3-7
 - Front seats 3-8
 - Rear seats 3-16
 - Headrest 3-18
 - Seat warmers 3-22
 - Air ventilation seats 3-26
- Seat belts..... 3-28
 - Seat belt safety precautions 3-28
 - Seat belt warning light..... 3-29
 - Seat belt restraint system..... 3-31
 - Additional seat belt safety precautions..... 3-36
 - Care of seat belts 3-38
- Child Restraint System (CRS) 3-39
 - Our recommendation: Children at middle position 3-39
 - Selecting a Child Restraint System (CRS) 3-40
 - Installing a Child Restraint System (CRS) 3-42
- Airbag - supplemental restraint system..... 3-52
 - Where are the airbags?..... 3-54
 - How does the airbags system operate? 3-60
 - What to expect after an airbag inflates 3-65
 - Do not install a Child Restraint System on the front passenger seat..... 3-66
 - Why didn't my airbag go off in a collision? 3-67
 - SRS care..... 3-72
 - Additional safety precautions 3-72
 - Airbag warning labels 3-73

Important safety precautions

You will find many safety precautions and recommendations throughout this section, and throughout this manual. The safety precautions in this section are among the most important.

Always wear your seat belt

A seat belt is your best protection in all types of accidents. Airbags are designed to supplement seat belts, not to replace them. So even though your vehicle is equipped with airbags, ALWAYS make sure you and your passengers wear your seat belts, and wear them properly.

Restrain all children

All children under age 13 should ride in your vehicle properly restrained in a rear seat, not the front seat. Infants and small children should be restrained in an appropriate Child Restraint System. Larger children should use a booster seat with the lap/shoulder belt until they can use the seat belt properly without a booster seat.

Airbag hazards

While airbags can save lives, they can also cause serious or fatal injuries to occupants who sit too close to them, or who are not properly restrained. Infants, young children, and short adults are at the greatest risk of being injured by an inflating airbag. Follow all instructions and warnings in this manual.

Driver distraction

Driver distraction presents a serious and potentially deadly danger, especially for inexperienced drivers. Safety should be the first concern when behind the wheel and drivers need to be aware of the wide array of potential distractions, such as drowsiness, reaching for objects, eating, personal grooming, other passengers, and using mobile phones.

Drivers can become distracted when they take their eyes and attention off the road or their hands off the wheel to focus on activities other than driving. To reduce your risk of distraction and an accident:

- Set up your mobile devices (for example, MP3 players, phones, navigation units, etc.) ONLY when your vehicle is parked or safely stopped.
- ONLY use your mobile device when allowed by laws and conditions permit safe use. NEVER text or email while driving. Most countries have laws prohibiting drivers from texting. Some countries and cities also prohibit drivers from using handheld phones.
- NEVER let the use of a mobile device distract you from driving. You have a responsibility to your passengers and others on the road to always drive safely, with your hands on the wheel as well as your eyes and attention on the road.

Control your speed

Excessive speed is a major factor in crash injuries and deaths. Generally, the higher the speed, the greater the risk, but serious injuries can also occur at lower speeds. Never drive faster than is safe for current conditions, regardless of the maximum speed posted.

Keep your vehicle in safe condition

Having a tire blowout or a mechanical failure can be extremely hazardous. To reduce the possibility of such problems, check your tire pressures and condition frequently, and perform all regularly scheduled maintenance.

Seats



The actual shape may differ from the illustration.

Front seat

- (1) Seat sliding forward or rearward/Cushion height/Seat cushion (Relaxation comfort) angle
- (2) Seatback angle
- (3) Lumbar support
- (4) Relaxation comfort seat switch
- (5) Walk-in switch
- (6) Seat warmer/Air ventilation seat
- (7) Headrest

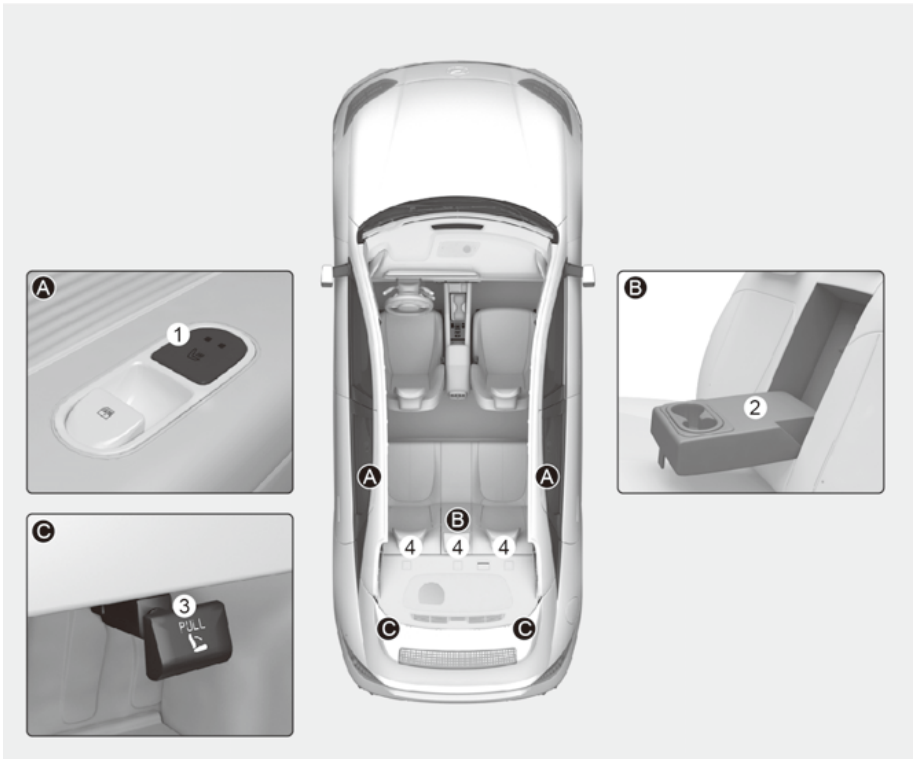

The actual shape may differ from the illustration.

Rear seat

- (1) Seat warmer
- (2) Armrest
- (3) Seatback folding lever
- (4) Headrest

Infotainment system

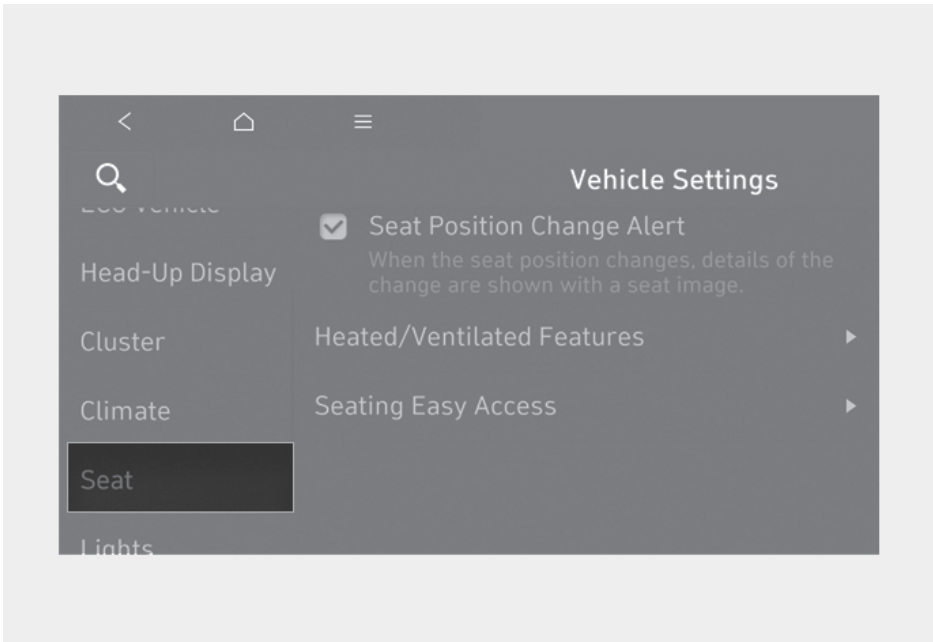

Select **Setup > Vehicle Settings > Seat** from the Settings menu in the infotainment system, you may use various convenience functions.

- Seat position change alert: When the seat position changes, details of the change are shown with a seat image.
- Heated/Ventilated features
 - Auto. Controls That Use Climate Control Settings (for driver's seat): The seat temperature is automatically controlled.
- Seating easy access
 - Driver seat easy access: The distance (Normal/Extended/Off) the seat automatically moves when the driver enters or leaves the vehicle may be selected.

i Information

The infotainment system may change after software updates. For more information, refer to the manual provided in the infotainment system and the quick reference guide.

i Information

The information provided may differ depending on which functions are applicable to your vehicle.

Safety precautions

Adjusting the seats so that you are sitting in a safe and comfortable position plays an important role for the safety of the driver and passengers, as much as seat belts and airbags when in an accident.

WARNING

Do not use a cushion that reduces friction between the seat and the passenger. The passenger's hips may slide under the lap portion of the seat belt during an accident or a sudden stop.

Serious or fatal internal injuries could result because the seat belt cannot operate properly.

Airbags

You can take steps to reduce the risk of being injured by an inflating airbag. Sitting too close to an airbag greatly increases the risk of injury in the event the airbag inflates. Move your seat as far back as possible from front airbags, while still maintaining control of the vehicle.

WARNING

To reduce the risk of serious injury or death from an inflating airbag, take the following precautions:

- Adjust the driver's seat as far to the rear as possible while maintaining the ability to control the vehicle.
 - Adjust the front passenger seat as far to the rear as possible.
 - Hold the steering wheel by the rim with your hands at the 9 o'clock and 3 o'clock positions to minimize the risk of injuries to your hands and arms.
 - NEVER place anything or anyone between you and the airbag.
 - Do not allow the front passenger to place feet or legs on the dashboard to minimize the risk of leg injuries.
-

Seat belts

Always fasten your seat belt before starting any trip. At all times, passengers should sit upright and be properly restrained. Infants and small children must be restrained in appropriate Child Restraint Systems. Children who have outgrown a booster seat and adults must be restrained using the seat belts.

WARNING

Take the following precautions when adjusting your seat belt:

- NEVER use one seat belt for more than one occupant.
 - Always position the seatback upright with the lap portion of the seat belt snug and low across the hips.
 - NEVER allow children or small infants to ride on a passenger's lap.
 - Do not route the seat belt across your neck, across sharp edges, or reroute the shoulder strap away from your body.
 - Do not allow the seat belt to become caught or jammed.
-

Front seats

WARNING

Take the following precautions when adjusting your seat:

- NEVER attempt to adjust the seat while the vehicle is moving. The seat could respond with unexpected movement and may cause loss of vehicle control resulting in an accident.
 - Do not place anything under the front seats. Loose objects in the driver's foot area could interfere with the operation of the foot pedals, causing an accident.
 - Do not allow anything to interfere with the normal position and proper locking of the seatback.
 - Do not place a cigarette lighter on the floor or seat. When you operate the seat, gas may exit out of the lighter causing a fire.
 - Use extreme caution when picking up small objects trapped under the seats or between the seat and the center console. Your hands might be cut or injured by the sharp edges of the seat mechanism.
 - If there are occupants in the rear seats, be careful while adjusting the front seat position.
 - Make sure that the seat is locked in place after the adjustment. If not, the seat might move unexpectedly resulting in an accident.
-

⚠ CAUTION

To prevent injury:

- Do not adjust your seat while wearing your seat belt. Moving the seat cushion forward may cause strong pressure on your abdomen.
- Do not allow your hands or fingers to get caught in the seat mechanisms while the seat is moving.

⚠ WARNING

NEVER allow children in the vehicle unattended. The power seats are operable when the vehicle is turned off.

NOTICE

To prevent damage to the seats:

- Always stop adjusting the seats when the seat has been adjusted as far forward or rearward as possible.
- Do not adjust the seats longer than necessary when the vehicle is turned off. This may result in unnecessary battery drain.
- Do not operate two or more seats at the same time. This may result in an electrical malfunction.

Manual adjustment

+ if equipped

The front seat can be adjusted by using the levers located underneath the seat cushion. Before driving, adjust the seat to the proper position so that you can easily control the steering wheel, foot pedals and controls on the instrument panel.

Forward and rearward adjustment

To move the seat forward or rearward:

1. Pull up the seat slide adjustment lever and hold it.
2. Slide the seat to the position you desire.
3. Release the lever and make sure the seat is locked in place. Move forward and rearward without using the lever. If the seat moves, it is not locked properly.

Seatback angle



To recline the seatback:

1. Lean forward slightly and lift up the seatback lever.
2. Carefully lean back on the seat and adjust the seatback to the position you desire.
3. Release the lever and make sure the seatback is locked in place. (The lever MUST return to its original position for the seatback to lock.)

Reclining seatback

Sitting in a reclined position when the vehicle is in motion can be dangerous. Even when buckled up, the protections of your restraint system (seat belts and/or airbags) is greatly reduced by reclining your seatback.

WARNING

NEVER ride with a reclined seatback when the vehicle is moving.

Riding with a reclined seatback increases your chance of serious or fatal injuries in the event of a collision or sudden stop.

Drivers and passengers should **ALWAYS** sit well back in their seats, properly belted, and with the seatbacks upright.

Seat belts must be snug against your hips and chest to work properly. When the seatback is reclined, the shoulder belt cannot do its job because it will not be snug against your chest. Instead, it will be in front of you. During an accident, you could be thrown into the seat belt, causing neck or other injuries.

The more the seatback is reclined, the greater chance the passenger's hips will slide under the lap belt or the passenger's neck will strike the shoulder belt.

Seat height

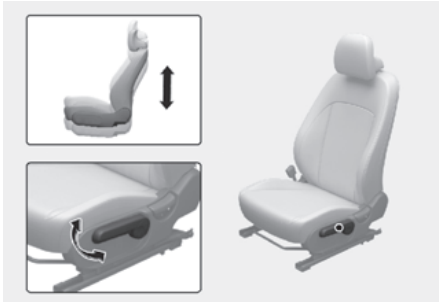

To change the height of the seat cushion:

- Push down the lever several times, to lower the seat cushion.
- Pull up the lever several times, to raise the seat cushion.

Power adjustment

+ if equipped

The front seat can be adjusted by using the control switches located on the outside of the seat cushion. Before driving, adjust the seat to the proper position so that you can easily control the steering wheel, foot pedals and controls on the instrument panel.

Forward and rearward adjustment

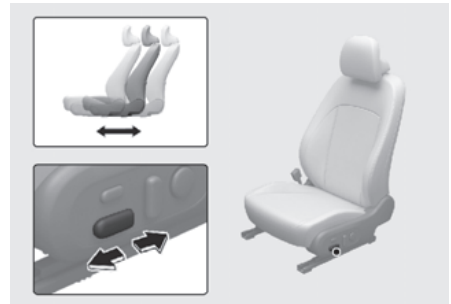

To move the seat forward or rearward:

1. Push the control switch forward or rearward.
2. Release the switch once the seat reaches the desired position.

Seat cushion tilt/height adjustment



- Seat cushion tilt (1)

To change the angle of the front part of the seat cushion:

Push the front portion of the control switch up to raise or down to lower the front part of the seat cushion.

Release the switch once the seat reaches the desired position.

- Seat height (2)

To change the height of the seat cushion:

Push the rear portion of the control switch up to raise or down to lower the height of the seat cushion.

Release the switch once the seat reaches the desired position.

Seatback angle adjustment



To recline the seatback:

1. Push the control switch forward or rearward.
2. Release the switch once the seatback reaches the desired position.

Reclining seatback

Sitting in a reclined position when the vehicle is in motion can be dangerous. Even when buckled up, the protections of your restraint system (seat belts and airbags) is greatly reduced by reclining your seatback.

⚠ WARNING

NEVER ride with a reclined seatback when the vehicle is moving.

Riding with a reclined seatback increases your chance of serious or fatal injuries in the event of a collision or sudden stop.

Driver and passengers should ALWAYS sit well back in their seats, properly belted, and with the seatbacks upright.

Seat belts must be snug against your hips and chest to work properly. When the seatback is reclined, the shoulder belt cannot do its job because it will not be snug against your chest. Instead, it will be in front of you. During an accident, you could be thrown into the seat belt, causing neck or other injuries.

The more the seatback is reclined, the greater chance the passenger's hips will slide under the lap belt or the passenger's neck will strike the shoulder belt.

Lumbar support

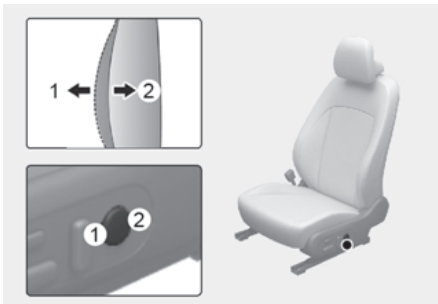

To adjust the lumbar support:

- Press the front portion of the switch (1) to increase support or the rear portion of the switch (2) to decrease support.

NOTICE

Do not continue to operate the lumbar support when the lumbar support provides its maximum support. Damage to the lumbar support motor could occur.

Relaxation comfort seat (for Driver's seat, passenger's seat, if equipped)



Relaxation comfort seats distribute body pressure and concentrated weight on specific body parts that occur while sitting in the same position for a long period of time. The seat relieves fatigue and discomfort by providing the optimal sit position.

NOTICE

Press auto return button to restore the seat position after operating the Relaxation comfort seat.

Any seat adjustment other than the auto return may restrict the downward cushion movement.

CAUTION

Take the following precautions when using the relaxation comfort seat:

- Do not use the relaxation comfort seat while the vehicle is moving. Using the comfort seat could increase the risk of injuries in the event of a collision or sudden stop.
- Do not use the relaxation comfort seat when the luggage or other objects are placed at the rear seat.
- Do not use the relaxation comfort seat while the vehicle is moving. Seat belts may not operate normally due to the lack of adherence between the shoulder belts and the body.
- Do not use the relaxation comfort seat when the rear seats are not in the rearmost position and upright.

Passenger relaxation comfort seat switch



Driver/passenger relaxation comfort seat switch



To activate relaxation comfort seat

Press the switch (1), an alarm appears on the infotainment screen. Then, press the switch (1) again.

If the switch is not pressed within 5 seconds after the alarm appears, relaxation comfort seat will not be activated.

When relaxation comfort seat is activated:

- The seat cushion will be moved forward or rearward automatically.
- The seat cushion, seatback angle and leg support will be adjusted.

In the following cases, an alarm appears on when the infotainment screen is on and the relaxation comfort seat will be deactivated.

- When the gear is not in P (Parking). (only for driver's seat)
- When the vehicle is moving more than 3 km/h (1.8 mph). (only for driver's seat)
- When the rear seat belt is fastened

i Information

When relaxation comfort seat cannot be operated, try to reset Integrated Memory System. If relaxation comfort seat does not operate even after Integrated Memory System is reset, it is recommended that you contact an authorized HYUNDAI dealer.

- To deactivate relaxation comfort seat
If you press the front portion of the switch (2) while the seat is in the relaxation comfort seat position, the seat return backs to the original position.

When relaxation comfort seat is deactivated:

- The driver seat will return to the position which the gear was in P (Park).
- Passenger seat will return to the original position.

In the following cases, the relaxation comfort seat will not return to the original position for the driver' seat.

- When the gear is not in P (Parking).
- When the vehicle is moving more than 3 km/h(1.8 mph).

i Information

When relaxation comfort seat cannot be operated, try to reset Integrated Memory System. If relaxation comfort seat does not operate even after Integrated Memory System is reset, it is recommended that you contact an authorized HYUNDAI dealer.

NOTICE

Do not use the seat switches simultaneously. It may damage the seat system.

Seatback pocket

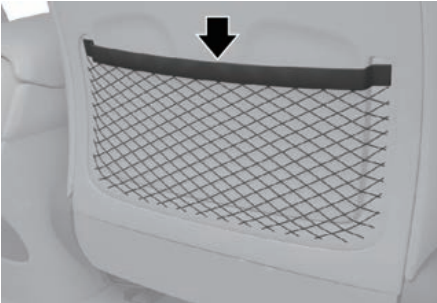

The seatback pocket is provided on the back of the front seatbacks.

CAUTION

Do not put heavy or sharp objects in the seatback pockets. In an accident they could come loose from the pocket and injure occupants.

Walk-in switch

 If equipped



The rear seat passenger may use the switches to control the front passenger seat.

- Sliding forward or rearward:
Press the switch (1) or (2) to move the front passenger seat forward or rearward.

- Seatback angle:
Press the switch (3) or (4) to recline the front passenger seatback forward or rearward.

Rear seats

Folding the rear seats

The rear seatbacks can be folded to facilitate carrying long items or to increase the luggage capacity of the vehicle.

WARNING

- Never allow passengers to sit on top of the folded down seatback while the vehicle is moving. This is not a proper seating position and no seat belts are available for use. This could result in serious injury or death in case of an accident or sudden stop.
- Objects carried on the folded down seatback should not extend higher than the top of the front seatbacks. This could allow cargo to slide forward and cause injury or damage during sudden stops.

To fold down the rear seatback:

1. Set the front seatback to the upright position and if necessary, slide the front seat forward.

2. Lower the rear headrests to the lowest position.

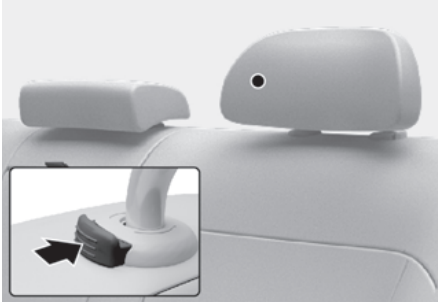

3. Route the seat belt webbing to the outward of the rear seat to prevent the belts from being trapped behind or under the seats.



4. Fold the seatback toward the front of the vehicle.



5. To use the rear seat, lift and pull the seatback rearward. Pull the seatback firmly until it clicks in to place. Make sure the seatback is locked in place.

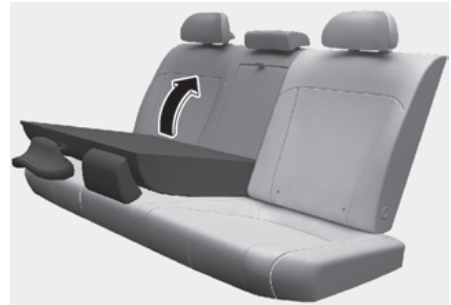

WARNING

- When returning the rear seatback from a folded to an upright position, hold the seatback and return it slowly. Ensure that the seatback is completely locked into its upright position by pushing on the top of the seatback. In an accident or sudden stop, the unlocked seatback could allow cargo to move forward with great force and enter the passenger compartment, which could result in serious injury or death.

⚠ WARNING

- Do not place objects in the rear seats, since they cannot be properly secured and may hit vehicle occupants in a collision causing serious injury or death.
-

Armrest



The armrest is located in the center of the rear seat. Pull the armrest down from the seatback to use it.

⚠ CAUTION

The armrest handle may be pressed when folding the rear seatback, but it will be restored after a certain period of time.

Headrest

The vehicle's front and rear seats have adjustable headrests. The headrests provide comfort for passengers, but more importantly they are designed to help protect passengers from whiplash and other neck and spinal injuries during an accident, especially in a rear impact collision.

⚠ WARNING

To reduce the risk of serious injury or death in an accident, take the following precautions when adjusting your headrests:

- Always properly adjust the headrests for all passengers BEFORE starting the vehicle.
- NEVER let anyone ride in a seat with the headrest removed or reversed.
- Adjust the headrests so the middle of the headrest is at the same height as the height of the top of the eyes.

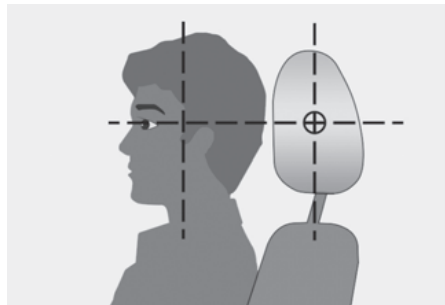

- NEVER adjust the headrest position of the driver's seat when the vehicle is in motion.
 - Adjust the headrest as close to the passenger's head as possible. Do not use a seat cushion that holds the body away from the seatback.
 - Make sure the headrest locks into position after adjusting it.
-

⚠ WARNING

When sitting on the rear seat, do not adjust the height of the headrest to the lowest position.

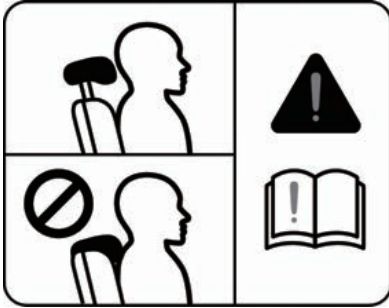
**⚠ CAUTION**

- When there is no occupant in the rear seats, adjust the height of the headrest to the lowest position. The rear seat headrest can reduce the visibility of the rear area.
- To prevent damage, NEVER hit or pull on the headrests.

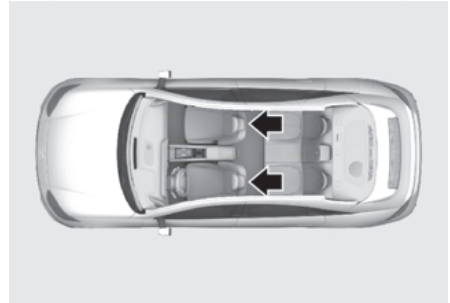
Front seat headrests

The driver's and front passenger's seats are equipped with adjustable headrests for the passengers safety and comfort.

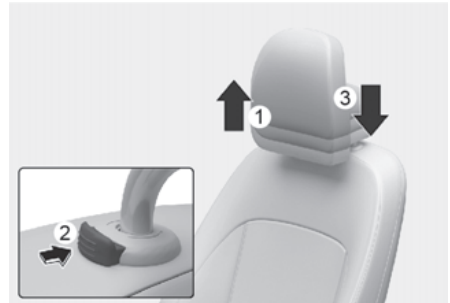
Adjusting the height up and down

To raise the headrest:

1. Pull it up to the desired position (1).

To lower the headrest:

1. Push and hold the release button (2) on the headrest support.
2. Lower the headrest to the desired position (3).

Forward and rearward adjustment



The headrest may be adjusted forward by pulling the headrest forward to the desired detent. To adjust the headrest to its furthest rearwards position, pull it fully forward to the farthest position and release it.

NOTICE



If you recline the seatback towards the front with the headrest and seat cushion raised, the headrest may come in contact with the sunvisor or other parts of the vehicle.

Removal/Reinstall

To remove the headrest:

Manual adjustment seat

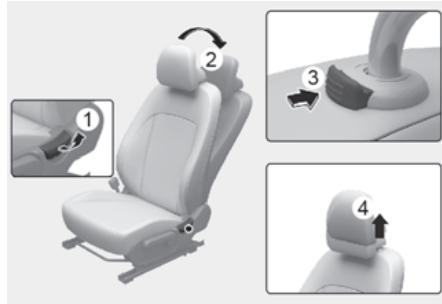

Power adjustment seat

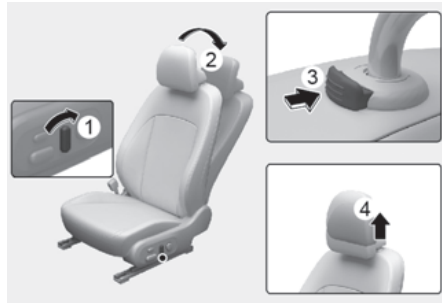

1. Recline the seatback (2) with the seatback angle switch (1).
2. Pull up the headrest to the upmost position and press the release button (3) to remove the headrest (4).

WARNING

NEVER allow anyone to travel in a seat with the headrest removed.

To reinstall the headrest:

Manual adjustment seat

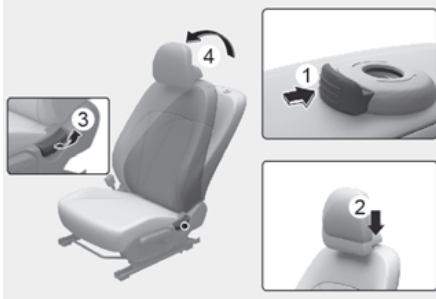

Power adjustment seat

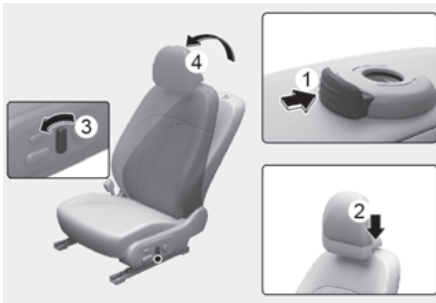

1. Recline the seat back by pressing seatback angle lever or switch (3).
2. Put the headrest poles (2) into the holes while pressing the release button (1).
3. Adjust the headrest to the appropriate height.
4. Adjust the seatback angle (4) with the seatback angle switch (3).

WARNING

Always make sure the headrest locks into position after reinstalling and adjusting it properly.

Rear seat headrests

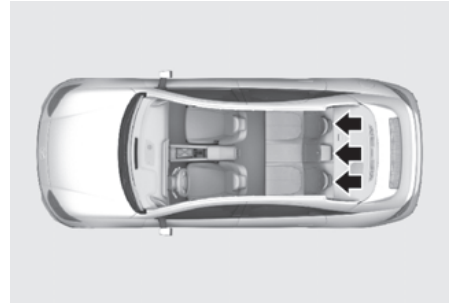

The rear seats are equipped with headrests in all the seating positions for the passenger's safety and comfort.

Adjusting the height up and down

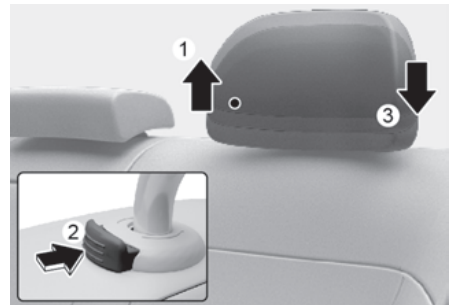

To raise the headrest:

1. Pull it up to the desired position (1).

To lower the headrest:

1. Push and hold the release button (2) on the headrest support.
2. Lower the headrest to the desired position (3).

Removal/Reinstallation

To remove the headrest:

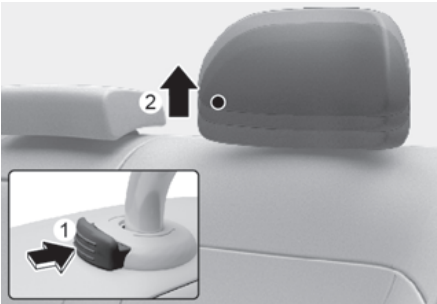

1. Raise the headrest as far as it can go.
2. Press the headrest release button (1) while pulling the headrest up (2).

To reinstall the headrest:



1. Put the headrest poles into the holes (3) while pressing the release button (1).
2. Adjust the headrest to the appropriate height.

Seat warmers

Seat warmers are provided to warm the seats during cold weather.

During mild weather or under conditions where the operation of the seat warmer is not needed, keep the seat warmers OFF.

! WARNING

The seat warmers can cause a **SERIOUS BURN**, even at low temperatures and especially if used for long periods of time.

Passengers must be able to feel if the seat is becoming too warm so they can turn it off, if needed.

Seat warmers consumes huge amount of electricity. Please avoid using seat warmers while the vehicle is off in order to prevent the battery discharge.

People who cannot detect temperature change or pain to the skin should use extreme caution, especially the following types of passengers:

- Infants, children, elderly or disabled persons, or hospital outpatients.
- People with sensitive skin or who burn easily.
- Fatigued individuals.
- Intoxicated individuals.
- People taking medication that can cause drowsiness or sleepiness.

⚠ WARNING

NEVER place anything on the seat that insulates against heat when the seat warmer is in operation, such as a blanket or seat cushion. This may cause the seat warmer to overheat, causing a burn or damage to the seat.

NOTICE

To prevent damage to the seat warmers and seats:

- Never use a solvent such as paint thinner, benzene, alcohol or gasoline to clean the seats.
- Do not place heavy or sharp objects on seats equipped with seat warmers.
- Do not change the seat cover. It may damage the seat warmer.

Front seat warmers

+ if equipped

Infotainment system

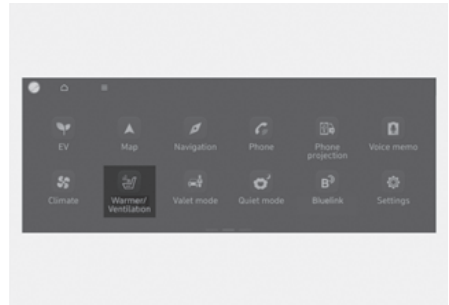

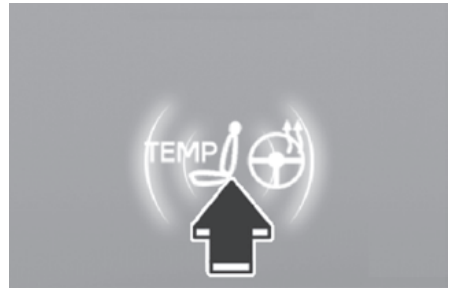

While the vehicle is running, touch Heating/Ventilation icon in the infotainment home screen.

Climate control panel



Press **TEMP** in the front climate control panel.



To activate seat warmer of each front seats, touch  icon on the infotainment screen. Adjust the temperature by pressing either  or  icons.

The seat warmer will automatically stop when the seat temperature reaches certain level and will automatically reactivate when the seat temperature drops below certain temperature.

- Manual temperature control
Refer to the infotainment system web manual for manual temperature control.
- Automatic temperature control
The seat warmer starts to automatically control the seat temperature in order to prevent low temperature burns after being manually turned on.



You may manually touch the icon to increase seat temperature. However, the seat temperature is automatically adjusted again.

- Auto. Controls That Use Climate Control Settings (for driver's seat)

The seat warmer automatically controls the seat temperature depending on the ambient temperature when the vehicle is running.

To use this function, it must be enabled from the Settings menu in the infotainment screen. Select:

- **Setup > Vehicle Settings > Seat > Heated/Ventilated Features > Auto. Controls That Use Climate Control Settings > Seat Warmer/Ventilation**
- The seat warmer defaults to the OFF position whenever the Start/Stop button is pressed to the ON position. However, if the Auto. Controls That Use Climate Control Settings function is On, the driver's seat warmer will turn on and off depending on the ambient temperature.

Information

The infotainment system may change after software updates. For more information, refer to the manual provided in the infotainment system and the quick reference guide.

Rear seat warmers

⁺if equipped



- While the vehicle is running, press seat warmer switches located in each seats to warm the rear seat.
- The seat warmer will automatically stop when the seat temperature reaches certain level and will automatically reactivate when the seat temperature drops below certain temperature.
- Manual temperature control
Each time you press the switch, the temperature setting of the seat is changed as follows:



- Automatic temperature control

The seat warmer starts to automatically control the seat temperature in order to prevent low temperature burns after being manually turned on.





You may manually push the switch to increase seat temperature. However, the seat temperature is automatically adjusted again.

- The seat warmer defaults to the OFF position whenever the Start/Stop button is pressed to the ON position.
- The rear seat warmers can be adjusted from the infotainment screen.



- Touch rear heat icon in the Heating/Ventilation infotainment screen.



To activate seat warmer of each rear seats, touch  icon on the infotainment screen. Adjust the temperature by pressing either  or  icons.

Information

The infotainment system may change after software updates. For more information, refer to the manual provided in the infotainment system and the quick reference guide.

Air ventilation seats

The air ventilation seats are provided to cool the front seats by blowing air through small vent holes on the surface of the seat cushions and seatbacks.

When the operation of the air ventilation seat is not needed, keep the air ventilation seats OFF.

NOTICE

To prevent damage to the air ventilation seats:

- Never use a solvent such as paint thinner, benzene, alcohol or gasoline to clean the seats.
- Avoid spilling liquids on the surface of the front seats and seatbacks; this may cause the air vent holes to block and not work properly.
- Do not place materials such as plastic bags or newspapers under the seats. They may block the air intake causing malfunction of the air vent.
- Do not change the seat covers. It may damage the air ventilation seat.
- If the air vents do not operate, restart the vehicle. If there is no change, we recommend your vehicle to be inspected by an authorized HYUNDAI dealer.

Front air ventilation seats

+ if equipped

Infotainment system

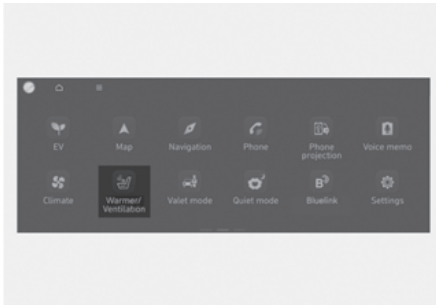



While the vehicle is running, touch Heating/Ventilation icon in the infotainment home screen.

Climate control panel



Press **TEMP** in the front climate control panel.



To activate air ventilation of each front seats, touch  icon on the infotainment system. Adjust the airflow by pressing either  or  icons.

- If the air ventilation seat is positioned at HIGH, the airflow speed will increase according to vehicle speed.
- Use the air ventilation seat with the air conditioning on for more effective ventilation.
- It may take 3-5 minutes after switch operation to feel the temperature change.

Refer to the infotainment system web manual for manual temperature control.

- Auto. Controls That Use Climate Control Settings (for driver's seat)

The air ventilation seat automatically controls the seat temperature depending on the ambient temperature when the vehicle is running.

To use this function, it must be enabled from the Settings menu in the infotainment system. Select:

- **Setup > Vehicle Settings > Seat > Heated/Ventilated Features > Auto. Controls That Use Climate Control Settings > Seat Warmer/Ventilation**
- The air ventilation seats defaults to the OFF position whenever the Start/Stop button is pressed to the ON position. However, if the Auto. Controls That Use Climate Control Settings function is on, the driver's air ventilation will turn on and off depending on the ambient temperature.

Information

The infotainment system may change after software updates. For more information, refer to the manual provided in the infotainment system and the quick reference guide.

Seat belts

This section describes how to use the seat belts properly. It also describes some of the things not to do when using seat belts.

Seat belt safety precautions

Always fasten your seat belt and make sure all passengers have fastened their seat belts before starting any trip. Airbags are designed to supplement the seat belt as an additional safety device, not a replacement. Most countries require all occupants of a vehicle to wear seat belts.

WARNING

Seat belts must be used by ALL passengers whenever the vehicle is moving. Take the following precautions when adjusting and wearing seat belts:

- Children under the age of 13 should be properly restrained in the rear seats.
- Never allow children to ride in the front passenger seat, unless the airbag is deactivated. If a child is seated in the front passenger seat, move the seat as far back as possible. And the child must always be restrained in the seat properly.
- NEVER allow an infant or child to be carried on an occupant's lap.
- NEVER ride with the seatback reclined when the vehicle is moving.
- Do not allow children to share a seat or seat belt.
- Do not wear the shoulder belt under your arm or behind your back.

- NEVER wear a seat belt over fragile objects. If there is a sudden stop or impact, the seat belt can damage it.
- Do not use the seat belt if it is twisted. A twisted seat belt will not protect you properly in an accident.
- Do not use a seat belt if the webbing or hardware is damaged.
- Do not latch the seat belt into the buckles of other seats.
- NEVER unfasten the seat belt while driving. This may cause loss of vehicle control resulting in an accident.
- Make sure there is nothing in the buckle interfering with the seat belt latch mechanism, because any materials in the buckle can cause the seat belt not to be fastened securely.
- No modifications or additions should be made by the user which will either prohibit the seat belt adjusting devices from operating to remove slack, or prohibit the seat belt assembly from being adjusted to remove slack.

WARNING

Damaged seat belts and seat belt assemblies will not operate properly. Always replace:

- Frayed, contaminated, or damaged webbing.
- Damaged hardware.
- The entire seat belt assembly after it has been worn in an accident, even if damage to webbing or assembly is not apparent.

Seat belt warning light

Driver's seat belt warning

Instrument cluster



As a reminder to the driver, the driver's seat belt warning lights will illuminate for about 6 seconds each time the Start/Stop button is in the ON position regardless of belt fastening. If the seatbelt is not fastened, the warning chime will sound for about 6 seconds.

If you start to drive without the seat belt fastened or you unfasten the seat belt when you drive under 20 km/h (12 mph) or stop, the corresponding warning light will illuminate.

If you start to drive without the seat belt fastened or you unfasten the seat belt when you drive 20 km/h (12 mph) and faster, the warning light will blink and warning chime will sound for about 100 seconds.

When the seat belt is unfastened during driving, the warning light will illuminate when the speed is under 20 km/h (12 mph).

When the speed is 20 km/h (12 mph) and faster, the warning light will blink and warning chime will sound for about 100 seconds.

Front passenger's seat belt warning

As a reminder to the front passenger, the front passenger's seat belt warning lights will illuminate for about 6 seconds each time the Start/Stop button is turned on regardless of belt fastening.

If you start to drive without the seat belt fastened or you unfasten the seat belt when you drive under 20 km/h (12 mph) or stop, the corresponding warning light will illuminate.

If you start to drive without the seat belt fastened or you unfasten the seat belt when you drive 20 km/h (12 mph) and faster, the warning light will blink and warning chime will sound for about 100 seconds.

When the seat belt is unfastened during driving, the warning light will illuminate when the speed is under 20 km/h (12 mph). When the speed is 20 km/h (12 mph) and faster, the warning light will blink and warning chime will sound for about 100 seconds.

WARNING

Riding in an improper position adversely affects the front passenger's seat belt warning system. It is important for the driver to instruct the passenger to properly be seated as instructed in this manual.

Information

- Although the front passenger seat is not occupied, the seat belt warning light will blink or illuminate for 6 seconds.
- The front passenger's seat belt warning may operate when luggage is placed on the front passenger seat.

Rear passenger's seat belt warning

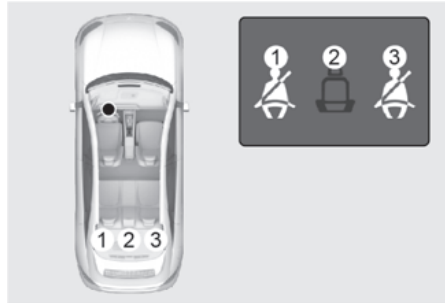

For rear left and right side seat

- As a reminder to the rear passenger, the rear passenger's seat belt warning lights will illuminate for about 6 seconds each time the Start/Stop button is in the ON position regardless of belt fastening.
- If you start to drive without the seat belt fastened or you unfasten the seat belt when you drive under 20 km/h (12 mph), the corresponding warning light will continue to illuminate until you fasten the seat belt.
- If you continue to drive without the seat belt fastened or you unfasten the seat belt when you drive 20 km/h (12 mph) and faster, the seat belt warning chime will sound for about 35 seconds and the corresponding warning light will blink.
- When the seat belt is unfastened during driving, the warning lights will illuminate when the speed is under 20 km/h (12 mph).
- When the speed is 20 km/h (12 mph) and faster, the warning light will blink and warning chime will sound for about 35 seconds.

For rear center seat

- As a reminder to the rear passenger, the rear passenger's seat belt warning lights will illuminate for about 6 seconds each time the Start/Stop button is in the ON position regardless of belt fastening.
- If the seat belt is not fastened when the Start/Stop button is turned on, the seat belt warning light will illuminate for about 70 seconds.
- If you start to drive without the seat belt fastened or you unfasten the seat belt when you drive under 20 km/h (12 mph), the corresponding warning light will continue to illuminate for about 70 seconds.
- If you continue to drive without the seat belt fastened or you unfasten the seat belt when you drive over 20 km/h (12 mph), the seat belt warning chime will sound for about 35 seconds and the corresponding warning light will blink.
- If the rear door is opened or closed under 10 km/h (6 mph), warning light and warning sound does not work even if driving over 20 km/h (12 mph).

Seat belt restraint system

Lap/shoulder belt

To fasten your seat belt:

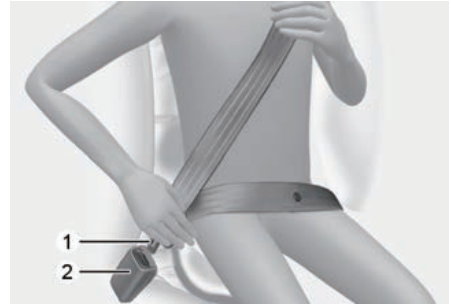

Pull it out of the retractor and insert the metal tab (1) into the buckle (2). There will be an audible "click" when the tab locks into the buckle.



You should place the lap belt (1) portion across your hips and the shoulder belt (2) portion across your chest.

The seat belt automatically adjusts to the proper length after the lap belt portion is adjusted manually so that it fits snugly around your hips. If you lean forward in a slow, easy motion, the belt will extend and move with you.

If there is a sudden stop or impact, the belt will lock into position. It will also lock if you try to lean forward too quickly.

NOTICE

If you are not able to smoothly pull enough of the seat belt out from the retractor, firmly pull the seat belt out and release it. After release, you will be able to pull the belt out smoothly.

⚠ WARNING



Improperly positioned seat belts may increase the risk of serious injury in an accident. Take the following precautions when adjusting the seat belt:

- Position the lap portion of the seat belt as low as possible across your hips, not on your waist, so that it fits snugly. This allows your strong pelvic bones to absorb the force of the crash, reducing the chance of internal injuries.

- Position one arm under the shoulder belt and the other over the belt, as shown in the illustration.
- Always position the shoulder belt anchor into the locked position at the appropriate height.
- Never position the shoulder belt across your neck or face.

Height adjustment

You can adjust the height of the shoulder belt anchor to one of the four different positions for maximum comfort and safety.

The shoulder portion should be adjusted so it lies across your chest and midway over your shoulder nearest the door, not over your neck.

Front seat

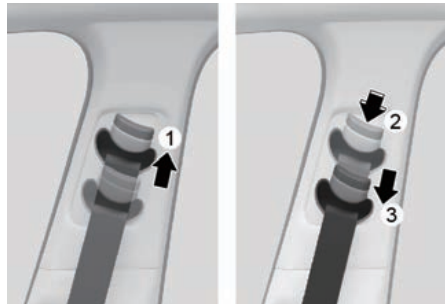

To adjust the height of the seat belt anchor, lower or raise the height adjuster into an appropriate position.

To raise the height adjuster, pull it up (1). To lower it, push it down (3) while pressing the height adjuster button (2).

Release the button to lock the anchor into position. Try sliding the height adjuster to make sure that it has locked into position.

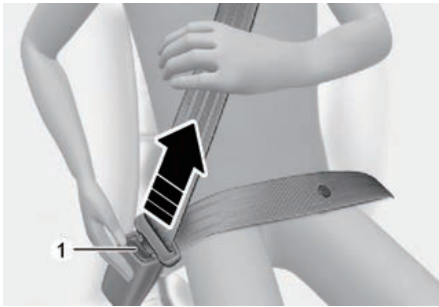

To release your seat belt:

Press the release button (1) in the locking buckle.

Once released, the belt should automatically draw back into the retractor. If this does not happen, check the belt to be sure it is not twisted, then try again.

Rear center seatbelt (3-point rear center seat belt)



When using the rear center seat belt, the buckle with the "CENTER" mark must be used.

***i* Information**

If you are not able to pull out the safety belt from the retractor, firmly pull the belt out and release it. After release, you will be able to pull the belt out smoothly.

 WARNING

Make sure that the seatback is locked in place when using the rear center seat belt.

If not, the seatback may move when there is a sudden stop or collision, which could result in serious injury.

Pre-tensioner seat belt

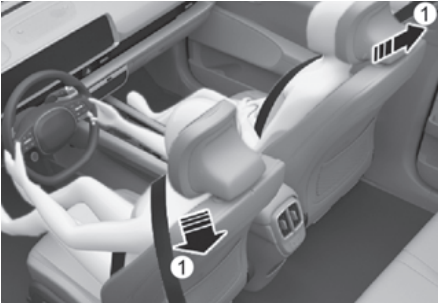

(1) Retractor pre-tensioner seat belt

Your vehicle is equipped with driver's and front passenger's and rear passengers Pre-tensioner Seat Belts (Retractor pre-tensioner). The purpose of the pre-tensioner is to make sure the seat belts fit tightly against the occupant's body in certain frontal or side collision(s). The pre-tensioner seat belts may be activated in crashes where the frontal or side collision(s) is severe enough, together with the airbags.

When the vehicle stops suddenly, or if the occupant tries to lean forward too quickly, the seat belt retractor will lock into position.

In certain frontal collisions, the pre-tensioner will activate and pull the seat belt into tighter contact against the occupant's body.

If the system senses excessive tension on the driver or passenger's seat belt when the pre-tensioner system activates, the load limiter inside the retractor pre-tensioner will release some of the pressure on the affected seat belt.

WARNING

- Always wear your seat belt and sit properly in your seat.
- Do not use the seat belt if it is loose or twisted. A loose or twisted seat belt will not protect you properly in an accident.
- Do not place anything near the buckle. This may adversely affect the buckle and cause it to function improperly.
- Always replace your pre-tensioners after activation or an accident.
- NEVER inspect, service, repair or replace the pre-tensioners by yourself. We recommend that you have the pre-tensioners inspected, serviced, repaired or replaced by an authorized HYUNDAI dealer.
- Do not hit the seat belt assemblies.

WARNING

Do not touch the pre-tensioner seat belt assemblies for several minutes after they have been activated. When the pre-tensioner seat belt mechanism deploys during a collision, the pre-tensioner can become hot and can burn you.

⚠ CAUTION

Body work on the front area of the vehicle may damage the pre-tensioner seat belt system. Therefore, we recommend the system to be serviced by an authorized HYUNDAI dealer.

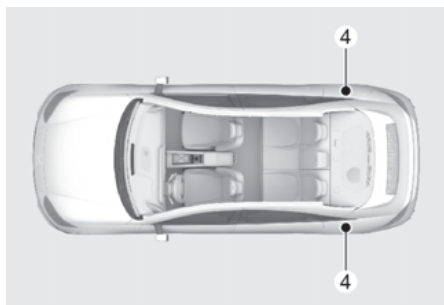
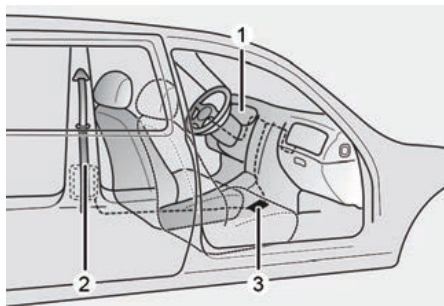

The pre-tensioner seat belt system consists mainly of the following components. Their locations are shown in the illustration above:

- (1) SRS airbag warning light
- (2) Retractor pre-tensioner
- (3) SRS control module
- (4) Rear retractor pre-tensioner

NOTICE

The sensor that activates the SRS control module is connected with the pre-tensioner seat belts. The SRS airbag warning light on the instrument cluster will illuminate for about 3-6 seconds after the Start/Stop button is in the ON position, and then it should turn off.

If the pre-tensioner is not working properly, the warning light will illuminate even if the SRS airbag is not malfunctioning. If the warning light does not illuminate, stays illuminated or illuminates when the vehicle is being driven, we recommend the pre-tensioner seat belts and/or SRS control module be inspected by an authorized HYUNDAI dealer as soon as possible.

i Information

- Pre-tensioner seat belts may be activated in certain frontal or side collisions or rollover situations.
 - When the pre-tensioner seat belts are activated, a loud noise may be heard and fine dust, which may appear to be smoke, may be visible in the passenger compartment. These are normal operating conditions and are not hazardous.
 - Although it is non-toxic, the fine dust may cause skin irritation and should not be inhaled for prolonged periods. Wash all exposed skin areas thoroughly after an accident in which the pre-tensioner seat belts were activated.
-

Additional seat belt safety precautions

Seat belt use during pregnancy

The seat belt should always be used during pregnancy. The best way to protect your unborn child is to protect yourself by always wearing the seat belt.

Pregnant women should always wear a lap-shoulder seat belt. Place the shoulder belt across your chest, routed between your breasts and away from your neck. Place the lap belt below your belly so that it fits **SNUGLY** across your hips and pelvic bone, under the rounded part of the belly.

! WARNING

To reduce the risk of serious injury or death to an unborn child during an accident, pregnant women should **NEVER** place the lap portion of the seat belt above or over the area of the abdomen where the unborn child is located.

Seat belt use and children

Infant and small children

Most countries have Child Restraint System laws which require children to travel in approved Child Restraint System devices, including booster seats. The age at which seat belts can be used instead of Child Restraint System differs among countries, so you should be aware of the specific requirements in your country, and where you are travelling. Infant and Child Restraint System must be properly placed and installed in a rear seat.

For more information refer to the "Child Restraint System (CRS)" section in this chapter.

! WARNING

ALWAYS properly restrain infants and small children in a Child Restraint System appropriate for the child's height and weight.

To reduce the risk of serious injury or death to a child and other passengers, **NEVER** hold a child in your lap or arms when the vehicle is moving. The violent forces created during an accident will tear the child from your arms and throw the child against the interior of the vehicle.

Small children are best protected from injury in an accident when properly restrained in the rear seat by a Child Restraint System that meets the requirements of the Safety Standards of your country. Before buying any Child Restraint System, make sure that it has a label certifying that it meets Safety Standard of your country.

The Child Restraint System must be appropriate for your child's height and weight. Check the label on the Child Restraint System for this information. Refer to the "Child Restraint System (CRS)" section in this chapter.

Larger children

Children under age 13 and who are too large for a booster seat should always occupy the rear seat and use the available lap/shoulder belts. A seat belt should lie across the upper thighs and be snug across the shoulder and chest to restrain the child safely. Check belt fit periodically. A child's squirming could put the belt out of position. In the event of an accident, children are afforded the best safety restrained by a proper Child Restraint System in the rear seats.

If a larger child over age 13 must be seated in the front seat, the child must be securely restrained by the available lap/shoulder belt and the seat should be placed in the rearmost position.

If the shoulder belt portion slightly touches the child's neck or face, try placing the child closer to the center of the vehicle. If the shoulder belt still touches their face or neck, they need to be returned to an appropriate booster seat in the rear seat.

WARNING

- Always make sure larger children's seat belts are worn and properly adjusted.
- NEVER allow the shoulder belt to contact the child's neck or face.
- Do not allow more than one child to use a single seat belt.

Seat belt use and injured people

A seat belt should be used when an injured person is being transported. Consult a physician for specific recommendations.

One person per belt

Two people (including children) should never attempt to use a single seat belt. This could increase the severity of injuries in case of an accident.

Do not lie down

Sitting in a reclined position when the vehicle is in motion can be dangerous. Even when buckled up, the protections of your restraint system (seat belts and/or airbags) is greatly reduced by reclining your seatback.

Seat belts must be snug against your hips and chest to work properly.

During an accident, you could be thrown into the seat belt, causing neck or other injuries.

The more the seat back is reclined, the greater the chance for the passenger's hips to slide under the lap belt or the passenger's neck to strike the shoulder belt.



WARNING

- NEVER ride with a reclined seatback when the vehicle is moving.
 - Riding with a reclined seatback increases your chance of serious or fatal injuries in the event of a collision or sudden stop.
 - Driver and passengers should always sit well back in their seats with the seatbacks upright and should be belted properly.
-

Care of seat belts

Seat belt systems should never be disassembled or modified. In addition, care should be taken to assure that seat belts and belt hardware are not damaged by seat hinges, doors or other abuse.

Periodic inspection

All seat belts should be inspected periodically for wear or damage of any kind. Any damaged parts should be replaced as soon as possible.

Keep belts clean and dry

Seat belts should be kept clean and dry. If belts become dirty, they can be cleaned by using a mild soap solution and warm water. Bleach, dye, strong detergents or abrasives should not be used because they may damage and weaken the fabric.

When to replace seat belts

The entire seat belt assembly or assemblies should be replaced if the vehicle has been involved in an accident. This should be done even if no damage is visible. We recommend that you consult an authorized HYUNDAI dealer.

Child Restraint System (CRS)

Our recommendation: Children at middle position

WARNING

Always properly restrain children in the vehicle. Children of all ages are safer when riding in the rear seats. Never place a rearward-facing Child Restraint System on the front passenger seat, unless the airbag is deactivated.

Children under age 13 should always ride in the rear seats and must always be properly restrained to minimize the risk of injury in an accident, sudden stop or sudden maneuver.

According to accident statistics, children are safer when properly restrained in the rear seats than in the front seat. Children too large for a Child Restraint System must use the seat belts provided.

Most countries have regulations which require children to travel in approved Child Restraint Systems.

The laws governing the age or height/weight restrictions at which seat belts can be used instead of Child Restraint System differs among countries, so you should be aware of the specific requirements in your country, and where you are travelling.

Child Restraint Systems must be properly installed in the vehicle seat. Always use a commercially available Child Restraint System that meets the requirements of your country.

Child Restraint System (CRS)

Infants and younger children must be restrained in an appropriate rearward-facing or forward-facing CRS that has first been properly secured to the seat of the vehicle. Read and comply with the instructions for installation and use provided by the manufacturer of the Child Restraint System.

WARNING

- Always follow the Child Restraint System manufacturer's instructions for installation and use.
- Always properly restrain your child in the Child Restraint System.
- Do not use an infant carrier or a child safety seat that "hooks" over a seatback, it may not provide adequate protection in an accident.
- After an accident, we recommend an authorized HYUNDAI dealer to check the Child Restraint System, seat belts, ISOFIX anchorages and top-tether anchorages.

Selecting a Child Restraint System (CRS)

When selecting a Child Restraint System for your child, always:

- Make sure the Child Restraint System has a label certifying that it meets applicable Safety Standards of your country.

A Child Restraint System may only be installed if it was approved in accordance with the requirements of ECE-R44 or ECE-R129.

- Select a Child Restraint System based on your child's height and weight. The required label or the instructions for use typically provide this information.
- Select a Child Restraint System that fits the vehicle seating position where it will be used.
- Read and comply with the warnings and instructions for installation and use provided with the Child Restraint System.

Child Restraint System types

There are three main types of Child Restraint Systems: rearward-facing, forward-facing and booster Child Restraint Systems.

They are classified according to the child's age, height and weight.

Rearward-facing Child Restraint System



A rearward-facing Child Restraint System provides restraint with the seating surface against the back of the child. The harness system holds the child in place, and in an accident, acts to keep the child positioned in the Child Restraint Systems and reduce the stress to the fragile neck and spinal cord.

All children under the age of one year must always ride in a rearward-facing Child Restraint System. There are different types of rearward-facing Child Restraint Systems: infant-only Child Restraint Systems can only be used rearward-facing. Convertible and 3-in-1 Child Restraint Systems typically have higher height and weight limits for the rearward-facing position, allowing you to keep your child rearward-facing for a longer period of time.

Keep using Child Restraint Systems in the rearward-facing position as long as children fit within the height and weight limits allowed by the Child Restraint System's manufacturer.

Forward-facing Child Restraint System



A forward-facing Child Restraint System provides restraint for the child's body with a harness. Keep children in a forward-facing Child Restraint System with a harness until they reach the top height or weight limit allowed by your Child Restraint System's manufacturer. Once your child outgrows the forward-facing Child Restraint System, your child is ready for a booster seat.

Booster seats

A booster seat is a Child Restraint System designed to improve the fit of the vehicle's seat belt system. A booster seat positions the seat belt so that it fits properly over the stronger parts of your child's body. Keep your children in booster seats until they are big enough to fit in a seat belt properly.

For a seat belt to fit properly, the lap belt must lie comfortable across the upper thighs, not the stomach. The shoulder belt should lie comfortable across the shoulder and chest and not across the neck or face. Children under age 13 must always be properly restrained to minimize the risk of injury in an accident, sudden stop or sudden maneuver.

Installing a Child Restraint System (CRS)

WARNING

Before installing your Child Restraint System always:

Read and follow the instructions provided by the manufacturer of the Child Restraint System.

Failure to follow all warnings and instructions could increase the risk of the SERIOUS INJURY or DEATH if an accident occurs.

WARNING

If the vehicle headrest prevents proper installation of a Child Restraint System, the headrest of the respective seating position shall be readjusted or entirely removed.

After selecting a proper Child Restraint System for your child and checking that the Child Restraint System fits properly on the seating position, there are three general steps for a proper installation:

- **Properly secure the Child Restraint System to the vehicle.** All Child Restraint Systems must be secured to the vehicle with the lap belt or lap part of a lap/shoulder belt or with the ISOFIX top-tether and/or ISOFIX anchorage and/or with the support leg.
- **Make sure the Child Restraint System is firmly secured.** After installing a Child Restraint System to the vehicle, push and pull the seat forward and from side-to-side to verify that it is securely attached to the seat. A Child Restraint System secured with a seat belt should be installed as firmly as possible. However, some side-to-side movement can be expected. When installing a Child Restraint System, adjust the vehicle seat and seatback (up and down, forward and rearward) so that your child fits in the Child Restraint System in a comfortable manner.
- **Secure the child in the Child Restraint System.** Make sure the child is properly strapped in the Child Restraint System according to the Child Restraint System manufacturer's instructions.

CAUTION

A Child Restraint System in a closed vehicle can become very hot. To prevent burns, check the seating surface and buckles before placing your child in the Child Restraint System.

Suitability of each seating position for belted & ISOFIX Child Restraint Systems according to UN regulations (for Europe)

(Information for vehicle users and CRS manufacturers)

- Yes: Suitable for fitment of the designated category of CRS
- No: Not suitable for fitment of the designated category of CRS
- '-': Not applicable
- The table is based on left-hand drive vehicle. Except for the front passenger seat, the table is valid for right-hand drive vehicle. For right-hand drive vehicle front passenger seat, please use information for the seating position number 3.

CRS categories		Seating positions					
		1,2	3		4	5	6
			Airbag ON	Airbag OFF			
Universal belted CRS	All mass groups	-	No	Yes* F, R	Yes F, R	Yes F, R	Yes F, R
i-size CRS	ISOFIX CRF: F2, F2X, R1, R2	-	No	No	Yes F, R	No	Yes F, R
Carry-cot (ISOFIX lateral facing CRS)	ISOFIX CRF: L1, L2	-	No	No	No	No	No
ISOFIX infant* CRS (*: ISOFIX baby CRS)	ISOFIX CRF: R1	-	No	No	Yes R	No	Yes R
ISOFIX toddler CRS - small	ISOFIX CRF: F2,F2X, R2,R2X	-	No	No	Yes F, R	No	Yes F, R
ISOFIX toddler CRS - large* (*: not booster seats)	ISOFIX CRF: F3,R3	-	No	No	Yes F, R	No	Yes F, R
Booster Seat - reduced Width	ISO CRF: B2	-	No	No	Yes	No	Yes
Booster Seat-full Width	ISO CRF: B3	-	No	No	Yes	No	Yes

***i* Information**

F: Forward facing, R: Rearward facing

*: To install Universal CRS, 1st row passenger seat height should be at its mid position.

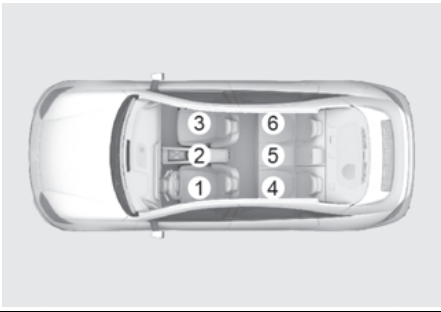
Seat number	Position in the vehicle	Seating positions
1	Front left	
2	Front center	
3	Front right	
4	2nd row left	
5	2nd row center	
6	2nd row right	

***i* Information**

- If the vehicle headrest prevents proper installation of a CRS, the headrest of the seating position shall be readjusted or entirely removed.
 - Never place a rearward facing Child Restraint System on the front passenger seat, unless the airbag is deactivated.
-

Recommended Child Restraint Systems (for Europe)

Child Height or Mass Group	CRS Manufacturer	CRS Model name	Type of Fixation	ECE Approval Number
40-83 cm	Britax Römer	BABY-SAFE 3 i-SIZE and Flex Base i-Sense	ISOFIX with support leg (rearward facing)	E1*129R03/04*0060
76-105 cm	Britax Römer	Trifix 2 i-size	ISOFIX and toptether	E1*129R02/06*0015
Group II	Britax Römer	KidFix 2 R	ISOFIX and vehicle belt, using CRS lap belt guide	R44/04-E1-04301304
Group III	Graco	Booster Basic	Vehicle belt	R44/04-E11-0444165

CRS Manufacturer information

Britax: www.britax.com

Graco: www.gracobaby.eu

Suitability of each seating position for belted & ISOFIX Child Restraint Systems according to UN regulations (except Europe)

(Information for vehicle users and CRS manufacturers)

- Yes: Suitable for fitment of the designated category of CRS
- No: Not suitable for fitment of the designated category of CRS
- "-": Not applicable
- The table is based on left-hand drive vehicle. Except for the front passenger seat, the table is valid for right-hand drive vehicle. For right-hand drive vehicle front passenger seat, please use information for the seating position number 3.

CRS categories		Seating positions					
		1,2	3		4	5	6
			Airbag ON	Airbag OFF			
Universal belted CRS	All mass groups	-	No	Yes* F	Yes F, R	Yes F, R	Yes F, R
i-size CRS	ISOFIX CRF: F2, F2X, R1, R2	-	No	No	No	No	No
Carry-cot (ISOFIX lateral facing CRS)	ISOFIX CRF: L1, L2	-	No	No	No	No	No
ISOFIX infant* CRS (*: ISOFIX baby CRS)	ISOFIX CRF: R1	-	No	No	Yes R	No	Yes R
ISOFIX toddler CRS - small	ISOFIX CRF: F2,F2X, R2,R2X	-	No	No	Yes F, R	No	Yes F, R
ISOFIX toddler CRS - large* (*: not booster seats)	ISOFIX CRF: F3,R3	-	No	No	Yes F, R	No	Yes F, R
Booster Seat - reduced Width	ISO CRF: B2	-	No	No	Yes	No	Yes
Booster Seat -full Width	ISO CRF: B3	-	No	No	Yes	No	Yes

i Information

- F: Forward facing, R: Rearward facing
- *: To install Universal CRS, 1st row passenger seat height should be at its mid position.

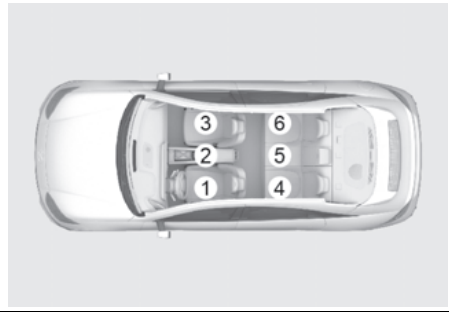
Seat number	Position in the vehicle	Seating positions
1	Front left	
2	Front center	
3	Front right	
4	2nd row left	
5	2nd row center	
6	2nd row right	

i Information

- If the vehicle headrest prevents proper installation of a CRS, the headrest of the seating position shall be readjusted or entirely removed.
- Never place a rearward facing Child Restraint System on the front passenger seat, unless the airbag is deactivated.

ISOFIX anchorage and top-tether anchorage (ISOFIX anchorage system) for children

The ISOFIX system holds a Child Restraint System during driving and in an accident. This system is designed to make installation of the Child Restraint System easier and reduce the possibility of improperly installing your Child Restraint System. The ISOFIX system uses anchors in the vehicle and attachments on the Child Restraint System. The ISOFIX system eliminates the need to use seat belts to secure the Child Restraint System to the rear seats.

ISOFIX anchorages are metal bars built into the vehicle. There are two lower anchors for each ISOFIX seating position that will accommodate a Child Restraint System with lower attachments.

To use the ISOFIX system in your vehicle, you must have a Child Restraint System with ISOFIX attachments.

The Child Restraint System manufacturer will provide you with instructions on how to use the Child Restraint System with its attachments for the ISOFIX anchorages.

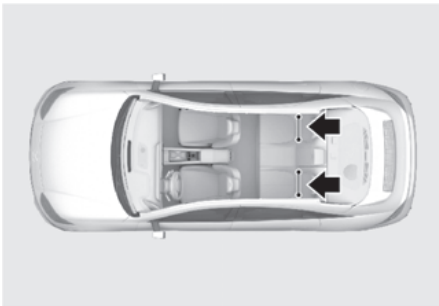

ISOFIX anchorages have been provided in the left and right outboard rear seating positions. Their locations are shown in the illustration.

⚠ WARNING

Do not attempt to install a Child Restraint System using ISOFIX anchorages in the rear center seating position. There are no ISOFIX anchorages provided for this seat. Using the outboard seat anchorages, for the CRS installation on the rear center seating position, can damage the anchorages.



[A] ISOFIX Anchorage Position Indicator

(Type A- , Type B- )

[B] ISOFIX Anchorage

ISOFIX anchorages are located between the seatback and the seat cushion of the rear seat left and right outboard seating positions, indicated by the symbols.

Securing a Child Restraint System with the "ISOFIX Anchorage System"

To install an i-Size or ISOFIX-compatible Child Restraint System in either of the rear outboard seating positions:

1. Move the seat belt buckle away from the ISOFIX anchorages.
2. Move any other objects away from the anchorages that could prevent a secure connection between the Child Restraint System and the ISOFIX anchorages.
3. Place the Child Restraint System on the vehicle seat, then attach the seat to the ISOFIX anchorages according to the instructions provided by the Child Restraint System manufacturer.
4. Follow the instructions of the Child Restraint System's manufacturer for proper installation and connection of the ISOFIX attachments on the Child Restraint System to the ISOFIX anchorages.

WARNING

Take the following precautions when using the ISOFIX system:

- Read and follow all installation instructions provided with your Child Restraint System.
 - To prevent the child from reaching and taking hold of unretracted seat belts, buckle all unused rear seat belts and retract the seat belt webbing behind the child. Children can be strangled if a shoulder belt becomes wrapped around their neck and the seat belt tightens.
 - NEVER attach more than one Child Restraint System to a single anchorage. This could cause the anchor or attachment to come loose or break.
 - Always have the ISOFIX system inspected by your dealer after an accident. An accident can damage the ISOFIX system and may not properly secure the Child Restraint System.
-

Securing a Child Restraint System seat with "Top-tether Anchorage" system

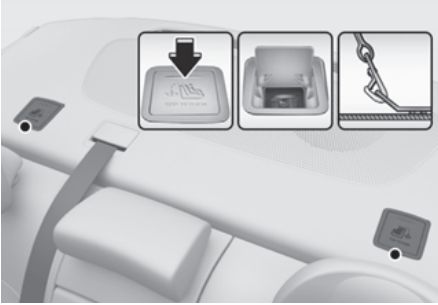

Top-tether anchorages for Child Restraint Systems are located on the rear of the seatbacks.



1. Route the Child Restraint System top-tether strap over the seatback. Placing the top tether strap, follow the instructions of the Child Restraint System manufacturer.

2. Connect the top-tether strap to the top-tether anchorage, then tighten the top-tether strap according to the instructions of your Child Restraint System's manufacturer to firmly attach the Child Restraint System to the seat.

WARNING

Take the following precautions when installing the top-tether:

- Read and follow all installation instructions provided with your Child Restraint System.
- NEVER attach more than one Child Restraint System to a single ISOFIX top-tether anchorage. This could cause the anchorage or attachment to come loose or break.
- Do not attach the top-tether to anything other than the correct top-tether anchorage. It may not work properly if attached to something else.
- Child Restraint System anchorages are designed to withstand only those loads imposed by correctly fitted Child Restraint System.

Do not use them for adult seat belts, harnesses, or for attaching other items or equipment to the vehicle.

Securing a Child Restraint System with a lap/shoulder belt

When not using the ISOFIX system, all Child Restraint Systems must be secured to a rear seat with the lap part of a lap/shoulder belt.



Installing a Child Restraint System with a lap/shoulder belt

To install a Child Restraint System on the rear seats, do the following:

1. Place the Child Restraint System on a rear seat and route the lap/shoulder belt around or through the Child Restraint System, following the Child Restraint System manufacturer's instructions. Make sure the seat belt webbing is not twisted.



2. Fasten the lap/shoulder belt latch into the buckle. Listen for the distinct "click" sound.

i Information

Position the release button so that it is easy to access in case of an emergency.



3. Remove as much slack from the belt as possible by pushing down on the Child Restraint System while feeding the shoulder belt back into the retractor.
4. Push and pull on the Child Restraint System to confirm that the seat belt is holding it firmly in place.

If your Child Restraint System manufacturer recommends the use of a top-tether with the lap/shoulder belt, see "Installing a Child Restraint System (CRS)".

To remove the Child Restraint System, press the release button on the buckle and then pull the lap/shoulder belt out of the Child Restraint System and allow the seat belt to retract fully.

! WARNING

If a child restraint is installed in the second row center seat, move the second row seat far back as possible, to minimize contact with the front center side airbag (if equipped with front center side airbag).

Airbag - supplemental restraint system

Left-hand drive

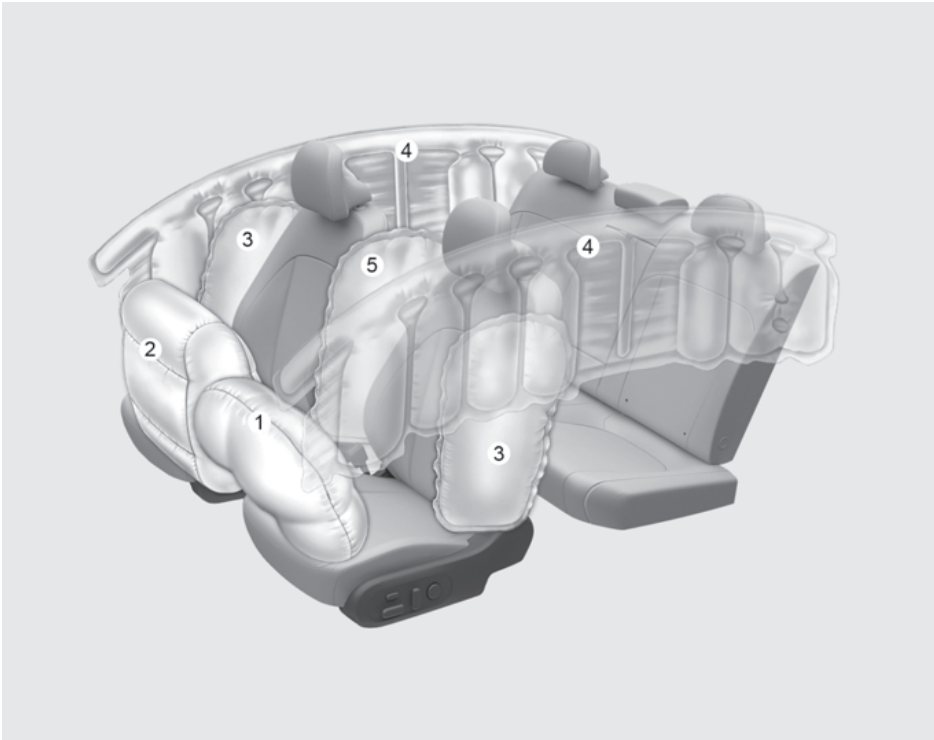

The actual airbags in the vehicle may differ from the illustration.

- (1) Driver's front airbag
- (2) Passenger's front airbag
- (3) Side airbag
- (4) Curtain airbag
- (5) Front center side airbag

Right-hand drive

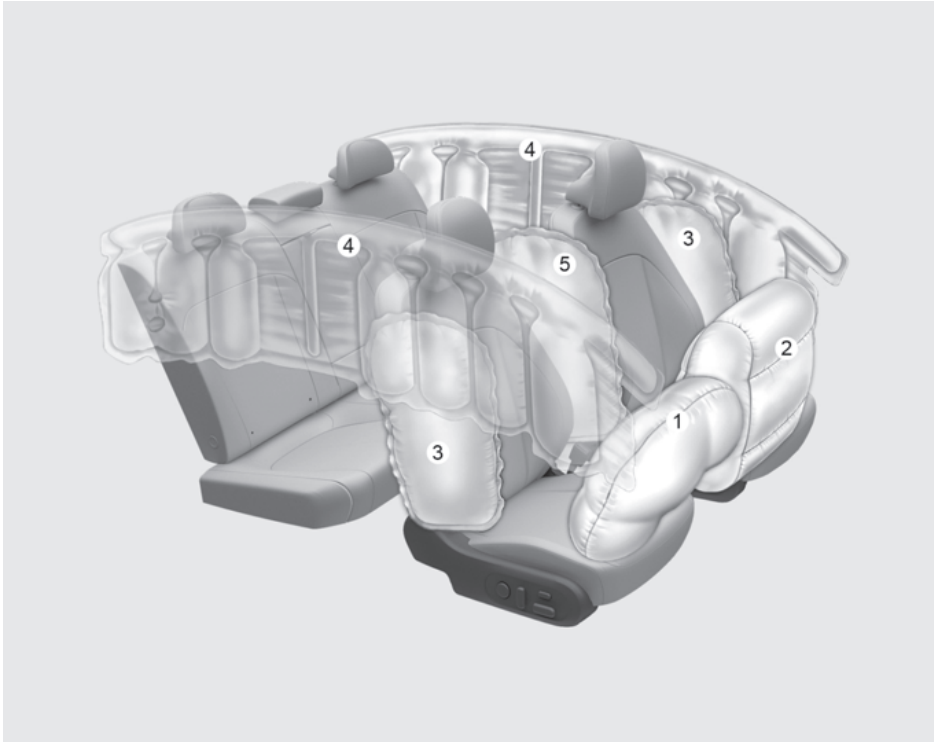

The actual airbags in the vehicle may differ from the illustration.

- (1) Driver's front airbag
- (2) Passenger's front airbag
- (3) Side airbag
- (4) Curtain airbag
- (5) Front center side airbag

The vehicles are equipped with a Supplemental AIRBAG System for the driver's seat and front passenger's seats.

The front airbags are designed to supplement the three-point seat belts. For these airbags to provide protection, the seat belts must be worn at all times when driving. You can be severely injured or killed in an accident if you are not wearing a seat belt. Airbags are designed to supplement seat belts, but do not replace them. Also, airbags are not designed to deploy in every collision. In some accidents, the seat belts are the only restraint protecting you.

WARNING

AIRBAG SAFETY PRECAUTIONS

ALWAYS use seat belts and Child Restraint Systems - every trip, every time, everyone! Even with airbags, you can be seriously injured or killed in a collision if you are improperly belted or not wearing your seat belt when the airbag inflates.

NEVER place a child in any Child Restraint System or booster seat in the front passenger seat, unless the airbag is deactivated.

An inflating airbag could forcefully strike the infant or child causing serious or fatal injuries.

ABC - Always Buckle Children under age 13 in the back seat. It is the safest place for children of any age to ride. If a child age 13 or older must be seated in the front seat, he or she must be properly belted and the seat should be moved as far back as possible.

All occupants should sit upright with the seatback in an upright position, centered on the seat cushion with their seat belt on, legs comfortably extended and their feet on the floor until the vehicle is parked and the vehicle is turned off. If an occupant is out of position during an accident, the rapidly deploying airbag may forcefully contact the occupant causing serious or fatal injuries.

You and your passengers should never sit or lean unnecessarily close to the airbags or lean against the door or center console.

Move your seat as far back as possible from front airbags, while still maintaining control of the vehicle.

Where are the airbags?

Driver's and passenger's front airbags

Driver's front airbag



Passenger's front airbag

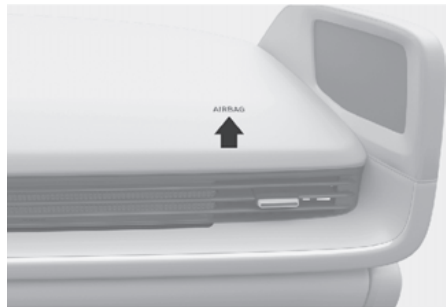

Your vehicle is equipped with a Supplemental Restraint System (SRS) and lap/shoulder belts at both the driver and passenger seating positions.

The SRS consists of airbags which are located in the center of the steering wheel and the passenger's side front panel pad above the glove box.

The airbags are labeled with the letters "AIRBAG" embossed on the pad covers.

The purpose of the SRS is to provide the vehicle's driver and front passengers with additional protection than that offered by the seat belt system alone in case of a frontal impact of sufficient severity.

WARNING

To reduce the risk of serious injury or death from inflating front airbags, take the following precautions:

- Seat belts must be worn at all times to help keep occupants positioned properly.
- Move your seat as far back as possible from front airbags, while still maintaining control of the vehicle.
- Never lean against the door or center console.
- Do not allow the front passenger to place their feet or legs on the dashboard.
- No objects (such as crash pad cover, mobile phone holder, cup holder, perfume or stickers) should be placed over or near the airbag modules on the steering wheel, instrument panel, windshield glass, and the front passenger's panel above the glove box. Such objects could cause harm if the vehicle is in a crash severe enough to cause the airbags to deploy.
- Do not attach any objects on the front windshield and inside mirror.

Passenger's front airbag ON/OFF settings

 if equipped

You can deactivate the passenger's front airbag from the infotainment system if a child restraint is installed on the front passenger's seat or if the front passenger's seat is unoccupied by a person. For detailed information, refer to the separately supplied infotainment system manual.

Operation

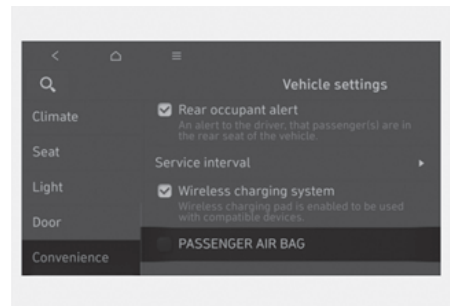
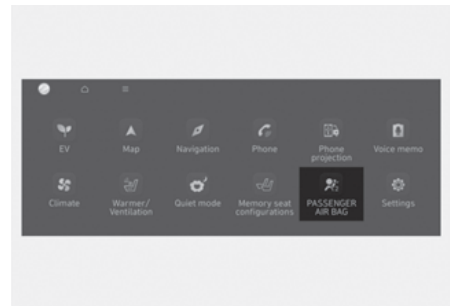

With the vehicle on, touch **Settings** > **PASSENGER AIRBAG** or **Settings** > **Vehicle settings** > **Convenience** > **PASSENGER AIRBAG** on the infotainment system.

NOTICE

To ensure the safety of your child, the passenger's front airbag must be deactivated when it should be necessary to install a rearward facing child seat on the front passenger seat in exceptional circumstances.

i Information

The infotainment system may change after software updates. For more information, refer to the manual provided in the infotainment system.

The passenger's front airbag ON/OFF setting

 if equipped

The purpose of the setting is to disable the passenger's front airbag in order to transport occupants who are at increased risk for airbag-related injury due to age, size, or medical condition.

The passenger's front airbag ON/OFF setting

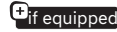
 if equipped

Operating conditions



- After the vehicle is running
 - The passenger's front airbag ON/OFF indicator appears for about 4 seconds.
- When the PASSENGER AIRBAG menu is selected or deselected
 - The passenger's front airbag ON/OFF indicator is appeared.

i Information

- The passenger's front airbag ON/OFF indicator generally illuminates for about 4 seconds after the Start/Stop button is in the ON position. But, if the Start/Stop button is pressed to the ON position within 3 minutes after the vehicle was turned off, the indicator will not illuminate.
- When the PASSENGER AIRBAG menu is selected, the passenger's front airbag is activated and child or infant seat should not be installed on the front passenger's seat.
- When the PASSENGER AIRBAG menu is deselected, the passenger's front airbag is deactivated.

⚠ WARNING

Never allow an adult passenger to ride in the front passenger seat when the passenger airbag OFF indicator is illuminated. During a collision, the airbag will not inflate if the indicator is illuminated. Turn on the passenger's front airbag or have your passenger move to the rear seat.

Side airbags and front center side airbag

+ if equipped

Driver's seat



Passenger's seat



Your vehicle is equipped with a side airbag in each front seat. The purpose of the airbag is to provide the vehicle's additional protection than that offered by the seat belt alone.

The side airbags are designed to deploy during certain side impact collisions, depending on the crash severity.

For vehicles equipped with a rollover sensor the side and/or curtain airbags and pre-tensioners on both sides of the vehicle may deploy if a rollover or possible rollover is detected.

The side airbags and front center side airbag are not designed to deploy in all side impact or rollover situations.

WARNING

To reduce the risk of serious injury or death from an inflating side airbag, take the following precautions:

- Seat belts must be worn at all times to help keep occupants positioned properly.
 - Do not allow passengers to lean their heads or bodies onto doors, put their arms on the doors, stretch their arms out of the window, or place objects between the doors and seats.
 - Hold the steering wheel at the 9 o'clock and 3 o'clock positions, to minimize the risk of injuries to your hands and arms.
 - Do not use any accessory seat covers. This could reduce or prevent the effectiveness of the system.
 - Do not hang other objects except clothes. In an accident it may cause vehicle damage or personal injury especially when airbag is inflated.
 - Do not place any objects over the airbag or between the airbag and yourself. Also, do not attach any objects around the area the airbag inflates such as the door, side door glass, front and rear pillar.
 - Do not place any objects between the door and the seat. They may become dangerous projectiles if the side airbag inflates.
 - Do not install any accessories on the side or near the side airbags.
 - Do not cause impact to the doors when the Start/Stop button is in the ON or START position as this may cause the side airbags to inflate.
 - If the seat or seat cover is damaged, we recommend that the system be serviced by an authorized HYUNDAI dealer.
-

Curtain airbags



Curtain airbags are located along both sides of the roof rails above the front and rear doors.

They are designed to help protect the heads of the front seat occupants and the rear outboard seat occupants in certain side impact collisions.

The curtain airbags are designed to deploy during certain side impact collisions, depending on the crash severity.

For vehicles equipped with a rollover sensor the side and/or curtain airbags and pre-tensioners on both sides of the vehicle may deploy if a rollover or possible rollover is detected.

The curtain airbags are not designed to deploy in all side impact or rollover situations.

WARNING

To reduce the risk of serious injury or death from an inflating curtain airbag, take the following precautions:

- All seat occupants must wear seat belts at all times to help keep occupants positioned properly.
- Properly secure Child Restraint System as far away from the door as possible.
- Do not place any objects over the airbag. Also, do not attach any objects around the area the airbag inflates such as the door, side door glass, front and rear pillar, roof side rail.
- Do not hang other objects except clothes, especially hard or breakable objects.

In an accident, it may cause vehicle damage or personal injury.

- Do not allow passengers to lean their heads or bodies onto doors, put their arms on the doors, stretch their arms out of the window, or place objects between the doors and seats.
- Do not attempt to open or repair the side curtain airbags yourself. If necessary, we recommend that the airbag be inspected by an authorized HYUNDAI dealer.

How does the airbags system operate?

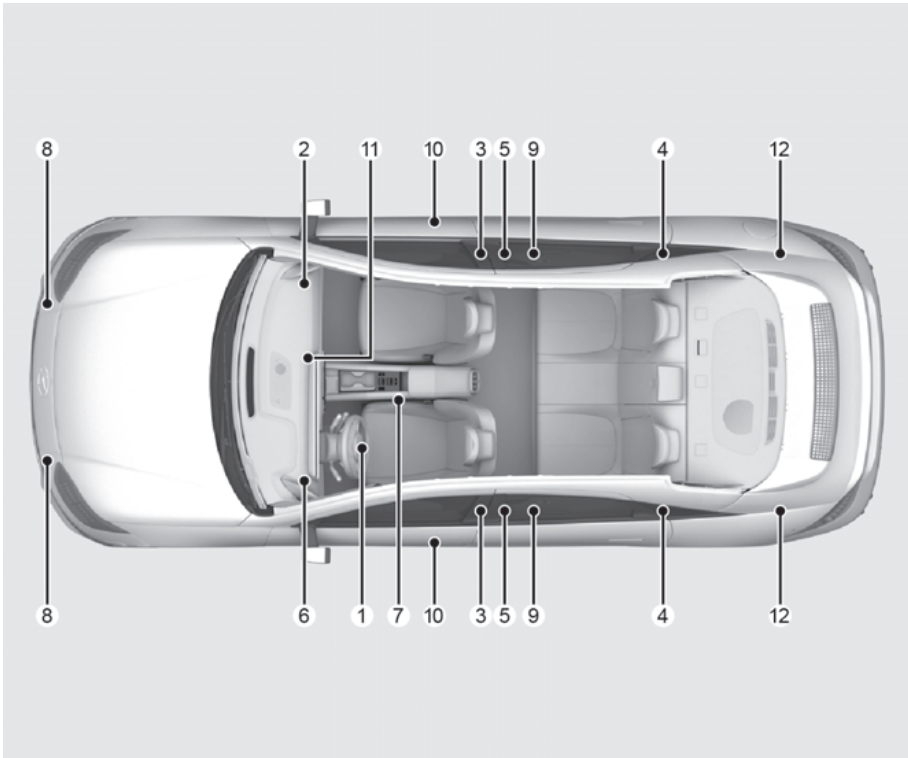

The SRS consists of the following components:

- (1) Driver's front airbag module
- (2) Passenger's front airbag module
- (3) Side airbag modules
- (4) Curtain airbag modules
- (5) Front retractor pre-tensioner
- (6) Airbag warning light

- (7) SRS control module (SRSCM) / Rollover sensor
- (8) Front impact sensors
- (9) Side impact sensors (acceleration)
- (10) Side impact sensors (pressure)
- (11) Front passenger's airbag ON/OFF Setting (if equipped)
- (12) Rear retractor pre-tensioner

i Information

Front passenger's airbag ON/OFF light is located on the overhead console.

The SRSCM (Supplemental Restraint System Control Module) continually monitors all SRS components while the Start/Stop button is ON to determine if a crash impact is severe enough to require airbag deployment or pre-tensioner seat belt deployment.

SRS warning light



The SRS (Supplemental Restraint System) airbag warning light on the instrument panel displays the airbag symbol depicted in the illustration. The system checks the airbag electrical system for malfunctions. The light indicates that there is a potential problem with your airbag system, which could include your side and/or curtain airbags used for rollover protection.

WARNING

If your SRS malfunctions, the airbag may not inflate properly during an accident increasing the risk of serious injury or death.

If any of the following conditions occur, your SRS is malfunctioning:

- The light does not turn on for about 3 to 6 seconds when the Start/Stop button is in the ON position.
- The light stays on after illuminating for about three to 6 seconds.
- The light comes on while the vehicle is in motion.
- The light blinks when the vehicle is running.

We recommend that an authorized HYUNDAI dealer inspect the SRS as soon as possible if any of these conditions occur.

During a moderate to severe frontal collision, sensors will detect the vehicle's rapid deceleration. If the rate of deceleration is high enough, the control unit will inflate the front airbags, at the time and with the force needed.

The front airbags help protect the driver and front passenger by responding to frontal impacts in which seat belts alone cannot provide adequate restraint. When needed, the side airbags help provide protection in the event of a side impact or rollover by supporting the side upper body area.

- Airbags are activated (able to inflate if necessary) only when the Start/Stop button is in the ON or START position, and it can be activated within about 3 minutes after the vehicle is turned off.
- Airbags inflate in the event of certain frontal or side collisions to help protect the occupants from serious physical injury.
- Generally, airbags are designed to inflate based upon the severity of a collision, its direction, or etc. These two factors determine whether the sensors produce an electronic deployment/inflation signal.
- The front airbags will completely inflate and deflate in an instant. It is virtually impossible for you to see the airbags inflate during an accident. It is much more likely that you will simply see the deflated airbags hanging out of their storage compartments after the collision.
- In addition to inflating in serious side collisions, vehicles equipped with a rollover sensor, side and/or curtain airbags and front center side airbag will inflate if the sensing system detects a rollover.

When a rollover is detected, curtain airbags will remain inflated longer to help provide protection from ejection, especially when used in conjunction with the seat belts.

However, the rapid airbag inflation can also cause injuries which can include facial abrasions, bruises and broken bones because the inflation speed also causes the airbags to expand with a great deal of force.
- To help provide protection, the airbags must inflate rapidly. The speed of airbag inflation is a consequence of extremely short time in which to inflate the airbag between the occupant and the vehicle structures before the occupant impacts those structures. This speed of inflation reduces the risk of serious or life-threatening injuries and is thus a necessary part of airbag design.
- There are even circumstances under which contact with the airbag can cause fatal injuries, especially if the occupant is positioned excessively close to the airbag.

You can take steps to reduce the risk of being injured by an inflating airbag. The greatest risk is sitting too close to the airbag. An airbag needs space to inflate. It is recommended that drivers sit as far as possible between the center of the steering wheel and the center of the chest while still maintaining control of the vehicle.

Driver's front airbag (1)



When the SRSCM detects a sufficiently severe impact to the front of the vehicle, it will automatically deploy the front airbags.

Driver's front airbag (2)



Upon deployment, tear seam molded directly into the pad cover will separate under pressure from the expansion of the airbags. Further opening of the covers allows full inflation of the airbags.

A fully inflated airbag, in combination with a properly worn seat belt, slows the driver's or the front passenger's forward motion, reducing the risk of head and chest injury.

Driver's front airbag (3)



Driver's front airbag (4)



After complete inflation, the airbag immediately starts deflating, enabling the driver to maintain forward visibility and the ability to steer or operate other controls.

WARNING

To prevent objects from becoming dangerous projectiles when the passenger's airbag inflates:

- Do not install or place any objects (drink holder, CD holder, stickers, etc.) on the front passenger's panel above the glove box where the passenger's airbag is located.
- Do not install a container of liquid air freshener near the instrument cluster or on the instrument panel surface.

What to expect after an airbag inflates

After a frontal or side airbag inflates, it will deflate very quickly. Airbag inflation will not prevent the driver from seeing out of the windshield or being able to steer. Curtain airbags may remain partially inflated for some time after they deploy.

WARNING

After an airbag inflates, take the following precautions:

- Open your windows and doors as soon as possible after impact to reduce prolonged exposure to the smoke and powder released by the inflating airbag.
 - Do not touch the airbag storage area's internal components immediately after an airbag has inflated. The parts that come into contact with an inflating airbag may be very hot.
 - Always wash exposed skin areas thoroughly with cold water and mild soap.
 - We recommend that an authorized HYUNDAI dealer replace the airbag immediately after deployment. Airbags are designed to be used only once.
-

Noise and smoke from inflating airbag

When the airbags inflate, they make a loud noise and may produce smoke and powder in the air inside of the vehicle. This is normal and is a result of the ignition of the airbag inflator. After the airbag inflates, you may feel substantial discomfort in breathing because of the contact of your chest with both the seat belt and the airbag, as well as from breathing the smoke and powder. The powder may aggravate asthma for some people. If you experience breathing problems after an airbag deployment, seek medical attention immediately.

Though the smoke and powder are nontoxic, they may cause irritation to the skin, eyes, nose, throat, etc. If this is the case, wash and rinse with cold water immediately and seek medical attention if the symptoms persist.

Do not install a Child Restraint System on the front passenger seat

Type A



Type B

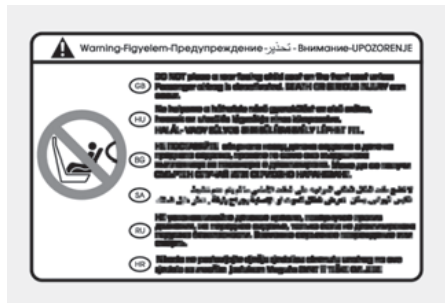

Never install a Child Restraint System in the front passenger seat, unless the airbag is deactivated

⚠️ WARNING

NEVER use a rearward facing Child Restraint on a seat protected by an ACTIVE AIRBAG in front of it, DEATH or SERIOUS INJURY to the CHILD can occur.

Why didn't my airbag go off in a collision?

There are certain types of accidents in which the airbag would not be expected to provide additional protection. These include rear impacts, second or third collisions in multiple impact accidents, as well as low speed impacts. Damage to the vehicle indicates a collision energy absorption, and is not an indicator of whether or not an airbag should have inflated.

Airbag collision sensors

WARNING

To reduce the risk of an airbag deploying unexpectedly and causing serious injury or death:

- Do not hit or allow any objects to impact the locations where airbags or sensors are installed.
- Do not perform maintenance on or around the airbag sensors. If the location or angle of the sensors is altered, the airbags may deploy when they should not or may not deploy when they should.
- Installing bumper guards with non-genuine HYUNDAI or non-equivalent parts may adversely affect the collision and airbag deployment performance.

To ensure correct function of the airbag system, we recommend to replace the bumper with genuine HYUNDAI part or the equivalent (of the genuine part) specified for your vehicle.

- Press the Start/Stop button to the OFF or ACC position and wait for 3 minutes when the vehicle is being towed to prevent inadvertent airbag deployment.
 - We recommend that all airbag repairs are conducted by an authorized HYUNDAI dealer.
-

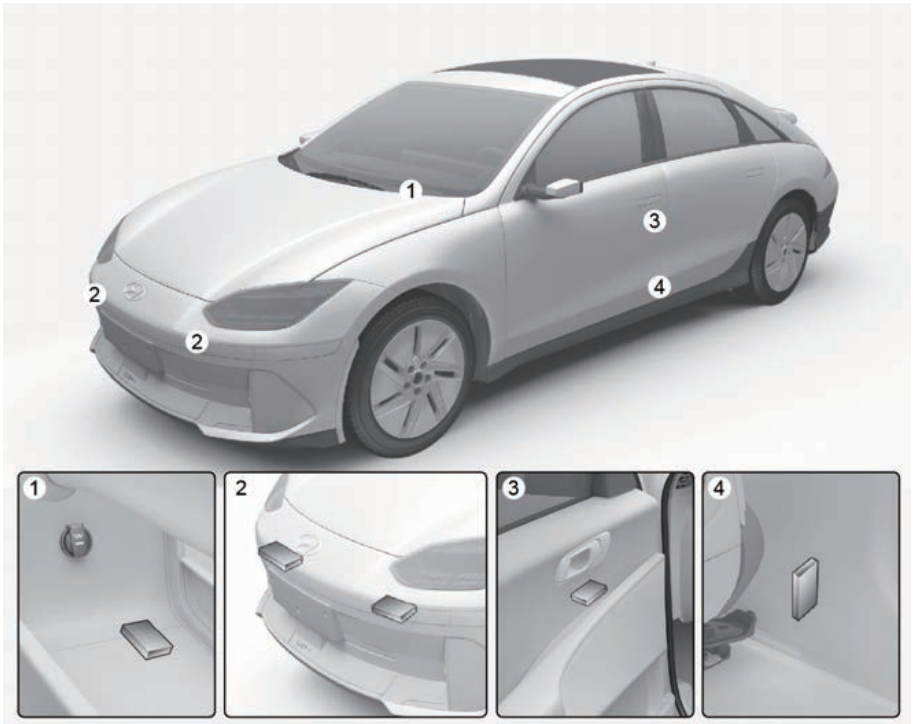

- (1) SRS control module / Rollover sensor
- (2) Front impact sensor
- (3) Side impact sensor (Pressure)
- (4) Side impact sensor (Acceleration)

Airbag inflation conditions

Front airbags

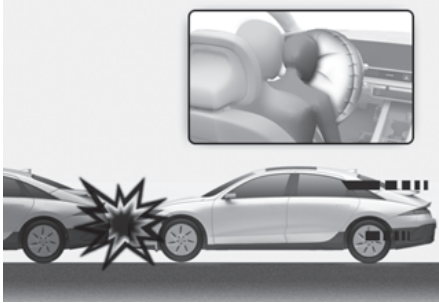

Front airbags are designed to inflate in a frontal collision depending on the severity of impact of the front collision.

Side and curtain airbags and front center side airbag

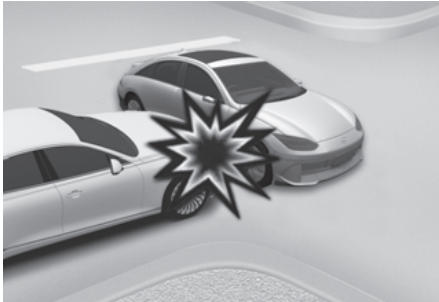

Side and curtain airbags and the front center side airbag are designed to inflate when an impact is detected by side collision sensors depending on the severity of impact resulting from a side impact collision.

Although the driver's and front passenger's airbags are designed to inflate in frontal collisions, they also may inflate in other types of collisions if the front impact sensors detect a sufficient impact. Side and curtain airbags and the front center side airbag are designed to inflate in side impact collisions, but they may inflate in other collisions if the side impact sensors detect a sufficient impact.

Also, the side and curtain airbags and the front center side airbag are designed to inflate when a rollover is detected by a rollover sensor.

If the vehicle chassis is impacted by bumps or objects on unimproved roads, the airbags may deploy. Drive carefully on unimproved roads or on surfaces not designed for vehicle traffic to prevent unintended airbag deployment.

Airbag non-inflation conditions



In certain low-speed collisions the airbags may not deploy. The airbags are designed not to deploy in such cases because they may not provide benefits beyond the protection of the seat belts.

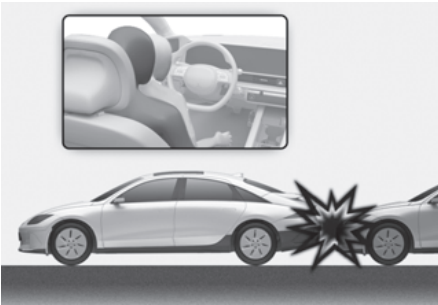

Front airbags are not designed to inflate in rear collisions, because occupants are moved backward by the force of the impact. In this case, inflated airbags would not provide any additional benefit.



Front airbags may not inflate in side impact collisions, because occupants move in the direction of the collision, and thus in side impacts, front airbag deployment would not provide additional occupant protection.

However, side and curtain airbags and front center side airbag may inflate depending on the severity of impact.

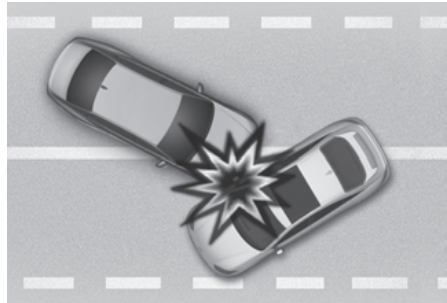

In an angled collision, the force of impact may direct the occupants in a direction where the airbags would not be able to provide any additional benefit, and thus the sensors may not deploy any airbags.



Just before impact, drivers often brake heavily. Such heavy braking lowers the front portion of the vehicle causing it to "ride" under a vehicle with a higher ground clearance. Airbags may not inflate in this "underride" situation because deceleration forces that are detected by sensors may be significantly reduced by such "underride" collisions.

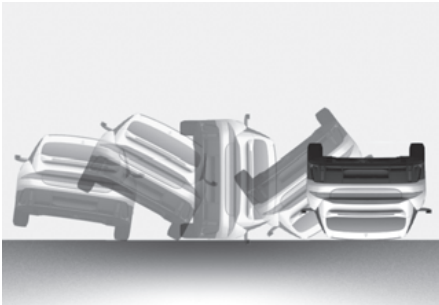

Front airbags may not inflate in rollover accidents because front airbag deployment would not provide additional occupant protection.

i Information

The side and curtain airbags and front center side airbag may inflate in a rollover situation, when it is detected by the rollover sensor.

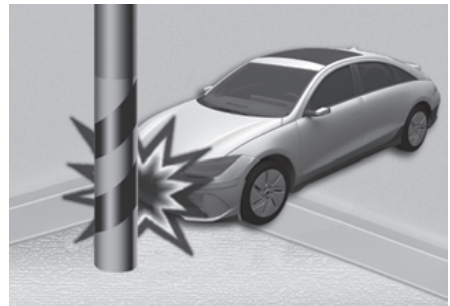

Airbags may not inflate if the vehicle collides with objects such as utility poles or trees, where the point of impact is concentrated and the collision energy is absorbed by the vehicle structure.

SRS care

The SRS is virtually maintenance-free and there are no parts you can safely service by yourself. If the SRS airbag warning light does not illuminate when the Start/Stop button is in the ON position, or continuously remains on, we recommend that the system be immediately inspected by an authorized HYUNDAI dealer.

We recommend any work on the SRS system, such as removing, installing, repairing, or any work on the steering wheel, the front passenger's panel, front seats and roof rails be performed by an authorized HYUNDAI dealer. Improper handling of the SRS system may result in serious personal injury.

WARNING

To reduce the risk of serious injury or death take the following precautions:

- Do not attempt to modify or disconnect the SRS components or wiring, including the addition of any kind of badges to the pad covers or modifications to the body structure.
 - Do not place objects over or near the airbag modules on the steering wheel, instrument panel, and the front passenger's panel above the glove box.
 - Clean the airbag pad covers with a soft cloth moistened with plain water. Solvents or cleaners could adversely affect the airbag covers and proper deployment of the system.
 - We recommend that inflated airbags be replaced by an authorized HYUNDAI dealer.
- If components of the airbag system must be discarded, or if the vehicle must be scrapped, certain safety precautions must be observed. We recommend that you consult an authorized HYUNDAI dealer for the necessary information. Failure to follow these precautions could increase the risk of personal injury.

Additional safety precautions

Passengers should not move out of or change seats while the vehicle is moving. A passenger who is not wearing a seat belt during a crash or emergency stop can be thrown against the inside of the vehicle, against other occupants, or be ejected from the vehicle.

Do not use any accessories on seat belts. Do not use any accessories on seat belts. Devices claiming to improve occupant comfort or reposition the seat belt can reduce the protection provided by the seat belt and increase the chance of serious injury in a crash.

Do not modify the front seats. Modification of the front seats could interfere with the operation of the supplemental restraint system sensing components or side airbags.

Do not place items under the front seats. Placing items under the front seats could interfere with the operation of the supplemental restraint system sensing components and wiring harnesses.

Do not cause impact to the doors. Impact to the doors when the Start/Stop button is in the ON or START position may cause the airbags to inflate.

Adding equipment to or modifying your airbag equipped vehicle

If you modify your vehicle by changing your vehicle's frame, bumper system, front end or side sheet metal or ride height, this may affect the operation of your vehicle's airbag system.

Airbag warning labels



Airbag warning labels are attached to alert the passengers of potential risks of the airbag system.

Be sure to read all of the information about the airbags that are installed on your vehicle in this Owner's Manual.

4. Instrument cluster

Instrument cluster	4-2
Instrument cluster control.....	4-3
Gauges and meters.....	4-3
Power/charge gauge	4-4
State of charge (SOC) gauge for high voltage battery.....	4-4
Reduction gear shift indicator	4-7
Warning and indicator lights	4-7
Cluster display messages.....	4-23
Cluster display	4-34
Cluster display control.....	4-34
View modes.....	4-34
Vehicle settings (infotainment system)	4-39
Setting your vehicle	4-39

Instrument cluster

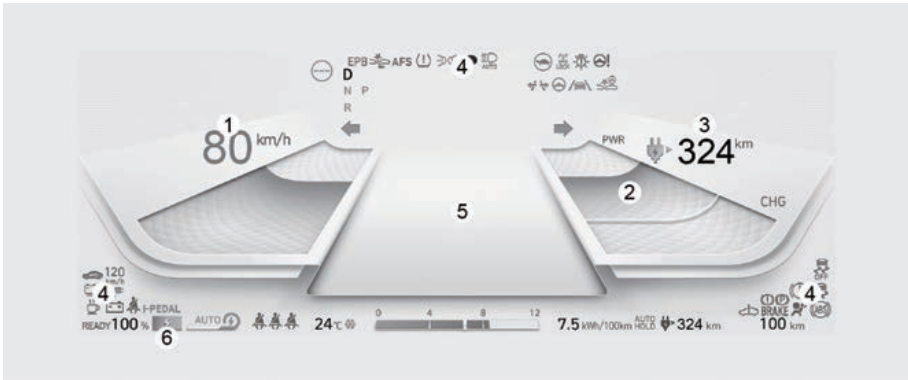

The actual instrument cluster in the vehicle may differ from the illustration. For more information, refer to the "Gauges and meters" section in this chapter.

- (1) Speedometer
- (2) Power/Charge gauge
- (3) Distance to empty
- (4) Warning indicator light
- (5) Cluster display
- (6) Battery SOC (State of Charge) gauge

i Information

- SNOW/NORMAL/ECO/SPORT mode by pressing the drive mode button will change the main theme of the instrument cluster.

Instrument cluster control

Instrument panel illumination

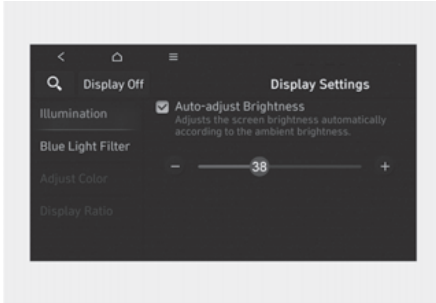

The brightness of the instrument panel can also be adjusted from the infotainment system. When Start/Stop button is in the ON position, select **Settings > Display > Illumination**.

- When **Auto-adjust Brightness** is selected from the Settings menu, the brightness is automatically adjusted.
- When the brightness of the instrument panel illumination is adjusted, the interior switch illumination intensity is also adjusted.

WARNING

Never adjust the instrument cluster while driving. This could result in loss of control and lead to an accident that may cause death, serious injury, or vehicle damage.

Gauges and meters

Speedometer

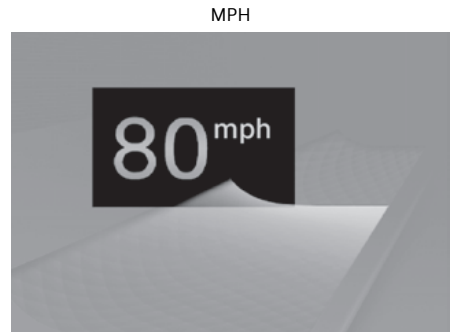
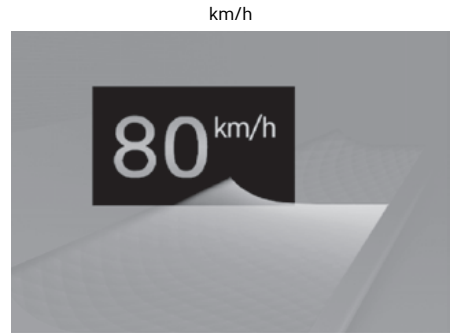

The speedometer indicates the speed of the vehicle and is calibrated in kilometers per hour (km/h) and/or miles per hour (mph).

Power/charge gauge

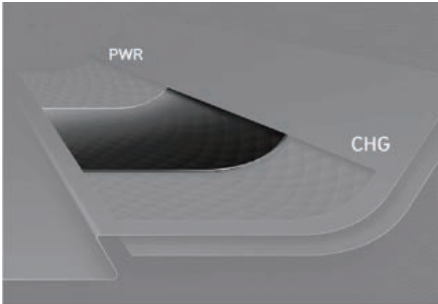

The Power/Charge Gauge shows the energy consumption rate of the vehicle and the charge/discharge status of the regenerative brakes.

- **POWER:**

It shows the energy consumption rate of the vehicle when driving uphill or accelerating. The more electric energy is used, the higher the gauge level.

- **CHARGE:**

It shows the charging status of the battery when it is being charged by the regenerative brakes (decelerating or driving on a downhill road). The more electric energy is charged, the lower the gauge level.

State of charge (SOC) gauge for high voltage battery



- The SOC gauge shows the charging status of the high voltage battery.
- The low percentage number on the indicator indicates that there is not enough energy in the high voltage battery. 100 % indicates that the driving battery is fully charged.
- When driving on highways or motorways, make sure to check in advance if the driving battery is charged enough.



When the remaining battery is lower than 20 % on the SOC gauge, the warning light (🔋) turns ON to alert you of the battery level.

When the warning light (🔋) turns ON, the vehicle can drive an additional 30-40 km (18-25 mi.) depending on the driving speed, heater/air conditioner, weather, driving style, and other factors. Charging is required.

NOTICE

The output is limited as the remaining battery is low.

When the Power Down Indicator Light is on, the vehicle may be limited to a certain speed, it may be difficult to climb hills, or the vehicle may be pushed back, so charge it immediately.

Outside temperature gauge



This gauge indicates the current outside air temperatures by 1 °C (1 °F).

Note that the temperature indicated on the cluster display may not change as quickly as the outside temperature (there may be a slight delay before the temperature changes.)

You can change the temperature unit from the Settings menu in the infotainment system. Select:

- **General Settings > Unit > Temperature Unit > °C/°F**

i Information

The infotainment system may change after software updates. For more information, refer to the manual provided in the infotainment system and the quick reference guide.

Both the temperature unit on the cluster display and climate control screen will change.

Odometer



The odometer indicates the total distance that the vehicle has been driven and should be used to determine when periodic maintenance should be performed.

Distance to empty

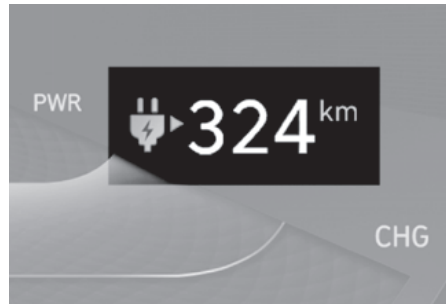

- The distance to empty is the estimated distance the vehicle can be driven with the remaining electric energy.
- The distance to empty varies depend on which drive mode is selected among SNOW/NORMAL/ECO/SPORT mode.

For more information, refer to the "Factors affecting the distance to empty" section in chapter 1.

***i* Information**

- If the vehicle is not on level ground or the battery power has been interrupted, the distance to empty function may not operate correctly.
 - The distance to empty may differ from the actual driving distance as it is an estimate of the available driving distance.
 - The distance to empty may vary significantly based on driving conditions, driving habits, and condition of the vehicle.
-

Reduction gear shift indicator



The indicator displays which gear is selected.

Regenerative braking level indicator



The regenerative brake indicates the level of the regenerative braking that you set. And it also indicates Smart regenerative system's operation status.

For more information, refer to the "Regenerative braking system (paddle shifter)" section in chapter 6.

Warning and indicator lights

i Information

Make sure that all warning lights are OFF after starting the vehicle. If any light is still ON, this indicates a situation that needs attention.

Ready indicator

READY

This indicator illuminates:

When the vehicle is ready to be driven.

- ON: Normal driving is possible.
- OFF: Normal driving is not possible, or a problem has occurred.
- Blinking: Emergency driving.

When the ready indicator goes OFF or blinks, there is a problem with the system. In this case, we recommend that you have your vehicle inspected by an authorized HYUNDAI dealer.

Service warning light



This warning light illuminates:

- When the Start/Stop button is in the ON position.
 - It illuminates for about 3 seconds and then goes off.
- When there is a problem with related parts of the electric vehicle control system, such as sensors, etc.

When the warning light illuminates while driving, or does not go OFF after starting the vehicle, we recommend that you have your vehicle inspected by an authorized HYUNDAI dealer.

Power down indicator light



This indicator light illuminates:

- When the Start/Stop button is in the ON position.
 - It illuminates for about 3 seconds and then goes off.
- When the power is limited for the safety of the high-powered parts of an electric vehicle. The power is limited for the following reasons. (Unless both Service warning light and Power down indicator light illuminate at the same time, it is not a failure.)
 - The high voltage battery level is too low or voltage is decreasing
 - The temperature of the high voltage battery is too high or too low
 - The temperature of the motor is high

NOTICE

- Do not accelerate or start the vehicle suddenly when the Power down indicator light is ON.
 - When the power is limited for the safety of the high-powered parts of an electric vehicle, the Power down indicator light illuminates. Your vehicle may not be driven, or may roll back on a slope with the indicator light ON due to the limitation of vehicle power.
-

Charging connector indicator light

This warning light indicates the connection status of the charging connector. When the charging connector is connected to the vehicle, the green light illuminates for about 1 minute.

High voltage battery level warning light

This warning light illuminates:

- When the high voltage battery level is low.
- When the warning light turns ON, charge the battery immediately.

Seat belt warning light

This warning light informs the driver that the seat belt is not fastened.

For more information, refer to the "Seat belts" section in chapter 3.

Airbag warning light

This warning light illuminates:

- When you set the Start/Stop button to the ON position.
 - The airbag warning light illuminates for about 6 seconds and then turns off when all checks have been performed.
- The airbag warning light will remain illuminated if there is a malfunction with the Safety Restraint System (SRS) airbag operation.

If this occurs, we recommend that you have the vehicle inspected by an authorized HYUNDAI dealer.

Regenerative brake warning light



This warning light illuminates:

When the regenerative brake does not operate and the brake does not perform well. This causes the Brake warning light (red) and Regenerative brake warning light (yellow) to illuminate simultaneously.

In this case, drive safely and we recommend that you have your vehicle inspected by an authorized HYUNDAI dealer.

The operation of the brake pedal may be more difficult than normal and the braking distance can increase.

Parking brake & brake fluid warning light



This warning light illuminates:

- When you set the Start/Stop button in the ON position.
 - It illuminates for about 3 seconds.
 - It remains on if the parking brake is applied.
- When the parking brake is applied.
- When the brake fluid level in the reservoir is low.
 - If the warning light illuminates with the parking brake released, it indicates the brake fluid level in the reservoir is low.
- When the regenerative brake does not operate.

If the brake fluid level in the reservoir is low:

1. Drive carefully to the nearest safe location and stop your vehicle.

2. With the motor stopped, check the brake fluid level immediately and add fluid as required (**For more information, refer to the "Brake fluid" section in chapter 9**). After adding brake fluid, check all brake components for fluid leaks. If a brake fluid leak is found, or if the warning light remains on, or if the brakes do not operate properly, do not drive the vehicle. We recommend that you have the vehicle inspected by an authorized HYUNDAI dealer.

Dual-diagonal braking system

Your vehicle is equipped with dual-diagonal braking system. This means you still have braking on two wheels even if one of the dual systems should fail.

With only one of the dual systems working, more than normal pedal travel and greater pedal pressure is required to stop the vehicle.

Also, the vehicle will not stop in as short a distance with only a portion of the brake system working.

If the brakes fail while you are driving, shift to a lower gear for additional vehicle braking and stop the vehicle as soon as it is safe to do so.

WARNING

Parking brake & Brake fluid warning light

Driving the vehicle with a warning light ON is dangerous. If the Parking brake & Brake fluid warning light illuminates with the parking brake released, it indicates that the brake fluid level is low.

If this occurs, we recommend that you have the vehicle inspected by an authorized HYUNDAI dealer.

Anti-lock Brake System (ABS) warning light



This warning light illuminates:

- When you set the Start/Stop button to the ON position.
 - The ABS warning light illuminates for about 3 seconds and then goes off.
- Whenever there is a malfunction with the ABS.

Note that the hydraulic braking system will still be operational even if there is a malfunction with the ABS.

If this occurs, we recommend that you have the vehicle inspected by an authorized HYUNDAI dealer.

Electronic Brake Force Distribution (EBD) system warning light



When the ABS warning and Parking brake warning lights are on simultaneously, it may indicate a problem with the Electronic Brake Force Distribution system.

If this occurs, we recommend that you have the vehicle inspected by an authorized HYUNDAI dealer.

⚠ WARNING

Electronic Brake Force Distribution (EBD) system warning light

When both ABS and Parking brake & Brake fluid warning lights are on, the brake system will not work normally and you may experience an unexpected and dangerous situation during sudden braking.

If this occurs, avoid high speed driving and abrupt braking.

We recommend that you have the vehicle inspected by an authorized HYUNDAI dealer as soon as possible.

NOTICE

Electronic Brake Force Distribution (EBD) system warning light

When the ABS warning light is on or both ABS and Parking brake & Brake fluid warning lights are on, the speedometer, odometer, or tripmeter may not work. Also, the MDPS warning light may illuminate and the steering effort may increase or decrease.

If this occurs, we recommend that you have the vehicle inspected by an authorized HYUNDAI dealer as soon as possible.

Motor Driven Power Steering (MDPS) warning light



This warning light illuminates:

- When you set the Start/Stop button to the ON position.
 - The electric powering steering warning light illuminates for about 3 seconds and then goes off.
- Whenever there is a malfunction with the electric power steering.

If this occurs, we recommend that you have the vehicle inspected by an authorized HYUNDAI dealer.

Master warning light



This warning light illuminates:

When there is a malfunction in operation in any of the following systems:

- Forward Collision-Avoidance Assist malfunction (if equipped)
- Forward Collision-Avoidance Assist radar blocked (if equipped)
- Blind-Spot Collision-Avoidance Assist malfunction (if equipped)
- Blind-Spot Collision-Avoidance Assist radar blocked (if equipped)
- LED headlight malfunction (if equipped)
- High Beam Assist malfunction (if equipped)
- Smart Cruise Control malfunction (if equipped)
- Smart Cruise Control radar blocked (if equipped)
- Tire Pressure Monitoring System (TPMS) malfunction

To identify the details of the warning, look at the cluster display.

Electronic Parking Brake (EPB) warning light

EPB

This warning light illuminates:

- When you set the Start/Stop button to the ON position.
 - The EPB warning light illuminates for about 3 seconds and then goes off.
- Whenever there is a malfunction with EPB.

If this occurs, we recommend that you have the vehicle inspected by an authorized HYUNDAI dealer.

i Information

The Electronic Parking Brake (EPB) warning light may illuminate when the Electronic Stability Control (ESC) indicator light comes on to indicate that ESC is not working properly. This does not indicate malfunction of EPB.

Low tire pressure warning light



This warning light illuminates:

- When you set the Start/Stop button to the ON position.
 - The low tire pressure warning light illuminates for about 3 seconds and then goes off.
- When one or more of your tires are significantly underinflated. (The location of the underinflated tires are displayed on the cluster display.)

For more information, refer to the "Tire Pressure Monitoring System (TPMS)" section in chapter 8.

This warning light remains ON after blinking for about 60 seconds, or repeatedly blinks ON and OFF in 3 second intervals:

When there is a malfunction with the TPMS.

If this occurs, we recommend that you have the vehicle inspected by an authorized HYUNDAI dealer as soon as possible.

For more information, refer to the "Tire Pressure Monitoring System (TPMS)" section in chapter 8.

WARNING

Safe Stopping

- The TPMS cannot alert you to severe and sudden tire damage caused by external factors.
 - If you notice any vehicle instability, immediately take your foot off the accelerator pedal, apply the brakes gradually with light force, and slowly move to a safe position off the road.
-

Driver attention warning light

+ if equipped

**This indicator light illuminates:**

- When the Start/Stop button is in the ON position, the yellow indicator light illuminates for about 3 seconds and then goes off
- [Continuously Yellow] When the front view camera is blocked or Driver Attention Warning is disable/malfunction
- [Blinking Yellow] When the function suggest that the driver take a break

If the yellow warning light is still on even after removing foreign material from the front of the sensor, we recommend that you have the vehicle inspected by an authorized HYUNDAI dealer as soon as possible.

For more information, refer to the "Driver Attention Warning (DAW)" section in chapter 7.

Forward safety warning light

+ if equipped

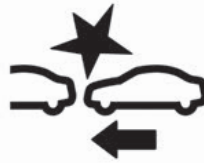
**This warning light illuminates:**

- When you set the Start/Stop button to the ON position, the yellow warning light illuminates for about 3 seconds and then goes off
- [Yellow] When Forward Safety is deselected or Forward Collision-Avoidance Assist disable/malfunction
- [Blinking Red] When Forward Safety/Forward Cross-Traffic Safety of Forward Collision-Avoidance Assist is operating

If the yellow warning light is still on even after removing foreign material from the front of the sensors after Forward Safety select in settings, we recommend that you have the vehicle inspected by an authorized HYUNDAI dealer as soon as possible.

For more information, refer to the "Forward Collision Avoidance Assist (FCA)" section in chapter 7.

Emergency steering warning light

 if equipped



This warning light illuminates:

- When you set the Start/Stop button to the ON position, the yellow warning light illuminates for about 3 seconds and then goes off
- [Continuously Yellow] When Forward/Side Safety is deselected or Forward Collision-Avoidance Assist disable/malfunction
- [Blinking Red] When Forward/Side Safety of Forward Collision-Avoidance Assist is operating

If the yellow warning light is still on even after removing foreign material from the front of the sensors after Forward Safety select in settings, we recommend that you have the vehicle inspected by an authorized HYUNDAI dealer as soon as possible.

For more information, refer to the "Forward Collision Avoidance Assist (FCA)" section in chapter 7.

Lane safety indicator light

 if equipped



This indicator light illuminates:

- When the Start/Stop button is in the ON position, the yellow indicator light illuminates for about 3 seconds and then goes off
- [Gray] When Lane Keeping Assist operational conditions are not satisfied
- [Continuously Green] When Lane Keeping Assist operational conditions are satisfied
- [Blinking Green] When Lane Keeping Assist is operating
- [Yellow] When Lane Safety is deselected or Lane Keeping Assist disable/malfunction

If the yellow warning light is still on even after removing foreign material from the front of the sensor after Lane Safety select in settings, we recommend that you have the vehicle inspected by an authorized HYUNDAI dealer as soon as possible.

For more information, refer to the "Lane Keeping Assist (LKA)" section in chapter 7.

All Wheel Drive (AWD) warning light**This warning light illuminates:**

Whenever there is a malfunction with the AWD system.

If this occurs frequently, we recommend that you have the vehicle inspected by an authorized HYUNDAI dealer.

For more information, refer to the "All Wheel Drive (AWD)" section in chapter 6.

LED headlight warning light**This warning light illuminates:**

- When you set the Start/Stop button to the ON position.
 - The LED headlight warning light illuminates for about 3 seconds and then goes off.
- Whenever there is a malfunction with the LED headlight.

If this occurs, we recommend that you have the vehicle inspected by an authorized HYUNDAI dealer.

This warning light blinks:

Whenever there is a malfunction with a LED headlight related part.

If this occurs, we recommend that you have the vehicle inspected by an authorized HYUNDAI dealer.

NOTICE

Continuous driving with the LED Headlight warning light on or blinking can reduce LED headlight life.

Icy road warning light

 if equipped



This warning light is to warn the driver the road may be icy.

When the temperature on the outside temperature gauge is about below 4 °C (40 °F), the Icy road warning light and Outside Temperature Gauge blinks and then illuminates. Also, the warning chime sounds 1 time.

You can activate or deactivate Icy road warning function from the Settings menu in the infotainment system. Select:

- **Settings > Vehicle Settings > Cluster > Content Selection > Icy Road Warning**

***i* Information**

The infotainment system may change after software updates. For more information, refer to the manual provided in the infotainment system and the quick reference guide.

***i* Information**

If the Icy road warning light appears while driving, you should drive more attentively and safely refraining from over-speeding, rapid acceleration, sudden braking or sharp turning, etc.

Door open indicator light



This indicator light illuminates:

When any door or trunk is left open.

WARNING

Before driving the vehicle, confirm the door and trunk are fully closed.

CAUTION

The 12 V battery may discharge if you leave the vehicle with the Door Open indicator light illuminated.

Electronic Stability Control (ESC) indicator light



This indicator light illuminates:

- When you set the Start/Stop button to the ON position.
 - The Electronic Stability Control indicator light illuminates for about 3 seconds and then goes off.
- Whenever there is a malfunction with ESC system.
If this occurs, we recommend that you have the vehicle inspected by an authorized HYUNDAI dealer.

This indicator light blinks:

While ESC is operating.

For more information, refer to the "Electronic Stability Control (ESC)" section in chapter 6.

Electronic Stability Control (ESC) OFF indicator light



This indicator light illuminates:

- When you set the Start/Stop button to the ON position.
 - The ESC OFF indicator light illuminates for about 3 seconds and then goes off.
- When you deactivate ESC system by pressing the ESC OFF button.

For more information, refer to the "Electronic Stability Control (ESC)" section in chapter 6.

Immobilizer indicator light



This indicator light illuminates for up to 30 seconds:

When the vehicle detects the smart key in the vehicle with the Start/Stop button in the ACC or ON position.

- Once the smart key is detected, you can start the vehicle.
- The indicator light goes off after starting the vehicle.

This indicator light blinks for a few seconds:

When the smart key is not in the vehicle.

- If the smart key is not detected, you cannot start the vehicle.

This indicator light illuminates for 2 seconds and goes off:

If the smart key is in the vehicle and the Start/Stop button is ON, but the vehicle cannot detect the smart key.

If this occurs, we recommend that you have the vehicle inspected by an authorized HYUNDAI dealer.

This indicator light blinks:

Whenever there is a malfunction with the immobilizer system.

If this occurs, we recommend that you have the vehicle inspected by an authorized HYUNDAI dealer.

Turn signal indicator light



This indicator light blinks:

When you operate the turn signal indicator stalk.

If any of the following occur, there may be a malfunction with the turn signal system.

- The turn signal indicator light illuminates but does not blink
- The turn signal indicator light blinks rapidly
- The turn signal indicator light does not illuminate at all

If any of these conditions occur, we recommend that you have the vehicle inspected by an authorized HYUNDAI dealer.

High beam indicator light

This indicator light illuminates:

- When the headlights are on and in the high beam position
- When the turn signal lever is pulled into the Flash-to-Pass position.

Low beam indicator light

This indicator light illuminates:

When the headlights are on.

Light ON indicator light

This indicator light illuminates:

When the position lights or headlights are on.

Rear fog indicator light

† if equipped



This indicator light illuminates:

When the rear fog lights are on.

High Beam Assist indicator light

 if equipped



This indicator light illuminates:

When the high-beam is on with the light switch in the AUTO position.

- White: When High Beam Assist is ready to operate.
- Green: When High Beam Assist is operating.

If your vehicle detects oncoming or preceding vehicles, High Beam Assist will switch the high beam to low beam automatically.

For more information, refer to the "High Beam Assist (HBA)" section in chapter 5.

Intelligent Front-Lighting System indicator light

 if equipped



This indicator light illuminates:

When the high-beam is on with the light switch in the AUTO position.

- White: When Intelligent Front-Lighting system is ready to operate.
- Green: When Intelligent Front-Lighting system is operating.
- [Yellow] Whenever there is a malfunction with the Auto Hold function.

If your vehicle detect oncoming or preceding vehicles, the Intelligent Front-Lighting system partially turns off the high beam LED lamps.

For more information, refer to the "Intelligent Front-Lighting System (IFS)" section in chapter 5.

AUTO HOLD indicator light

AUTO HOLD

This indicator light illuminates:

- [White] When you activate Auto Hold by pressing the AUTO HOLD switch.
- [Green] When you stop the vehicle completely by depressing the brake pedal with Auto Hold activated.
- [Yellow] Whenever there is a malfunction with the Auto Hold function.

For more information, refer to the "Electronic Parking Brake (EPB)" section in chapter 6.

Cluster display messages

Shift to P

This message is displayed if you try to turn off the vehicle without the gear in the P (Park) position.

If this occurs, the Start/Stop button turns to the ACC position.

Low key battery

This message is displayed if the battery of the smart key is discharged while changing the Start/Stop button to the OFF position.

Press START button while turning wheel

 if equipped

This message is displayed if the steering wheel does not unlock normally when the Start/Stop button is pressed.

You should press the Start/Stop button while turning the steering wheel right and left.

Press brake pedal to start vehicle

This message is displayed if the Start/Stop button changes to the ACC position twice by pressing the button repeatedly without depressing the brake pedal.

You can start the vehicle by depressing the brake pedal and then pressing the Start/Stop button.

Key not in vehicle

This message is displayed if the smart key is not in the vehicle when you leave the vehicle with the Start/Stop button in the ON or Start position.

Always turn off the vehicle before leaving your vehicle.

Key not detected

This message is displayed if the smart key is not detected when you press the Start/Stop button.

Press START button again

This message is displayed if you were unable to start the vehicle when the Start/Stop button was pressed.

If this occurs, attempt to start the vehicle by pressing the Start/ Stop button again.

If the warning message appears each time you press the Start/Stop button, we recommend that you have the vehicle inspected by an authorized HYUNDAI dealer.

Press START button with key

This message is displayed if you press the Start/Stop button while the warning message '**Key not detected**' is displayed.

At this time, the Immobilizer indicator light blinks.

Check BRAKE SWITCH fuse

This message is displayed if the brake switch fuse is disconnected.

You need to replace the fuse with a new one before starting the vehicle.

If that is not possible, you can start the vehicle by pressing the Start/Stop button for 10 seconds in the ACC position.

Shift to P to start vehicle

This message is displayed if you try to start the vehicle in any other position except P (Park) or N (Neutral).

Check smart key system

This message is displayed when there is a problem with the smart key system. We recommend that you have the vehicle inspected by an authorized HYUNDAI dealer.

Door, Hood, Trunk open indicator Indicator

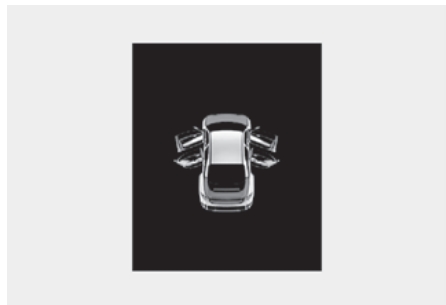

This warning is displayed if any door or hood or trunk is left open. The warning will indicate which door is open in the display.

⚠ CAUTION

Before driving the vehicle, you should confirm that the door/hood/trunk are fully closed.

Low tire pressure



This warning message is displayed if the tire pressure is low. The corresponding tire on the vehicle will be illuminated.

For more information, refer to the "Tire Pressure Monitoring System (TPMS)" section in chapter 8.

Lights

Type A

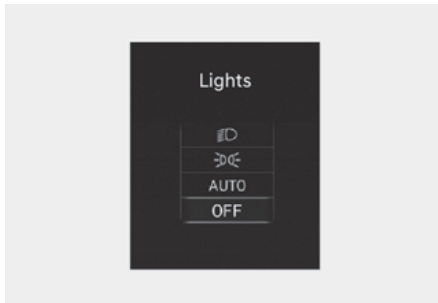

Type B



This indicator displays which exterior light is selected using the lighting control.

You can activate or deactivate **Wiper/Lights** display function from the Settings menu in the infotainment system. Select:

- **Setup > Vehicle Settings > Cluster > Content Selection > Wiper/Lights Display**

i Information

The infotainment system may change after software updates. For more information, refer to the manual provided in the infotainment system and the quick reference guide.

Wiper

Type A



Type B

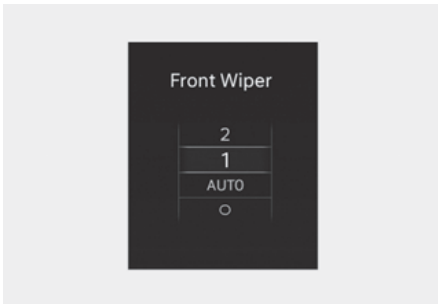

This indicator displays which wiper speed is selected using the wiper control.

You can activate or deactivate **Wiper/Lights** display function from the Settings menu in the infotainment system. Select:

- **Setup > Vehicle Settings > Cluster > Content Selection > Wiper/Lights Display**

For more information, refer to the manual provided in the infotainment system and the quick reference guide.

Low washer fluid

+if equipped

This message is displayed if the washer fluid level in the reservoir is nearly empty. Have the washer fluid reservoir refilled.

Check haptic steering wheel system

+if equipped

This message is displayed if there is a problem with the haptic steering wheel system. We recommend that you have the vehicle inspected by an authorized HYUNDAI dealer.

Check headlight

+if equipped

This message is displayed if the headlights are not operating properly. A lamp may need to be replaced.

Make sure to replace the burned out bulb with a new one of the same wattage rating.

Check turn signal

+if equipped

This message is displayed if the turn signal lamps are not operating properly. A lamp may need to be replaced.

Make sure to replace the burned out bulb with a new one of the same wattage rating.

Check headlamp LED

+if equipped

This message is displayed if there is a problem with the LED headlamp. We recommend that you have the vehicle inspected by an authorized HYUNDAI dealer.

Shift to P to charge/Shift to P to start charging

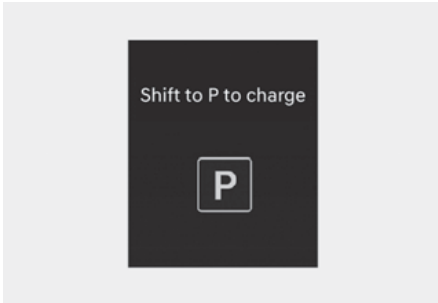

This message is displayed if you connect the charging cable without the gear in the P (Park) position.

Shift to P (Park) before connecting the charging cable.

Remaining time

AC charge

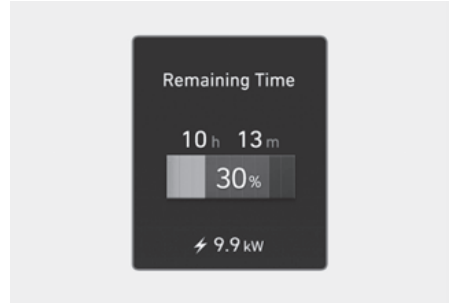

DC charge

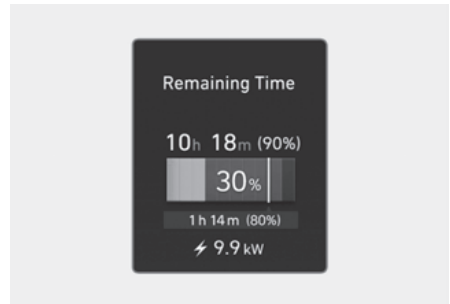

This message is displayed to notify the remaining time to charge the battery to the selected target battery charge level.

Unplug vehicle to start

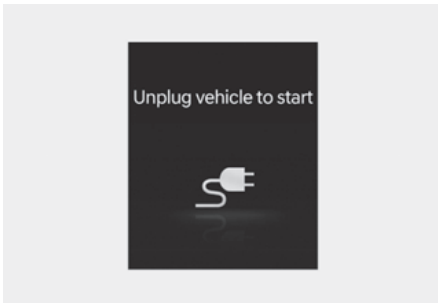

This message is displayed when you start the vehicle without unplugging the charging cable. Unplug the charging cable, and then turn on the vehicle.

Charging door open

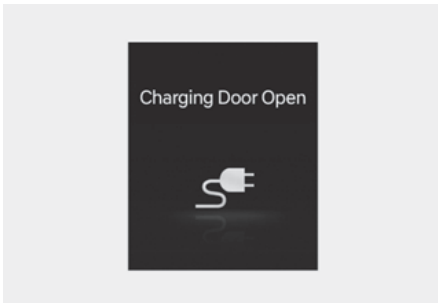

This message is displayed when the vehicle is driven with the charging door opened. Close the charging door and then start driving.

Charging Stopped. Check the AC/DC charger.

AC charge

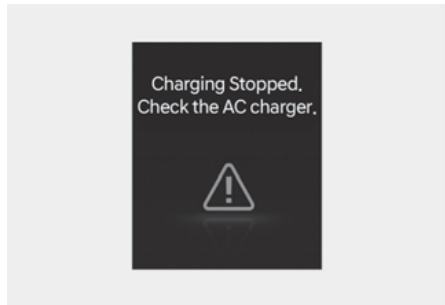

DC charge

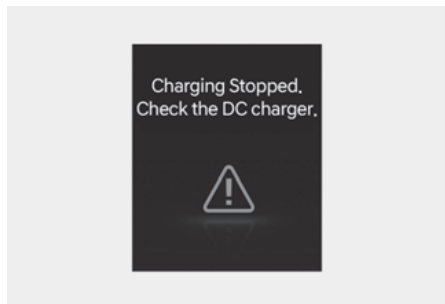

- This warning message is displayed when charging is stopped for the reasons below:
 - There is a problem with the external AC charger or DC charger
 - The external AC charger or DC charger stopped charging
 - The charging cable is damaged

In this case, check whether there is any problem with the external AC or DC charger and charging cable.

If the same problem occurs when charging the vehicle with a normally operating AC charger or genuine HYUNDAI portable charger, we recommend that you have your vehicle inspected by an authorized HYUNDAI dealer.

Charging Stopped. Check the cable connection.

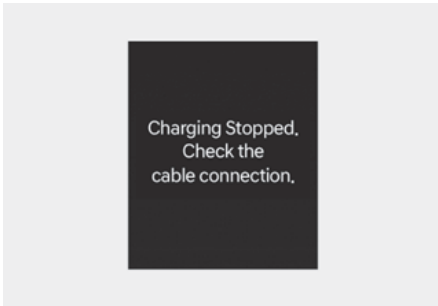

This warning message is displayed when charging is stopped because the charging connector is not correctly connected to the charging inlet

In this case, separate the charging connector and re-connect it and check whether there is any problem (external damage, foreign substances, etc.) with the charging connector and charging inlet.

If the same problem occurs when charging the vehicle with a replaced charging cable or genuine HYUNDAI portable charger, we recommend that you have your vehicle inspected by an authorized HYUNDAI dealer.

Check regenerative brakes

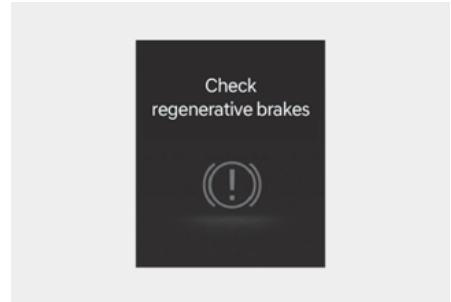

These warning messages are displayed when the regenerative brake system does not work properly.

In this case, we recommend that you have the vehicle inspected by an authorized HYUNDAI dealer.

Low EV battery

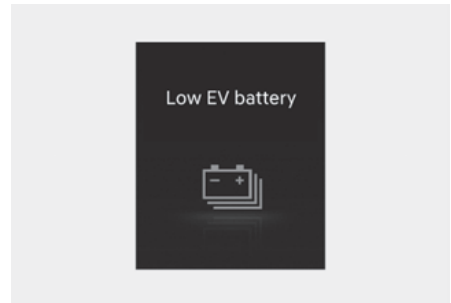

When the high voltage battery level reaches below about 20 %, this warning message is displayed.

The warning light on the instrument cluster (🔋) will turn ON simultaneously.

Charge the high voltage battery immediately.

Charge immediately. Power limited.

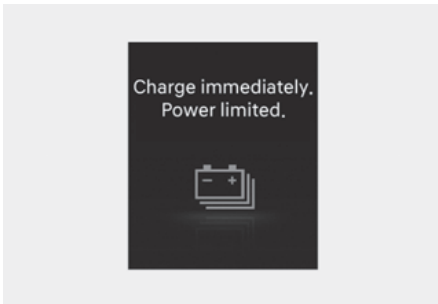

When the high voltage battery level reaches below about 10 %, this warning message is displayed.

The warning light on the instrument cluster (🔋) will turn on simultaneously.

The vehicle's power will be reduced to minimize the energy consumption of the high voltage battery. Charge the battery immediately.

Battery discharging due to external electrical devices

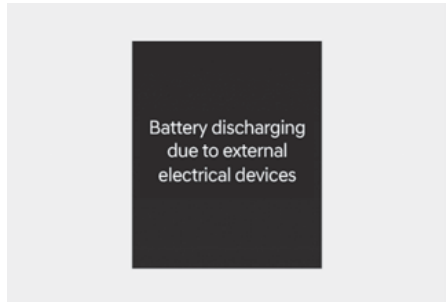

This warning message is displayed when a battery discharge due to excessive current is detected by mounting an unauthorized electrical device such as a black box.

Be careful as it may cause battery discharge problems.

If the warning message is not disappeared after the external electrical device is removed, we recommend that you have the vehicle inspected by an authorized HYUNDAI dealer.

Power limited due to low EV battery temperature. Charge battery.

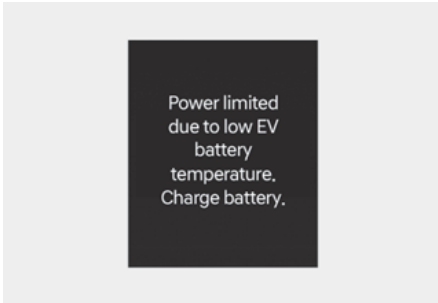

Both warning messages are displayed to protect electric vehicle system when outside temperature is low. If the high voltage battery charging level is low and parked outside in low temperature for a long time, vehicle power could be limited. Charging the battery before driving helps increase power.

NOTICE

If these warning messages are still displayed even after the ambient temperature has increased, we recommend that you have the vehicle inspected by an authorized HYUNDAI dealer.

Power limited

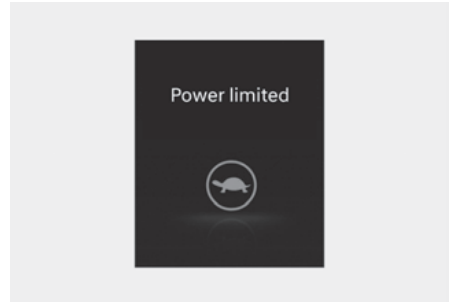

This warning message is displayed:

- When the Start/Stop button is in the ON position.
 - It illuminates for about 3 seconds and then goes off.
- When the power is limited for the safety of the high-powered parts of an electric vehicle. The power is limited for the following reasons. (Unless both Service warning light and Power down indicator light illuminate at the same time, it is not a failure.)
 - The high voltage battery level is too low or voltage is decreasing
 - The temperature of the high voltage battery is too high or too low
 - The temperature of the motor is high

NOTICE

- When this warning message is displayed, do not accelerate or start the vehicle suddenly.
- When the power is limited for the safety of the high-powered parts of an electric vehicle, the warning message is displayed. Your vehicle may not be driven, or may roll back on a slope with the warning message displayed due to the limitation of vehicle power.

Stop vehicle and check power supply

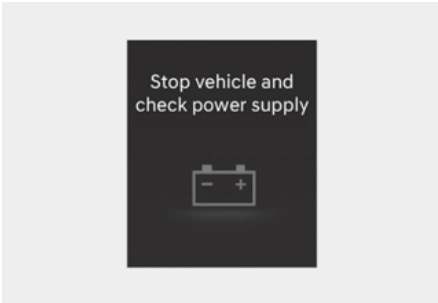

This warning message is displayed when a failure occurs in the power supply system.

In this case, park the vehicle in a safe location and we recommend that you tow your vehicle to the nearest authorized HYUNDAI dealer and have the vehicle inspected.

Check active air flap system

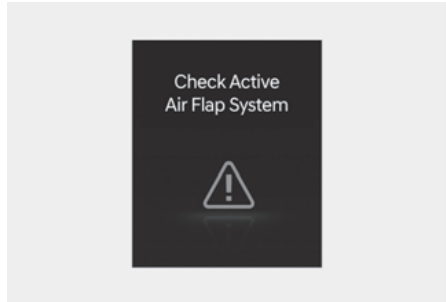

This warning message is displayed in the following situations:

- There is a malfunction with the actuator flap
- There is a malfunction with the actuator air flap controller
- The air flap does not open

When all of the above conditions are fixed, the warning will disappear.

Check virtual engine sound system

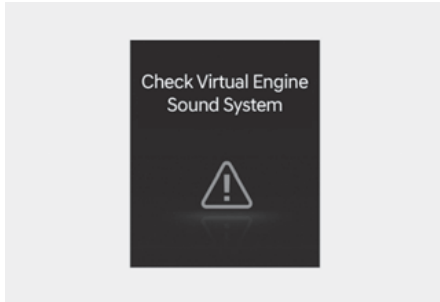

This message is displayed when there is a problem with the Virtual Engine Sound System (VESS).

In this case, we recommend that you have the vehicle inspected by an authorized HYUNDAI dealer.

Check electric vehicle system

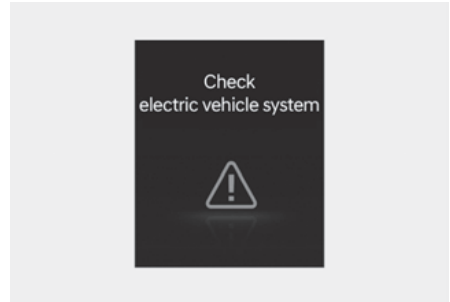

This warning message is displayed when there is a problem with the electric vehicle control system.

Refrain from driving when the warning message is displayed.



In this case, we recommend that you have the vehicle inspected by an authorized HYUNDAI dealer.

Cluster display

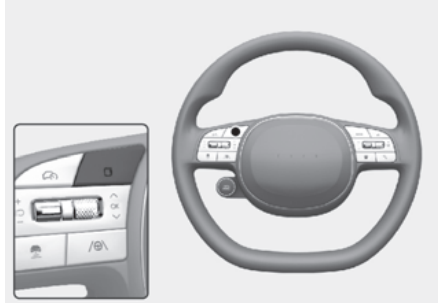
Cluster display control



The cluster display modes can be changed by using the control switches.

Switch	Operation	Function
	Press	MODE button for changing View modes
	Press	UP, DOWN switch for changing items in Utility view and Option menu
OK	Press	SELECT/RESET switch for entering Option menu
	Press and hold	SELECT/RESET switch for retrieving assist information or resetting the selected item

View modes

View modes	Explanation
Driving Assist	Driving Assist view displays the status of the vehicle's Driver Assistance systems.
Turn by Turn	Turn By Turn view displays the state of the navigation.
Utility	Utility view displays driving information such as the trip distance, electric energy economy and etc.

The information provided may differ depending on which features are applicable to your vehicle.

Type A

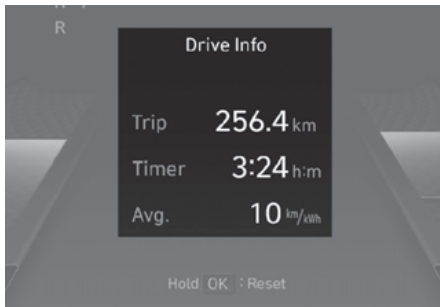

Type B

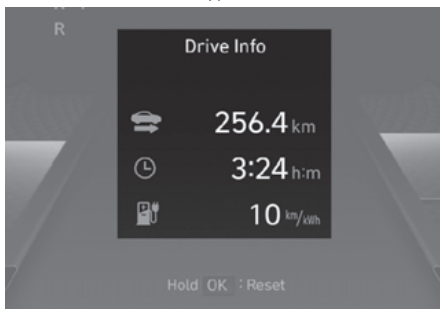

Driving Assist, Turn by Turn, Utility view modes are displayed in the center (A) of the instrument cluster.

Driving assist view



The status of Smart Cruise Control, Lane Following Assist, Highway Driving Assist, etc., is displayed when Driving Assist view is selected.

For more information, refer to each function information section in chapter 7.

Turn By Turn (TBT) view

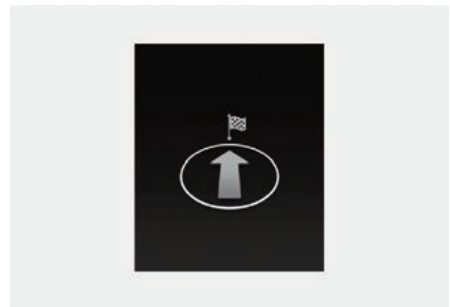

Turn-by-turn navigation, distance/time to destination information is displayed when Turn by Turn view is selected.

Utility view

In the Utility view, using the \wedge, \vee (UP, DOWN) switch, you may change through items in the following order.

Type A

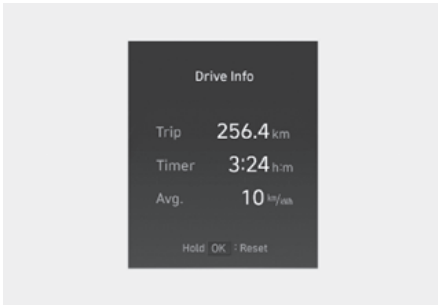

Type B

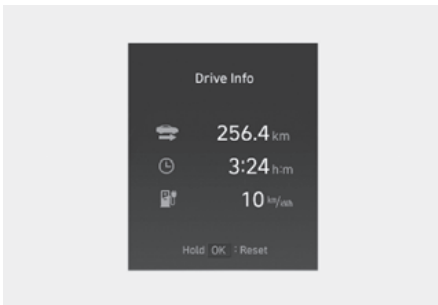

Drive info

Trip distance, average electric energy economy and total driving time are displayed.

The driver's door is opened after turning off the vehicle or the vehicle is turned on after 3 minutes have passed, the Drive Info screen will reset.

After Recharging

Type A

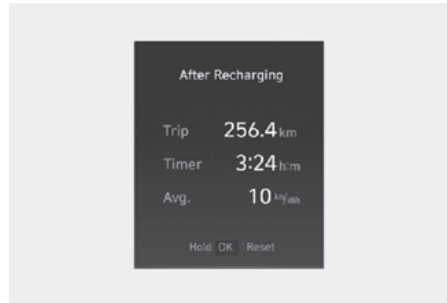

Type B

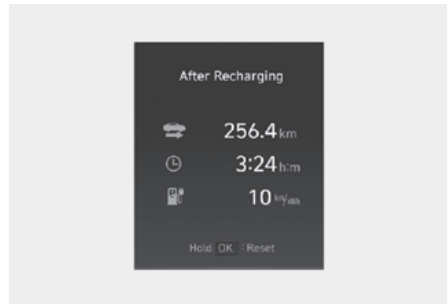

After Recharging

Trip distance, total driving time and average energy consumption after the vehicle has been recharged are displayed. To reset manually, press the OK button on the steering wheel for more than 1 second when 'After recharging' is displayed.

Accumulated info

Type A

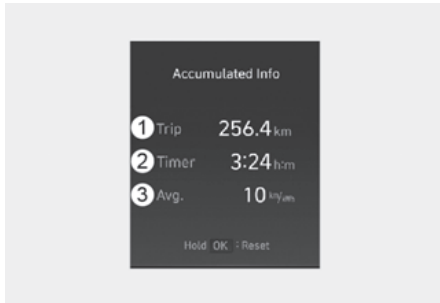

Type B

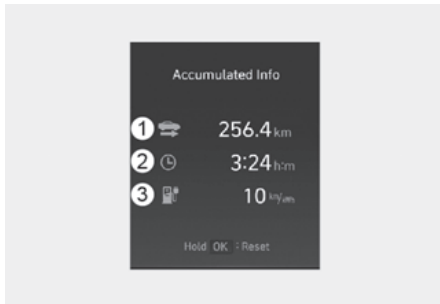

This display shows the accumulated trip distance (1), the total driving time (2) and average energy consumption(3).

The information is accumulated starting from the last reset.

To manually reset the information, press and hold the OK button when viewing the Accumulated driving info. The trip distance, the average energy consumption, and total driving time will reset simultaneously.

The accumulated driving information will continue to be counted while the vehicle is in the ready (READY) mode (for example, when the vehicle is in traffic or stopped at a stop light).

i Information

The vehicle must be driven for a minimum of 300 m (0.19 mi.) since the last ignition key cycle before the accumulated driving information is recalculated.

Tire pressure / Tyre pressure

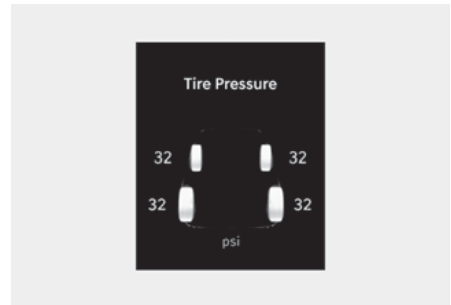

The tire pressure of each tire is displayed.

For more information, refer to the "Tire Pressure Monitoring System (TPMS)" section in chapter 8.

Energy flow / Driving force distribution

 if equipped



- The electric vehicle system informs the drivers its energy flow in various operating modes.
- The distribution status of the driving power of the front and rear wheels are displayed when Auto AWD mode is activated.

For more information, refer to the "All Wheel Drive (AWD)" section in chapter 6.

Additional information display

Drive info

Type A

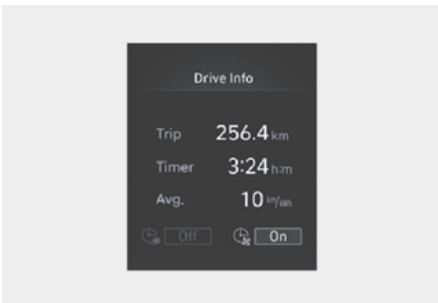

Type B



Drive information is displayed for 4 seconds after the vehicle is turned off.

Driving assist information



The current operation conditions of Cruise Control, Smart Cruise Control, Lane Following Assist, Highway Driving Assist, etc., is displayed.

Vehicle settings (infotainment system)

Vehicle Settings in the infotainment system provides user options for a variety of settings including door lock/unlock features, convenience features, driver assistance settings, etc.

Vehicle Settings menu

- Driver Assistance
- Drive Mode
- EV
- Head-Up Display
- Cluster
- Climate
- Seat
- Lights
- Door
- Convenience

i Information

The infotainment system may change after software updates. For more information, refer to the manual provided in the infotainment system and the quick reference guide.

WARNING

Do not operate the Vehicle Settings while driving. This may cause distraction resulting in an accident.

Setting your vehicle



1. Press the custom(☆) button on the main keyboard.
2. Select **Vehicle** to change the Vehicle Settings.

i Information

The infotainment system may change after software updates. For more information, refer to the manual provided in the infotainment system and the quick reference guide.

5. Convenience features

Accessing your vehicle.....	5-5
Smart key.....	5-5
Immobilizer system.....	5-12
Door locks	5-13
Operating door unlocks from outside the vehicle (Manual type)	5-13
Operating door unlocks from outside the vehicle (Electric type)	5-14
Operating door locks from outside the vehicle (Manual type).....	5-15
Operating door locks from outside the vehicle (Electric type).....	5-16
Operating door lock/unlock from inside the vehicle.....	5-17
Deadlocks	5-20
Automatic door lock and unlock features.....	5-20
Child-protector rear door locks	5-21
Theft-alarm system	5-21
Rear Occupant Alert (ROA)	5-22
System setting.....	5-22
System operation.....	5-23
Declaration of conformity	5-25
Integrated memory system	5-25
Storing memory positions.....	5-26
Recalling memory positions.....	5-26
Resetting the system.....	5-26
Seat easy access	5-27
Steering wheel	5-28
Motor Driven Power Steering (MDPS).....	5-28
Tilt/Telescopic steering	5-29
Horn	5-30
Heated steering wheel	5-30
Mirrors	5-32
Inside rearview mirror.....	5-32
Outside rearview mirrors.....	5-33
Reverse parking aid	5-35
Digital side mirror (DSM).....	5-37
Operating the digital side mirrors.....	5-38
DSM warnings and indicators	5-38
Displaying the guidelines	5-39
Adjusting the DSM cameras.....	5-39

Folding/Unfolding the DSM cameras	5-40
Switching to wide view when backing up	5-41
Setting the DSM screen brightness	5-42
DSM camera defroster	5-42
Windows	5-43
Power windows	5-45
Wide sunroof	5-48
Hood	5-52
Opening the hood.....	5-52
Closing the hood	5-53
Front trunk	5-53
Power trunk	5-55
Power trunk operating conditions	5-55
Operating the power trunk	5-56
Resetting the power trunk.....	5-59
Emergency trunk safety release.....	5-59
Smart trunk.....	5-60
Using smart trunk	5-60
Deactivating smart trunk	5-61
Detecting area	5-62
Electric charging door	5-63
Head-up display	5-64
Head-up display settings	5-64
Head-up display information.....	5-65
Precautions while using the Head-up display.....	5-65
Vehicle system OTA update	5-66
Downloading software.....	5-66
Approving software update.....	5-66
Preparing software update	5-67
Updating software.....	5-67
Lighting	5-69
Exterior lights.....	5-69
Welcome system	5-74
Interior lights	5-75
Interior lamp AUTO cut	5-75

5. Convenience features

Front lamps.....	5-76
Rear lamp	5-76
Vanity mirror lamp	5-77
Glove box lamp	5-77
Mood lamp	5-77
Front trunk lamp	5-79
Luggage compartment lamp	5-79
High Beam Assist (HBA).....	5-80
High Beam Assist settings.....	5-80
High Beam Assist operation.....	5-81
High Beam Assist malfunction and limitations.....	5-82
Intelligent Front-Lighting System (IFS).....	5-83
System setting.....	5-83
System operation.....	5-83
System malfunction and limitations.....	5-84
Wipers and washers	5-86
Front windshield wipers	5-86
Front windshield washers	5-88
Automatic climate control system	5-89
Climate.....	5-91
Automatic temperature control mode	5-91
Manual temperature control mode	5-93
System operation.....	5-101
System maintenance	5-103
Windshield defrosting and defogging	5-105
To defog inside windshield	5-105
To defrost outside windshield.....	5-106
Defogging logic.....	5-106
Rear window defroster	5-107
Climate control additional features	5-108
Auto defogging system	5-108
Auto dehumidify	5-109
Sunroof inside air recirculation.....	5-110
Recirculating air when washer fluid is used.....	5-110
Recirculating air when entering a tunnel	5-110
Automatic controls linked to climate control settings (for driver's seat)	5-111

Smart ventilation	5-111
Storage compartment	5-112
Center console storage.....	5-112
Glove box	5-113
Interior features	5-113
Cup holder	5-113
Sunvisor.....	5-114
Power outlet	5-115
USB charger.....	5-116
Wireless smartphone charging system	5-117
Vehicle to load (V2L)	5-119
Clock.....	5-119
Coat hook.....	5-119
Floor mat anchor(s).....	5-120
Infotainment system.....	5-121
USB Port	5-121
Antenna	5-121
Steering wheel remote controls.....	5-121
Infotainment system	5-122
Voice recognition	5-123
Bluetooth® Wireless Technology.....	5-123

Accessing your vehicle

Smart key

Type A



Type B

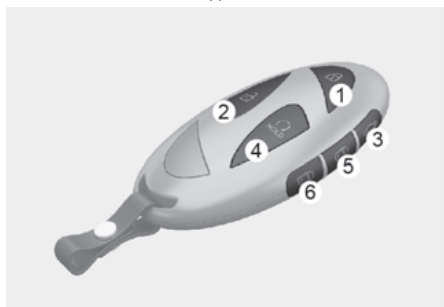

Your electric vehicle uses a Smart Key, which you can use to lock or unlock the driver and passenger doors or the rear trunk.

1. Door lock
2. Door unlock
3. Trunk open/close
4. Remote Start
5. Forward
6. Backward

Locking your vehicle

Manual type



To lock your vehicle using the door handle button or the Smart Key:

1. Make sure all doors, the hood and the trunk are closed.
2. Press the Door Lock button (1) on the Smart Key. The hazard warning lights will blink with an alarm, and the doors will be locked.
3. In addition, pushing the button on the door handle (the engraved part) while keeping the smart key will lock all doors.

Electric type (if equipped)

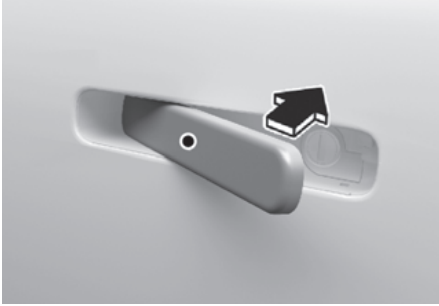

To lock your vehicle using the door handle touch sensor or the Smart Key:

1. Make sure all doors, the hood and the trunk are closed.
 2. Press the Door Lock button (1) on the Smart key. The hazard warning lights will blink with an alarm, and the handles will retract back.
- In addition, touching the touch sensor on the door handle (the engraved part) while keeping the smart key will lock all doors and let the door handle to retract back.

i Information

- The outside rearview mirror will fold if **'Enable on Door Unlock'** is selected from the Settings menu in the infotainment system. Select:
- **Setup > Vehicle Settings > Lights > Welcome Mirror/Light > Enable on Door Unlock**
- The door handle touch sensor will only operate when the smart key is within 0.7-1 m (28-40 in.) from the outside door handle.
- Touching the door handle touch sensor does not unlock the doors. To unlock the doors, refer to the following page.

Note that you cannot lock your vehicle using the door handle touch sensor if any of the following occur:

- The Smart Key is in the vehicle.
- The Start/Stop button is in ACC or ON position.
- Any of the doors are open except for the trunk.

! WARNING

Do not leave the Smart Key in your vehicle with unsupervised children. Unattended children could press the Start/ Stop button and may operate power windows or other controls, or even make the vehicle move, which could result in serious injury or death.

i Information

- To fold/unfold the rearview mirror simultaneously when the door is locked/unlocked, select **Setup (Settings) > Vehicle Settings > Lights > Welcome Mirror/Light > Enable on Door Unlock** in the infotainment screen.
- The door handle button will only operate when the smart key is within 0.7-1 m (28-40 in.) from the outside door handle. Other people can also open the doors without the smart key in possession.
- After unlocking the doors, the doors will lock automatically after 30 seconds unless a door is open.

i Information

The infotainment system may change after software updates. For more information, refer to the manual provided in the infotainment system and the quick reference guide.

Unlocking your vehicle

Manual type



To unlock your vehicle using the door handle button or the Smart Key:

1. Make sure you have the smart key in your possession.
2. Pushing the button on the door handle (engraved part) or press the Door Unlock button (2) on the smart key. All doors handles will be unlocked and the hazard warning lights will blink twice.
3. After unlocking the doors, the doors will automatically re-lock after 30 seconds unless a door is opened.

Electric type (if equipped)



To unlock your vehicle using the door handle touch sensor or the Smart Key:

1. Make sure you have the smart key in your possession.
2. Touch the touch sensor on the door handle (engraved part) or press the Door Unlock button (2) on the smart key. All door handles will pop out and the doors will be unlocked and the hazard warning lights will blink twice.
3. After unlocking the doors, the doors will automatically re-lock after 30 seconds unless a door is opened.

i Information

- The outside rearview mirror will unfold if '**Enable on Door Unlock**' is selected from the Settings menu in the infotainment system. Select:
 - **Setup > Vehicle Settings > Lights > Welcome Mirror/Light > Enable on Door Unlock**
- The door handle touch sensor will only operate when the smart key is within 0.7-1 m (28-40 in.) from the outside door handle.
- The doors may lock or unlock if the touch sensor of the outer door handle is recognized while washing your car or due to heavy rain.
- To prevent unintentional door lock or unlock:

Press the lock button on the smart key and immediately press the unlock button along with the lock button for more than 4 seconds. The hazard warning lights will blink four times. At this time, the doors will not lock or unlock even though the touch sensor is touched on the outside door handle.

To deactivate the function, press the door lock or unlock button on the smart key.
- The doors may not lock or unlock in the following situations.
 - If the touch sensor is touched with gloves on
 - If the door is suddenly approached

i Information

During a car wash or rain, in order to minimize unintentional operation of the touch sensor, the touch sensor may become insensitive. This is not a malfunction.

Opening the trunk

To open the trunk:

1. Make sure you have the smart key in your possession.
2. Press the switch on the trunk handle or press and hold the smart key button (3) on the smart key for more than 1 second. The hazard warning lights will blink two times and the trunk will open.

Press and hold the trunk open/close button (3) on the smart key to close the opened trunk. If you release the button while the trunk is being closed, it will stop working and the chime will sound for about 5 seconds.

i Information

The trunk open/close button will only operate when the smart key is within 0.7 m (28 in.) from the trunk.

Remotely starting vehicle

You can start the vehicle using the Remote Start button (4) on the smart key.

To start the vehicle remotely:

1. Press the door lock button on the smart key within 10 m (32 ft.) from the vehicle.
2. Press the Remote Start button (4) for more than 2 seconds within 4 seconds after pressing the door lock button.
3. The vehicle will start.
4. To turn off the remote start function, press the Remote Start button (4) once.

i Information

- The vehicle must be in P (Park) for the remote start function to start.
 - The vehicle turns off if you get on the vehicle without a registered smart key.
 - The vehicle turns off if you do not get on the vehicle within 10 minutes after remotely starting the vehicle.
 - The Remote Start button (4) may not operate if the smart key is not within 10 m (32 ft.).
 - The vehicle will not remotely start if the vehicle hood or trunk is opened.
-

Remotely moving vehicle forward or backward

 if equipped

With the smart key, the driver can move the vehicle forward or backward using the Forward or Backward button (5, 6) on the smart key.

For more information, refer to the "Remote Smart Parking Assist 2 (RSPA 2)" section in chapter 7.

Start-up

You can start the vehicle without inserting the key.

For more information, refer to the "Start/Stop button" section in chapter 6.

***i* Information**

If the smart key is not moved for some time, the detection function for smart key operation will pause. Lift the smart key to activate the detection again.

NOTICE

To prevent damaging the smart key:

- Keep the smart key in a cool, dry place to avoid damage or malfunction. Exposure to moisture or high temperature may cause the internal circuit of the smart key to malfunction which may not be covered under warranty.
 - Avoid dropping or throwing the smart key.
 - Protect the smart key from extreme temperatures.
-

Loss of a smart key

A maximum of three Smart Keys can be registered to a single vehicle. If you happen to lose your smart key, it is recommended that you should immediately take the vehicle and remaining keys to your authorized HYUNDAI dealer or tow the vehicle, if necessary.

Smart key precautions

The smart key may not work if any of the following occur:

- The smart key is close to a radio transmitter such as a radio station or an airport which can interfere with normal operation of the transmitter.
- The smart key is near a mobile two way radio system or a mobile phone.
- Another vehicle's smart key is being operated close to your vehicle.
- The smart key is near any normal electronic devices or credit cards.

If the smart key does not work correctly, open and close the door with the mechanical key. If you have a problem with the smart key, it is recommended to contact an authorized HYUNDAI dealer.

If the smart key is in close proximity to your mobile phone, the signal could be blocked by your mobile phone's normal operational signals. This is specifically relevant when the phone is active such as making and receiving calls, text messaging, and/or sending/receiving emails. When possible, avoid keeping the smart key and your mobile phone in the same location such as a pants or jacket pocket in order to avoid interference between the two devices.

If your windows are tinted, especially with metallic window tint, it may cause frequency interference, reducing the smart key operating range.

NOTICE

- Keep the smart key away from electromagnetic materials that blocks electromagnetic waves to the key surface.
- Always have the smart key with you when leaving the vehicle. If the smart key is left near the vehicle, the vehicle battery may be discharged.

Battery replacement

If the Smart Key is not working properly, try replacing the battery with a new one.

Battery Type: CR2450

To replace the battery:

1. Put the slim tool into the key hole (1) to pry open the rear cover of the smart key.



2. Remove the old battery and insert the new battery. Make sure the battery position is correct. An improperly positioned battery may discharge the battery, causing smart key failure.

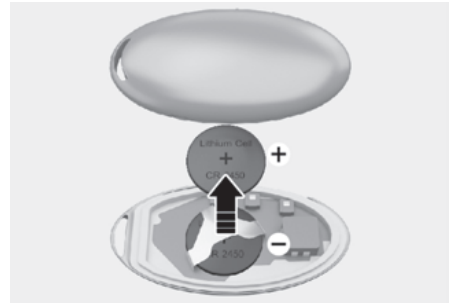

3. Reinstall the rear cover of the smart key.

If you suspect your smart key might have sustained some damage, or you feel your smart key is not working correctly, it is recommended that you contact an authorized HYUNDAI dealer.

WARNING

THIS PRODUCT CONTAINS A BUTTON BATTERY.

If swallowed, a lithium button battery can cause severe or fatal injuries within 2 hours. Keep batteries out of reach of children.

If you think batteries may have been swallowed or placed inside any part of the body, seek immediate medical attention.

i **Information**



An inappropriately disposed battery can be harmful to the environment and human health. Dispose of the battery according to your local law(s) or regulations.

Immobilizer system

The immobilizer system helps protect your vehicle from theft. If an improperly coded key (or other device) is used, the vehicle is disabled.

When the Start/Stop button is pressed to the ON position, the immobilizer system indicator should come on briefly, then go off. If the indicator starts to blink, the system does not recognize the coding of the key.

Press the Start/Stop button to the OFF position, then press the Start/Stop button to the ON position again.

In some circumstances, the vehicle may not recognize your smart key if another smart key device is nearby or a metal object such as a key chain is causing interference with the smart key.

If this occurs, your vehicle may not start. Remove any metal objects or additional keys near the smart key before attempting to start the vehicle again.

If the system repeatedly does not recognize the coding of the key, it is recommended that you contact an authorized HYUNDAI dealer.

Do not attempt to alter this system or add other devices to it. Electrical problems could result that may make your vehicle inoperable.

WARNING

In order to prevent theft of your vehicle, do not leave spare keys anywhere in your vehicle. Your immobilizer password is a customer unique password and should be kept confidential.

NOTICE

The transponder in your key is an important part of the immobilizer system. It is designed to give years of trouble-free service, however you should avoid exposure to moisture, static electricity and rough handling. Immobilizer system malfunction could occur.

Door locks

Operating door unlocks from outside the vehicle (Manual type)

Smart key

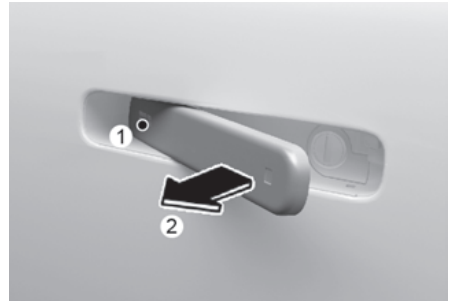

Push the button on the front outside door handle (the engraved part) while carrying the Smart Key with you, all doors will unlock.

The hazard warning lights will blink twice and chime also sounds twice.

Once the doors are unlocked, when press the front of the door handle (1) then rear of the door handle will pop out (2).

Pull the outside door handle to open the door.

Operating door unlocks from outside the vehicle (Electric type)

 If equipped

Smart key

Approach unlock system

The outside door handle will slide out and the doors will unlock when the driver approaches the vehicle possessing the smart key.

The driver can activate/deactivate the **Approach unlock** system on the infotainment screen.

To activate Approach unlock system for only the driver's seat, select **Settings > Vehicle > Door > Unlock all doors** in the infotainment system.

To activate Approach unlock system, select **Settings > Vehicle > Door > Approach unlock** in the infotainment system. The outside door handle will slide out and the door will unlock when the driver approaches the vehicle possessing the smart key. If Approaching unlock system is deactivated, the door handle will not slide out even when the driver approaches to the vehicle with the smart key. To unlock doors when Approach unlock system is deactivated, touch the lock/unlock sensor (engraved part) on the handle.

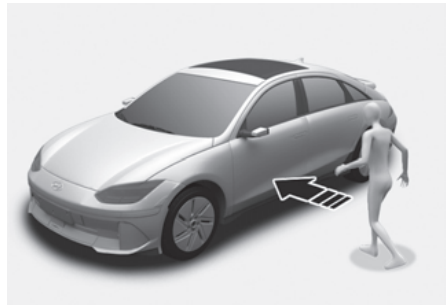

- When the '**Approach unlock**' is activated:
 - If you approach (within 1 m (40 in.)) the driver or front passenger's door handle possessing the smart key, the outside door handles slide out and the doors are unlocked. In this case, Hazard Warning Flasher blinks twice and chime also sounds twice.
 - After first approach, the vehicle tries detecting the smart key every 5 seconds and if the key is not detected, the doors will lock automatically and the handles will slide in.

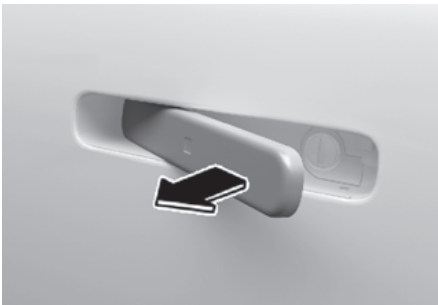

Operating door locks from outside the vehicle (Manual type)

Smart key



Push the button on the front outside door handle (the engraved part) while carrying the Smart Key with you, all doors will lock. The hazard warning lights will blink and chime also sounds once.

Push the door to close.

- When the '**Approach unlock**' is deactivated: The handle does not slide out even when you approach with the smart key in possession. The doors are unlocked if you press the outside handle as the handles slide out.
- The doors will lock automatically and the handles will slide in after 30 seconds unless a door is opened.

i Information

In emergency situations, such as battery is dead, the outside electric door handle can still be operated in a way that the outside manual door handle operate.

Operating door locks from outside the vehicle (Electric type)

 If equipped

Smart key

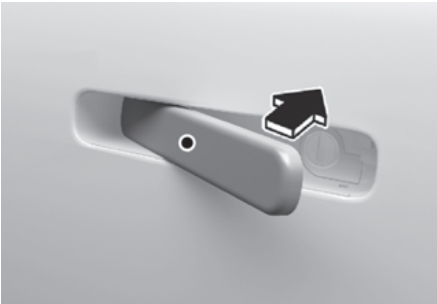

When all doors are closed, touch the touch sensor on the front outside door handle (the engraved part) while carrying the Smart Key with you, outside door handle will return and doors will be locked.

The hazard warning lights will blink and chime also sounds once.

NOTICE

- If the door is locked/unlocked multiple times in rapid succession with the smart key, door lock button or door lock switch, the system may stop operating temporarily in order to protect the circuit. Also, the **Approach unlock** system may not operate. Try operation after a sufficient time in case the system does not operate due to multiple operations.
- **Approach unlock** system is not operated continuously. Retry after a certain period of time when all the doors are closed.

i Information

- In cold and wet climates, door lock and door mechanisms may not work properly due to freezing conditions.
- If the door is locked/unlocked multiple times in rapid succession with either the vehicle key or door lock switch, the system may stop operating temporarily in order to protect the circuit and prevent damage to system components.
- When washing the vehicle
 - Self car wash
 - Keep the door locked with the outside door handle closed.
 - To keep the door unlocked, push back the outside door handle by hand. This function prevents the door handle from being damaged, and the door handle pops out again when the unlock button is pressed.
 - Auto car wash
 - Keep the door locked with the outside door handle closed.
 - If the Smart Key is not in the vehicle, turn off the vehicle and stay the Smart Key away at least 2 m (78 in.) from the vehicle to prevent the outside door handle operates.

Mechanical key

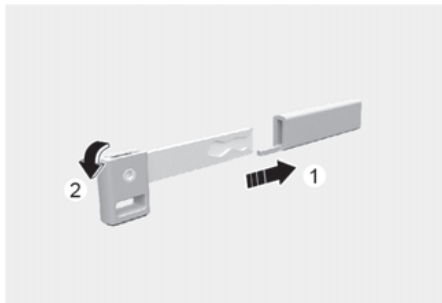

Turn the knob (2) of the mechanical key after removing the key protector (1). Press the front part (3) of the door handle to pull out the rear part of the door handle. While keep pressing the front part of the door handle, insert the mechanical key (4) to the lock.

To lock the door, turn the key toward the front (left side) of the vehicle. To unlock, turn the key toward the rear (right side) of the vehicle.

NOTICE

Do not apply excessive force on the door and door handle. It may damage the door and door handle.

The mechanical key only locks/unlocks the driver's door handle. For more information, refer to the "In case of an emergency" section in this chapter.

i Information

When the door handle or the keyhole freeze and do not open, lightly tap or indirectly warm (for example, hand temperature) the keyhole.

Operating door lock/unlock from inside the vehicle

With the door handle

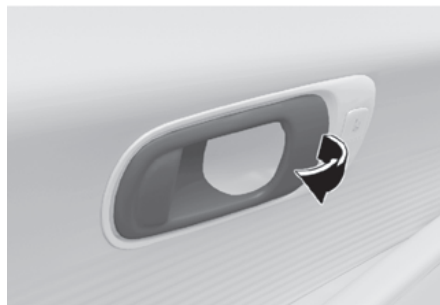

Front door

If the inner door handle is pulled when the door is locked, the door will unlock and open.

Rear door

If the inner door handle is pulled once when the door is locked, the door will unlock. If the inner door handle is pulled once more, the door will open.



i Information

If a power door lock ever fails to function while you are in the vehicle try one or more of the following techniques to exit:

- Operate the door unlock feature repeatedly (both electronic and manual) while simultaneously pulling on the door handle.
 - Operate the other door locks and handles, front and rear.
 - Lower a front window and use the mechanical key to unlock the door from outside.
-

With the central door lock switch



The central door lock switch is located on the center console. The lock switch is indicated by a  symbol. The unlock switch is indicated by a .

When the lock switch (1) is pressed, all the vehicle doors will lock.

When the unlock switch (2) is pressed (door indicator light ON), all the vehicle doors will unlock.

If the smart key is in the vehicle and any door is open, the doors will not lock even though the lock switch (1) is pressed.

NOTICE

If the smart key is in the vehicle and the front door is opened, the central door lock button (1) cannot lock the doors.

In case of an emergency

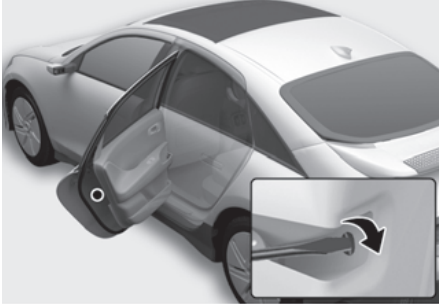

In case of emergency such as when the battery is discharged, the only way to lock the door(s) is with the mechanical key from the outside key hole.

Doors without an outside key hole can be locked as follows:

1. Open the door.
2. Insert a small blade tool (for example, screwdriver or similar) into the emergency door lock hole and turn it clockwise for left side door, or turn it counterclockwise for right side door.
3. Close the door securely.

i Information

If the electrical power door lock switch does not operate (for example, dead car battery) and the trunk is closed, you will not be able to open the trunk until power is restored.

WARNING

- The doors should always be fully closed and locked while the vehicle is in motion. If the doors are unlocked, the risk of being thrown from the vehicle in a crash is increased.
- Do not pull the inner door handle of the driver's or passenger's door while the vehicle is moving.

WARNING

Do not leave the elderly, children or animals unattended in your vehicle. An enclosed vehicle can become extremely hot, causing death or serious injury to the elderly, unattended children or animals who cannot escape from the vehicle. Children might operate features of the vehicle that could injure them, or they could encounter other harm, possibly from someone gaining entry to the vehicle.

WARNING

Always secure your vehicle.

Leaving your vehicle unlocked increases the potential risk to you or others from someone hiding in your vehicle.

To secure your vehicle, while depressing the brake, shift the gear to the P (Park) position, engage the parking brake, and press the Start/Stop button to the OFF position, close all windows, lock all doors, and always take the key with you.

CAUTION

Opening a door when something is approaching may cause damage or injury. Be careful when opening doors and watch for vehicles, motorcycles, bicycles or pedestrians approaching the vehicle in the path of the door.

WARNING

If you stay in the vehicle for a long time while the weather is very hot or cold, there are risks of injuries or danger to life. Do not lock the vehicle from the outside when someone is in the vehicle.

Deadlocks

 If equipped

Some vehicles are equipped with a deadlock system. Deadlocks prevent opening of a door from either inside or outside the vehicle once the deadlocks have been activated providing an additional measure of vehicle security.

To lock the vehicle using the deadlock function, the doors must be locked by using the smart key. To unlock the vehicle, the smart key must be used again.

Automatic door lock and unlock features

Your vehicle is equipped with features that will automatically lock or unlock your vehicle based on settings you select in the infotainment system.

Auto Lock Enable on speed

When this feature is set in the infotainment system, all the doors will be locked automatically when the vehicle exceeds 15 km/h (9 mph).

Auto Unlock Enable at Vehicle Off

When this feature is set in the infotainment system, all the doors will be unlocked automatically when the vehicle is turned off.

For more information, refer to the separately supplied infotainment system manual.

Additional unlock safety feature airbag deployment

As an additional safety feature, all doors will be automatically unlocked when an impact causes the airbags to deploy.

Child-protector rear door locks

 if equipped

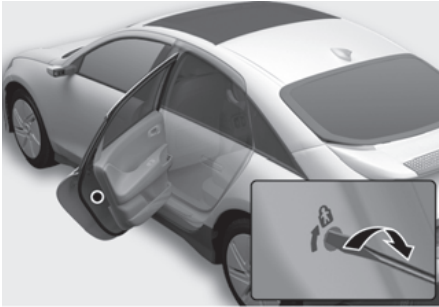

The child safety lock is provided to help prevent children seated in the rear from accidentally opening the rear doors. The rear door safety locks should be used whenever children are in the vehicle.

The child safety lock is located on the edge of each rear door. When the child safety lock is in the lock position, the rear door will not open if the inner door handle is pulled.

To lock the child safety lock, insert a small flat blade tool (for example, screwdriver or similar) into the slot and turn it to the lock position as shown.

To allow a rear door to be opened from inside the vehicle, unlock the child safety lock.

WARNING

If children accidentally open the rear doors while the vehicle is in motion, they could fall out of the vehicle. The rear door safety locks should always be used whenever children are in the vehicle.

Theft-alarm system

This system helps to protect your vehicle and valuables. The horn will sound and the hazard warning lights will blink continuously if any of the following occur:

- A door is opened without using the smart key.
- The trunk is opened without using the smart key.
- The vehicle hood is opened.

The alarm continues for 30 seconds, then the system resets. To turn off the alarm, unlock the doors with the smart key.

The Theft Alarm System automatically sets 30 seconds after you lock the doors and the trunk. For the system to activate, you must lock the doors and the trunk from outside the vehicle with the smart key or by touching the touch sensor or pressing the button on the outside door handle with the smart key in your possession.

The hazard warning lights will blink and the chime will sound once to indicate the system is armed.

Once the security system is set, opening any door, the trunk, or the hood without using the smart key will cause the alarm to activate.

The Theft Alarm System will not set if the hood, the trunk, or any door is not fully closed. If the system will not set, check the hood, the trunk, or the doors are fully closed.

Do not attempt to alter this system or add other devices to it.

i Information

- Do not lock the doors until all passengers have left the vehicle. If the remaining passenger leaves the vehicle when the system is armed, the alarm will be activated.
 - If the vehicle is not disarmed with the smart key, open the doors by using the mechanical key and start the vehicle by directly pressing the Start/Stop button with the smart key.
 - If the system is disarmed by unlocking the vehicle, but neither a door or the trunk is opened within 30 seconds, the doors will relock and the system will reararm automatically.
-

i Information



Vehicles equipped with a theft alarm system will have a label attached to the vehicle with the following words:

1. WARNING
 2. SECURITY SYSTEM
-

Rear Occupant Alert (ROA)

+ If equipped

Rear Occupant Alert is provided to prevent a driver from leaving a vehicle with the rear passenger left in the vehicle.

System setting

To use Rear Occupant Alert, it must be enabled from the Settings menu in the infotainment system. Select:

- **Setup > Vehicle Settings > Convenience > Rear Occupant Alert**

i Information

The infotainment system may change after software updates. For more information, refer to the manual provided in the infotainment system and the quick reference guide.

System operation

- **First alert**
When you turn off the vehicle and open the driver's door after opening and closing the rear door or trunk, the **"Check rear seats for passengers and belongings"** warning message appears on the instrument cluster.
- **Second alert (if the sensor equipped)**
After the first alert, the second alert operates when any movement is detected in the vehicle after the driver's door is closed and all the doors are locked. The horn sounds about 25 seconds. If the system continues to detect a movement, the alert operates up to 8 times.
Unlock the doors with the smart key to stop the alert.
- The system detects movement in the vehicle for 10 minutes after the door is locked.

i Information

- The second alert is activated only after the prior activation of the first alert.
- Rear Occupant Alert also activates when movement is detected in the cargo area.
- The second alert activates only when the sensor is equipped in the vehicle.

System precautions

- Make sure that all the windows are closed. If the window is open, the alert may operate by the sensor detecting an unintended movement (for example, wind or bugs).

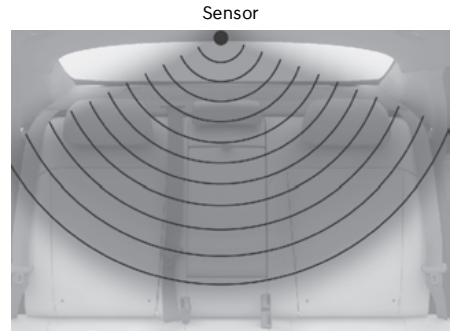

- If you do not want to use the second alert of Rear Occupant Alert, press the **'OK'** button on the steering wheel until when the first alert is displayed on the instrument cluster. Doing so will deactivate the second alert one time.

Instrument cluster

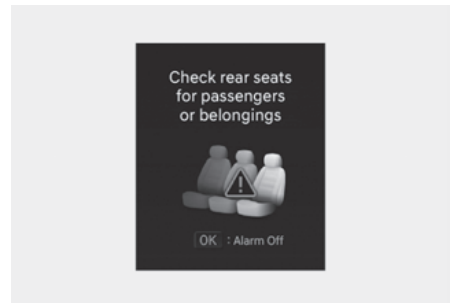

Steering wheel

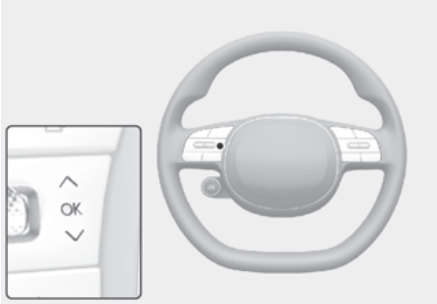

- If the vehicle is started remotely (if equipped with Remote Start), inside movement detection will stop.
- The alert may operate if movement in the driver or passenger seat is detected.
- If the doors are locked with a passenger inside the vehicle, the alert may operate.
- An alert can occur if there is an impact on the vehicle.
- If boxes or objects are stacked in the vehicle, the system may not detect the boxes or objects. Or, the alert may operate if the boxes or objects fall off.
- The alert may operate if movement in the driver or passenger seat is detected.
- The alert may operate with the doors locked due to car wash or surrounding vibration or noise.
- The alert may operate when there are metallic or liquid objects in the vehicle.

WARNING

Even if your vehicle is equipped with Rear Occupant Alert (ROA), always make sure to check the rear seat before you leave the vehicle.

Rear Occupant Alert (ROA) may not operate when:

- Movement does not continue for a certain period of time or the movement is small.
 - A child is not seated in a child restraint system.
 - The detection signal is weak because the signal is obscured by seat or CRS (for example, child is restrained in the forward-facing CRS).
 - Movement is detected in areas other than the rear seats.
 - The rear passenger is a child over 6 years.
 - The rear passenger is covered with a fabric containing metallic substance such as a blanket.
 - An object in the vehicle blocks the sensor.
 - The sensor is contaminated by foreign material.
 - An animal at the rear seat is not large enough to be detected by the sensor or there is hardly any movement.
 - Attaching objects or modifying the interior ceiling, or the interior ceiling is deformed or damaged.
 - There are electronic interference around the vehicle.
 - Other environmental reasons that may affect the system.
-

Declaration of conformity

The radio frequency components (ROA Radar Sensor) complies:

- For Europe and CE certified countries



Integrated memory system



Integrated Memory System for the driver's seat is provided to store and recall the following memory settings with a simple button operation.

- Driver's seat position
- Outside rearview mirror position
- Head-Up Display (HUD) position

WARNING

Never attempt to operate the integrated memory system while the vehicle is moving.

This could result in loss of control, and an accident causing death, serious injury, or property damage.

Information

- If the battery is disconnected, the memory settings will be erased.
- If integrated memory system does not operate normally, we recommend that you have the system inspected by an authorized HYUNDAI dealer.

Storing memory positions

1. Shift to P (Park) while the Start/Stop button is in the ON position.
2. Adjust the driver's seat position, outside rearview mirror position, and head-up display height to the desired position.
3. Hold the button (1 or 2). The system will beep once and notify you 'Driver 1 (or 2) settings saved' will appear on the infotainment screen.

Recalling memory positions

1. Shift to P (Park) while the Start/Stop button is in the ON position.
2. Press the desired memory button (1 or 2). The system will beep once, and then the driver's seat position, outside rearview mirror position, and head-up display height will automatically adjust to the stored positions.
3. 'Driver 1 (or 2) settings applied' will appear on the infotainment screen.

i Information

- In order to adjust the memory button (2) while adjusting the memory button (1), press the memory button (1) to pause the adjustment of (1), then press memory button (2).
 - If you adjust the seat, outside rearview mirror, head-up display while recalling the stored positions, the manually adjusted settings will be applied.
-

Resetting the system

Take the following procedures to reset integrated memory system, when it does not operate properly.

Resetting integrated memory system

1. Stop the vehicle and open the driver's door with the Start/Stop button in the ON position and the vehicle shifted to P (Park).
2. Adjust the driver's seat and seatback to the foremost position.
3. Press the memory button 1 and push forward the driver's seat switch simultaneously (about two seconds).
4. Release the memory button and the driver's seat switch when a beep sounds.

While resetting integrated memory system

1. Resetting starts with a notification sound.
2. The driver's seat and seatback is adjusted to the rearward position with the notification sound.
3. The driver's seat and seatback is re-adjusted to the default position (central position) with the notification sound.

However, in the following cases, the resetting procedure and the notification sound may stop.

- The memory button is pressed.
- The seat control switch is operated.
- The gear is shifted out of P (Park).
- The driving speed exceeds 3 km/h (2 mph).
- The driver's door is closed.

NOTICE

- While integrated memory system is being reset, if the resetting and notification sound stops incompletely, restart the resetting procedure again.
- Make sure that there is no objects around the driver's seat in advance of resetting the integrated memory system.
- After resetting the integrated memory system, the adjustment for the driver seat must be stored again to recall the memory position.

Seat easy access

Seat easy access will move the driver's seat and steering wheel automatically as follows:

- Exiting the vehicle:

The driver's seat will move as follows when the Start/Stop button is in the OFF position with the gear in P (Park) and the driver's door open.

- Driver seat: Moves rearward depending on the distance selected from the Settings menu in the infotainment system.

However, the driver's seat may not move rearward if there is not enough space between the driver's seat and the rear seats.

- Entering the vehicle:

The driver's seat will move as follows when the Start/Stop button is pressed to the ACC, ON or START position or while carrying the smart key, the driver's door is closed with the Start/Stop button in the OFF position.

- Driver seat: Moves back to its original position.
- You can set the '**Seat Easy Access**' function from the Settings menu in the infotainment system. Select:
 - Driver seat

Setup > Vehicle Settings > Seat > Seating Easy Access > Driver Seat Easy Access > Extended/Normal/Off

i Information

The infotainment system may change after software updates. For more information, refer to the manual provided in the infotainment system and the quick reference guide.

Steering wheel

Motor Driven Power Steering (MDPS)

The system assists you with steering the vehicle. If the vehicle is turned off or if the power steering system becomes inoperative, you may still steer the vehicle, but it will require increased steering effort.

Should you notice any change in the effort required to steer during normal vehicle operation, we recommend that you have the system checked by an authorized HYUNDAI dealer.

CAUTION

If Electric Power Steering does not operate normally, the  warning light and the message '**Check motor driven power steering**' will illuminate on the instrument cluster. You may steer the vehicle, but it will require increased steering efforts. We recommend that you take the vehicle to an authorized HYUNDAI dealer and have the system checked as soon as possible.

Information

The following symptoms may occur during normal vehicle operation:

- The steering effort may be high immediately after pressing the Start/Stop button to the ON position. This happens as the system performs the MDPS system diagnostics. When the diagnostics are completed, the steering wheel effort will return to its normal condition.
 - When the 12 V battery voltage is low, you might have to put more steering effort. However, it is a temporary condition so that it will return to normal condition after charging the battery.
 - A click noise may be heard from the MDPS relay after the Start/Stop button is in the ON or OFF position.
 - Motor noise may be heard when the vehicle is at a stop or at a low driving speed.
 - When you operate the steering wheel in low temperatures, abnormal noise may occur. If the temperature rises, the noise will disappear. This is a normal condition.
 - When an error is detected from MDPS, the steering effort assist function will not be activated in order to prevent fatal accidents. Instrument cluster warning lights may be on or the steering effort may be high. If these symptoms occur, drive the vehicle to a safe area as soon as it is safe to do so. We recommend that you have the system checked by an authorized HYUNDAI dealer as soon as possible.
-

Tilt/Telescopic steering

When adjusting the steering wheel to a comfortable position, adjust the steering wheel so that it points toward your chest, not toward your face. Make sure you can see the instrument cluster warning lights and gauges. After adjusting, push the steering wheel both up and down to be certain it is locked in position.

Always adjust the position of the steering wheel before driving.

WARNING

NEVER adjust the steering wheel while driving. This may cause loss of vehicle control resulting in an accident.

NOTICE

While adjusting the steering wheel height, please do not push or pull it hard since the fixture can be damaged.

Manual adjustment

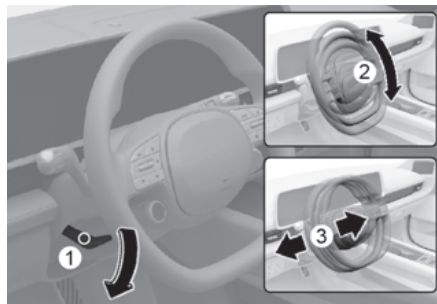

To adjust the steering wheel angle and height:

1. Pull down the lock-release lever (1).
2. Adjust the steering wheel to the desired angle (2) and distance forward/back (3).
3. Pull up the lock-release lever to lock the steering wheel in place.

i Information

Sometimes the lock release lever may not engage completely. This may occur when the gears of the locking mechanism do not completely mesh. If this occurs, pull down on the lock-release lever, readjust the steering wheel again, and then pull back up on the release lever to lock the steering wheel in place.

Horn



To sound the horn, press the area indicated by the horn symbol on your steering wheel (see illustration). The horn will operate only when this area is pressed.

NOTICE

Do not strike the horn severely to operate it, or hit it with your fist. Do not press on the horn with a sharp-pointed object.

Heated steering wheel

If equipped

Infotainment system

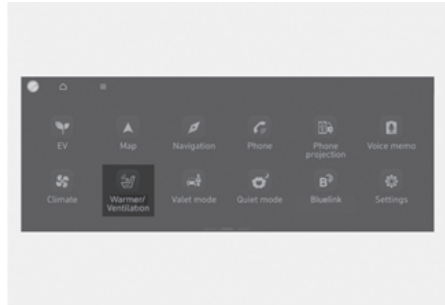

While the vehicle is running, touch Heating/Ventilation icon in the infotainment home screen.

Climate control panel

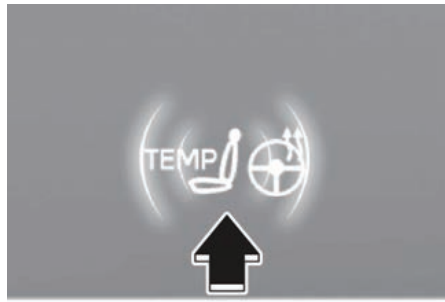

Press in the front climate control panel

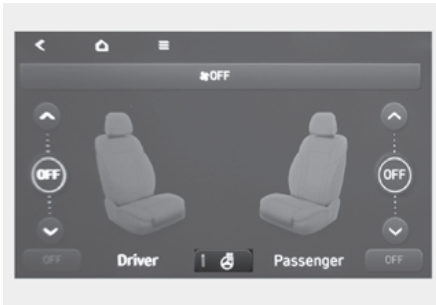

While the vehicle is running, touch the heated steering wheel icon to warm the steering wheel.

- To warm the steering wheel, touch the heated steering wheel icon in the Heating/Ventilation seats.
- Auto. Controls That Use Climate Control Settings (for driver's seat)
The heated steering wheel automatically controls the steering wheel temperature depending on the ambient temperature when the vehicle is running.

To use this function, it must be enabled from the Settings menu in the infotainment system.

Select:

- **Setup > Vehicle Settings > Seat > Warmer/Ventilation Features > Link to Climate Settings for Auto-Adjustment > Steering Wheel Warmer**

i Information

The infotainment system may change after software updates. For more information, refer to the manual provided in the infotainment system and the quick reference guide.

- The heated steering wheel defaults to the OFF position whenever the Start/Stop button is pressed to the ON position. However, if the Auto. Controls That Use Climate Control Settings function is ON, the heated steering wheel will turn on and off depending on the outside temperature.

NOTICE

Do not install any cover or accessory on the steering wheel. The cover or accessory could cause damage to the heated steering wheel system.

Mirrors

Inside rearview mirror

Before driving your vehicle, check to see that your inside rearview mirror is properly positioned. Adjust the rearview mirror so that the view through the rear window is properly centered.

WARNING

Make sure your line of sight is not obstructed. Do not place objects in the rear seat, cargo area, or behind the rear headrests which could interfere with your vision through the rear window.

WARNING

To prevent serious injury during an accident or deployment of the airbag, do not modify the rearview mirror and do not install a wide mirror.

WARNING

NEVER adjust the mirror while driving. This may cause loss of vehicle control resulting in an accident.

NOTICE

When cleaning the mirror, use a paper towel or similar material dampened with glass cleaner. Do not spray glass cleaner directly on the mirror as this may cause the liquid cleaner to enter the mirror housing.

Day/night rearview mirror

 If equipped



Make this adjustment before you start driving and while the day/night lever is in the day position.

Pull the day/night lever towards you to reduce glare from the headlights of the vehicles behind you during night driving.

Remember that you lose some rearview clarity in the night position.

Electric Chromic Mirror (ECM)

+ if equipped



[A] Indicator

Some vehicles come equipped with an electrochromic mirror that helps control glare while driving at night or under low light driving conditions.

When the vehicle is running, the glare is automatically controlled by the sensor mounted in the rearview mirror. The sensor detects the light level around the vehicle, and automatically adjusts to control the headlight glare from vehicles behind you.

Whenever the gear is shifted to R (Reverse), the mirror will automatically go to the brightest setting in order to improve the driver's view behind the vehicle.

Outside rearview mirrors

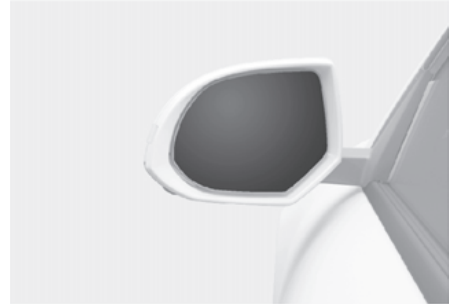

Your vehicle is equipped with both left-hand and right-hand outside rearview mirrors. The mirrors can be adjusted remotely with the mirror adjustment control switch. The outside rearview mirrors can be folded to help prevent damage when going through an automatic car wash or when passing through a narrow street.

The left and right outside rearview mirror is convex. Objects seen in the mirror are closer than they appear.

Use the inside rear view mirror or look back directly to determine the actual distance of other vehicles prior to changing lanes.

Make sure to adjust the outside rearview mirrors to your desired position before you begin driving.

⚠️ WARNING

Do not adjust or fold the outside rearview mirrors while driving. This may cause loss of vehicle control resulting in an accident.

NOTICE

- Do not scrape ice off the mirror face; this may damage the surface of the glass.
- If the mirror is jammed with ice, do not adjust the mirror by force. Use an approved de-icer (not radiator antifreeze) spray, or a sponge or soft cloth with very warm water, or move the vehicle to a warm place and allow the ice to melt.
- Do not clean the mirror with harsh abrasives, fuel or other petroleum based cleaning products.

Adjusting the rearview mirrors

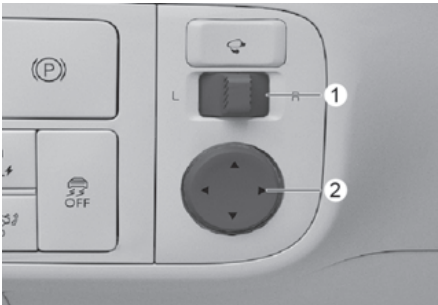

Adjusting the rearview mirrors:

1. When the Start/Stop button is in the ACC, ON or START position, move either the L (Left side) or R (Right side) button (1) to select the rearview mirror you would like to adjust.
2. Use the mirror adjustment control switch (2) to position the selected mirror up, down, left or right.
3. After adjustment, move the lever (1) to the middle to prevent inadvertent adjustment.

NOTICE

- The mirrors stop moving when they reach the maximum adjusting angles, but the motor continues to operate while the switch is pressed. Do not press the switch longer than necessary, because this can damage the motor.
- Do not attempt to adjust the rearview mirrors by hand, because this can damage the motor.

Folding the rearview mirrors

Folding button



The rearview mirrors can be folded or unfolded by pressing the button.

Infotainment system setting

- Enable on door unlock
If **Setup > Vehicle Settings > Lights > Welcome Mirror/Light > Enable on Door Unlock** is selected from the Settings menu in the infotainment system,
 - The mirror will fold or unfold when the door is locked or unlocked by the smart key.
 - The mirror will fold or unfold when the door is locked or unlocked by the touch sensor or button on the outside door handle.

- Enable on driver approach

If **Setup > Vehicle Settings > Lights > Welcome Mirror/Light > Enable on Driver Approach** is selected from the Settings menu in the infotainment system, the mirror will unfold when the vehicle is approached with the smart key in possession.

i Information

The infotainment system may change after software updates. For more information, refer to the manual provided in the infotainment system and the quick reference guide.

i Information

For your safety, the outside rearview mirrors cannot be folded automatically when driving at a speed of 15 km/h (9 mph) or faster.

NOTICE

The electric type outside rearview mirror operates even though the Start/Stop button is in the OFF position. However, to prevent unnecessary battery discharge, do not adjust the mirrors longer than necessary while the vehicle is not running.

NOTICE

Do not fold the electric type outside rearview mirror by hand. It could cause motor failure.

Reverse parking aid

 if equipped



When the gear is shifted to the R (Reverse) position, the outside rearview lever(s) will rotate downwards to aid with driving in reverse.

The state of the outside rearview mirror lever (1) determines whether or not the mirrors will move:

How it works

- Left/Right: When either the L (Left) or R (Right) lever is selected, both outside rearview mirrors will move.
- Neutral: When neither switch is selected, the outside rearview mirrors will not move.

The outside rearview mirrors will automatically revert to their original positions if any of the following occur:

- The Start/Stop button is pressed to either the OFF position or the ACC position.
- The gear is shifted to any position except R (Reverse).
- The outside rearview mirror adjustment button is not selected.

Reverse parking aid user settings mode

You may change the angle of the outside rearview mirror if it is difficult to see the rear view with the basic downward mirror angle provided when reversing.

When the vehicle is first delivered, the set downward angle of the left and right outside rearview mirror are different to ensure driver visibility.

1. Make sure the vehicle is stopped.
2. Depress the brake pedal and shift the gear to R (Reverse). When L (Left) or R (Right) lever is selected, both outside rearview mirror angle will move downward to the basic set position.
3. Move either L or R lever to select the outside rearview mirror you would like to adjust. Then press "▼, ▲, ◀, ▶" switch to adjust the outside rearview mirror to the desired angle.
4. After adjusting the angle to save the adjusted outside rearview mirror angle, shift the gear to another position other than R (Reverse), or change the L and R levers to the neutral position (L and R levers are not selected).
5. Set the other outside rearview mirror following the above procedure 1 to 4.

Resetting reverse parking aid user settings mode

To change the outside rearview mirror angle back to the basic angle, shift the gear to R (Reverse), and adjust the mirror angle higher than when the gear is in P (Park), N (Neutral) and D (Drive).

NOTICE

When changing the angle of both outside rearview mirrors, it is recommended to change the angle one side at a time following the procedure 1 to 4.

Digital side mirror (DSM)

 if equipped

DSM Camera



DSM Monitor

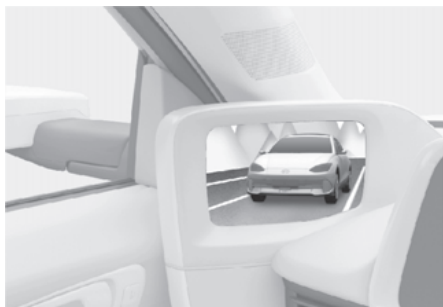

The digital side mirrors are a replacement for the outside rearview mirrors and help with changing lanes by displaying the rear view image on the monitors inside the vehicle.

Information

- The DSM monitor brightness is linked to the instrument cluster's brightness.
- The DSM camera angle is linked to the integrated memory system (IMS).

WARNING

Do not adjust or fold the DSM cameras while driving. It distracts you from driving and may cause an accident.

CAUTION

- The digital side mirrors show the rear view as an image, so the view may differ from the actual view and you cannot see the field of view out of the set position. Be careful while driving.
- The display of the DSM monitor may seem blur due to strong light sources such as direct sunlight and may temporarily be obscured by light bleed or headlights of the vehicle behind. Use the inside rearview mirror, etc. to see around the vehicle.
- In certain situations, an image error may occur, such as the DSM monitor being out of focus or displaying incorrect colors. This makes it difficult to clearly see moving objects and causes your eyes to feel tired due to watching the monitor for a long time.
- Always pay attention to the condition of your vehicle while driving. If you think there is an error in the vehicle, immediately park in a safe place and contact an authorized HYUNDAI dealer.
- If the DSM monitor display is not clear, the monitor lenses may be contaminated or foggy. Wipe the DSM camera lenses or activate the defroster to remove fog or foreign substances before driving. Be careful not to damage the lens while wiping, and be careful not to get burned by the operation of the defroster.

Operating the digital side mirrors

Turning on the DSM monitors



When you unlock the doors or start the vehicle remotely, the digital side mirrors will prepare for operation. When you open a door or unfold the DSM cameras, the DSM monitors will turn on.

Turning off the DSM monitors

- When you stop the vehicle and lock the doors, or seven minutes after stopping the vehicle, the DSM monitors will automatically turn off and the DSM cameras will fold.
- If you fold the DSM cameras while the vehicle is on, the DSM monitors will display a black screen and notify you that the digital side mirrors are folded.
- The DSM monitors are automatically turned on or off based on various conditions, such as the vehicle and door status.

DSM warnings and indicators

The warnings and indicators displayed on the DSM monitors are as follows.

	Explanation
	Driving assistance warning <ul style="list-style-type: none"> • Blind-Spot Collision-Avoidance Assist (BCA) • Safe Exit Warning (SEW) • Rear Cross-Traffic Collision-Avoidance Assist (RCCA)
	DSM check indicator
	Wide view mode switch indicator

Displaying the guidelines

When you turn on the turn signal indicator to change lanes, the rearview screen and the lane change guidelines will be displayed on the DSM monitors.

- Red: 3 m away from the rear of the vehicle
- Orange: 12 m away from the rear of the vehicle

Setting the feature

1. On the infotainment system, press **Setup > Vehicle Settings > Convenience > Digital Side Mirror**.
2. Select **Lane change assistance guideline** to activate or deactivate the feature.

i Information

The infotainment system may change after software updates. For more information, refer to the manual provided in the infotainment system and the quick reference guide.

Guideline display conditions

The turn signal indicator is turned on.

Guideline removal conditions

- The vehicle is turned off.
- The Turn signal indicator is turned off.
- The Hazard warning light is turned on.

! CAUTION

- The lane change guidelines may differ from the actual situation depending on your vehicle and the road conditions.
- To change lanes, turn on the turn signal indicator in advance and secure enough space in the lane before entering.

Adjusting the DSM cameras

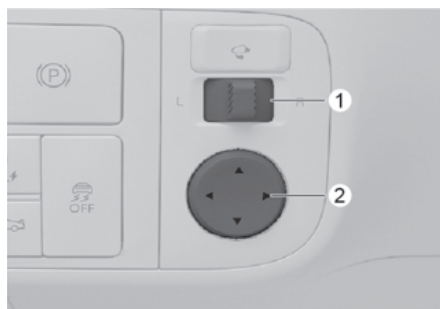

1. With Start/Stop button in the ACC, ON or START position, move the DSM camera selection lever (1) to select L (Left) or R (Right).
2. Use the DSM camera adjustment switch (2) to adjust the camera angle.

NOTICE

Do not adjust the DSM cameras manually. Adjusting the DSM cameras manually may damage the related parts.

Folding/Unfolding the DSM cameras

DSM camera folding button



To fold or unfold the DSM cameras, press the DSM camera folding button.

Enable on door unlock (infotainment system)

If you select **Setup > Vehicle Settings > Lights > Welcome Mirror/Light > Enable on Door Unlock** on the infotainment system,

- The DSM cameras will fold when locking the doors.
 - By pressing the door lock button (🔒) on the smart key
 - By touching the door lock/unlock sensor on the front outside door handles (the engraved part)
- The DSM cameras will unfold when unlocking the doors.
 - By pressing the door unlock button (🔓) on the smart key
 - By touching the door lock/unlock sensor on the front outside door handles (the engraved part)

When '**Enable on Door Unlock**' is selected, you can select '**Enable on Driver Approach**'. If you select '**Enable on Driver Approach**', the DSM cameras will unfold when you approach the vehicle with the smart key.

i Information

The infotainment system may change after software updates. For more information, refer to the manual provided in the infotainment system and the quick reference guide.

i Information

For your safety, the DSM cameras cannot be folded when driving at a speed of 15 km/h (9 mph) or faster.

NOTICE

- You can control the DSM cameras when the Start/Stop button is in the OFF position, but excessive control may discharge the vehicle's battery.
- Always use the DSM camera folding button to fold or unfold the DSM cameras. Folding or unfolding the cameras manually may damage the motor. Also, vibrations or noises may be emitted from the DSM cameras while driving, indicating that the gears are not engaged correctly. In this case, engage the gears by folding and unfolding the camera again using the folding button.

- When cleaning the DSM camera lenses or the DSM monitors, do not spray the cleaner directly. Instead, coat it on a soft towel or cloth. If you spray the cleaner directly on the lenses or monitors, the cleaner may get inside, causing a malfunction.
- Do not scrape ice off the surface of the DSM camera lenses. Doing so may damage the lenses.
- Do not use warm or hot water to remove snow or ice from the camera lenses. Doing so may cause cracks in the lenses.
- If the DSM camera is jammed with ice, do not adjust the camera by force. Use an approved de-icer spray, or move the vehicle to a warm place and allow the ice to melt.

Switching to wide view when backing up



i Information

- The guidelines displayed on the DSM monitors while backing up indicate the following points.
 - 0.3 m (11 in.) away from the side of the vehicle
 - 0.5 m (11 in.) and 1 m (39 in.) away from the rear of the vehicle
- The wide view will be deactivated when you shift to N (Neutral) or D (Drive) and drive at a speed of 10 km/h (6 mph) or faster.
- The wide view appears only when the wide view switch feature is activated while backing up. In P (Park), N (Neutral), and D (Drive), the DSM monitors display the original view.

Setting wide view operation



Use the DSM camera selection lever (1) to select L (Left) or R (Right).

- When you shift to R (Reverse), the DSM monitors will display wide view.
- If you put the DSM camera selection lever (1) in the center, the DSM monitors will not display wide view.

CAUTION

If there is an error in the digital side mirror, the DSM monitors will not display the rear view and a warning message informing you to check the DSM system will appear on the instrument cluster. If this occurs, check the surroundings using the inside rearview mirror and immediately park your vehicle at a safe place, and we recommend you contact an authorized HYUNDAI dealer.

Setting the DSM screen brightness

With the Start/Stop button in the ON position, on the infotainment system, select **Setup > Display > Screen Brightness** to change the brightness.

- Automatic Brightness or Manual Brightness adjustment (if equipped with rain sensor)
- Screen Brightness (Day/Night) setting (if the rain sensor is not equipped)

Information

The infotainment system may change after software updates. For more information, refer to the manual provided in the infotainment system and the quick reference guide.

DSM camera defroster

To turn on the defroster manually, turn on the wiper or rear window defroster. The feature will be activated for a certain time

Windows

Left Hand Drive

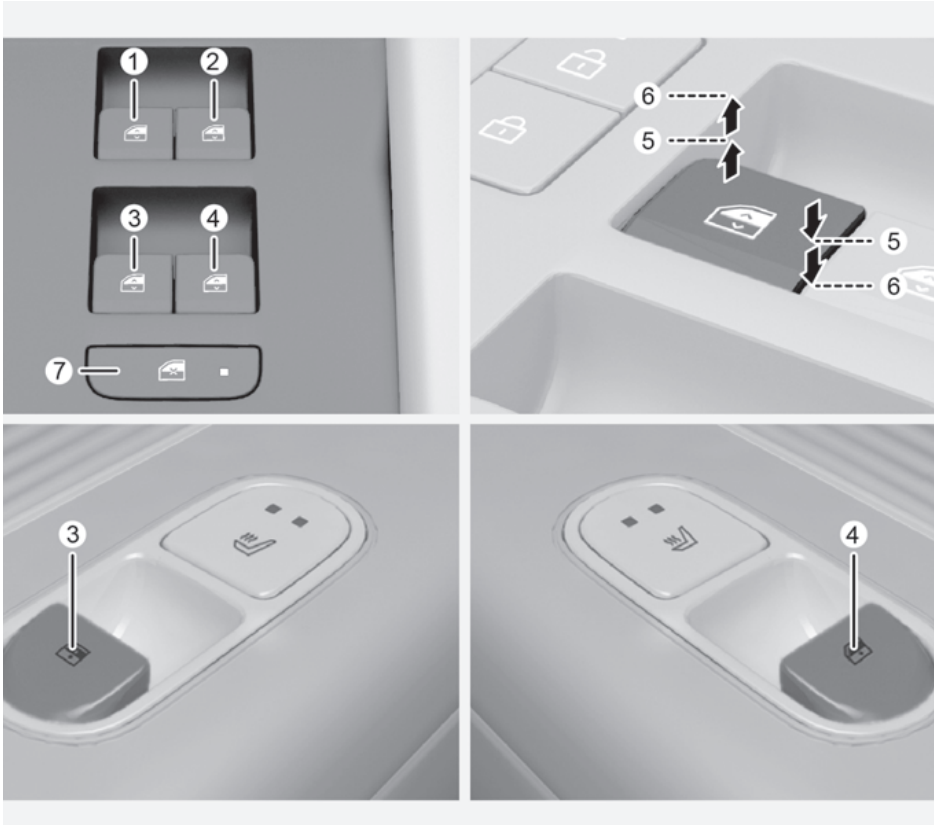

- (1) Driver's door power window switch
- (2) Front passenger's door power window switch
- (3) Rear door (left) power window switch
- (4) Rear door (right) power window switch
- (5) Window opening and closing
- (6) Automatic power window
- (7) Power window lock switch

Right Hand Drive

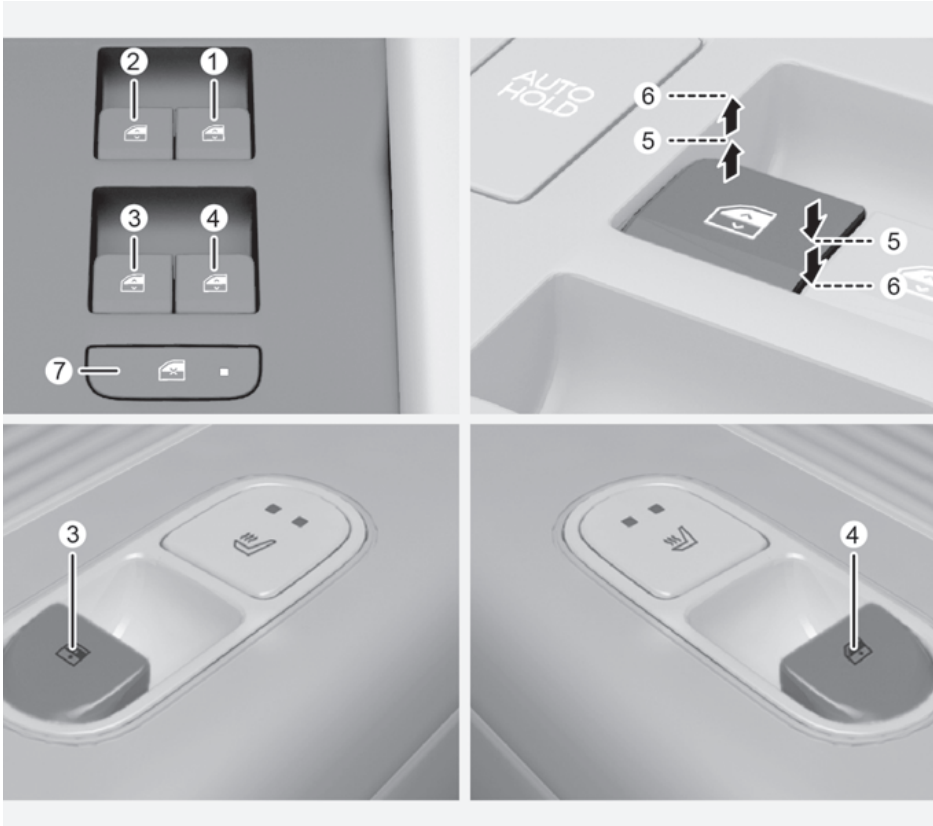

- (1) Driver's door power window switch
- (2) Front passenger's door power window switch
- (3) Rear door (left) power window switch
- (4) Rear door (right) power window switch
- (5) Window opening and closing
- (6) Automatic power window
- (7) Power window lock switch

Power windows

The Start/Stop button must be in the ON position to be able to raise or lower the windows. The front door window power window switch is located on the center console along with the power window lock button which can block the operation of rear passenger windows. The power window switch for the rear door windows are on the rear doors. The power windows will operate for about 3 minutes after the Start/Stop button is in the ACC or OFF position. However, if the front doors are opened, the power windows will not operate even within the 3 minute period.

Window opening and closing

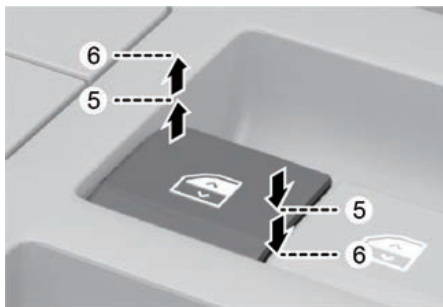

To open:

Press the window switch down to the first detent position (5). Release the switch when you want the window to stop.

To close:

Pull the window switch up to the first detent position (5). Release the window switch when you want the window to stop.

Auto up/down window

Pressing the power window switch momentarily to the second detent position (6) completely lowers or lifts the window even when the switch is released. To stop the window at the desired position while the window is in operation, pull up or press down and release the switch.

WARNING

- Do not leave the vehicle running and the key in your vehicle with unsupervised children. Unattended children could operate the window, which could result in serious injury.
- Do not extend your head, arms or any other body parts or objects outside the window while driving to avoid serious injury.

Resetting the power windows

If the power windows do not operate normally, the automatic power window system must be reset as follows:

1. Press the Start/Stop button to the ON position.
2. Close the window and continue pulling up on the power window switch for at least one second.

If the power windows do not operate properly after resetting, we recommend that the system be inspected by an authorized HYUNDAI dealer.

WARNING

The automatic reverse feature doesn't activate while resetting the power window system. Make sure body parts or other objects are safely out of the way before closing the windows to avoid injuries or vehicle damage.

Automatic reverse

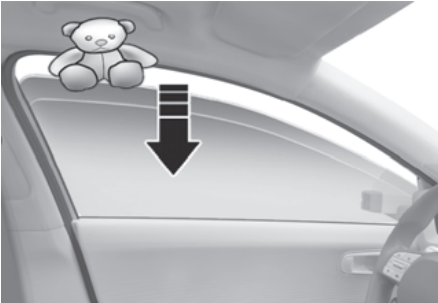

If a window senses any obstacle while it is closing automatically, it will stop and lower about 30 cm (12 in.) to allow the object to be cleared.

If the window detects the resistance while the power window switch is pulled up continuously, the window will stop upward movement then lower about 2.5 cm (1 in.).

If the power window switch is pulled up continuously again within 5 seconds after the window is lowered by the automatic window reverse feature, the automatic window reverse will not operate.

i Information

The automatic reverse feature is only active when the "Auto Up" feature is used by fully pulling up the switch to the second detent.

! WARNING

Make sure body parts or other objects are safely out of the way before closing the windows to avoid injuries or vehicle damage.

Objects less than 4 mm (0.16 in.) in diameter caught between the window glass and the upper window channel may not be detected by the automatic reverse window and the window will not stop and reverse direction.

Power window lock button

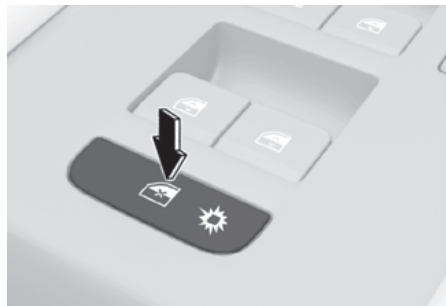

The driver can disable the power window switches on the rear passenger doors by pressing the power window lock button. When the power window lock button is pressed:

- The rear passenger control will not be able to operate the rear passenger power window.
- Note that the front passenger control is still able to operate the front passenger window, and that the driver master control can still operate all the power windows.

⚠ WARNING

Do not allow children to play with the power windows. Keep the driver's door power window lock button in the LOCK position. Serious injury or death can result from unintentional window operation by a child.

NOTICE

- To prevent possible damage to the power window system, do not open or close two windows or more at the same time. This will also ensure the longevity of the fuse.
- Never try to operate the main switch on the driver's door and the individual door window switch in opposite directions at the same time. If this is done, the window will stop and cannot be opened or closed.

Remote window opening/closing function

+ if equipped

Type A

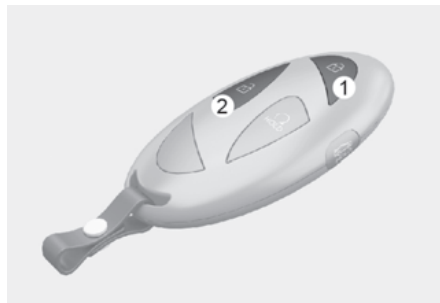

Type B



You can still control the window movement with the vehicle turned off by pressing the Door Lock button (1) or the Door Unlock button (2).

- Press the door lock button for more than 3 seconds. The doors will lock and the windows will move up as long as you press the door lock button.
- Press the door unlock button for more than 3 seconds. The doors will unlock and the windows will move down as long as you press the door unlock button.

i Information

- The remote window opening/closing function will be operated only with the Safety Power Windows equipped.
- The remote window opening/closing function may abruptly stop when you move away from your vehicle during operation. Stay in close proximity from your vehicle, while monitoring the window movement.
- One of the windows may stop operating when the window is interrupted by certain force. However, the other windows will keep operating. Make sure that all windows are closed.
- Please be aware that the doors unlock when the windows are opened using the remote window open/closing function.

⚠ WARNING

Always double check to make sure arms, hands, head and other obstructions are safely out of the way before using remote window closing function.

Wide sunroof

+ if equipped

If your vehicle is equipped with a sunroof, you can slide or tilt your sunroof with the sunroof switch located on the overhead console.



The sunroof can only be operated when the Start/Stop button is in the ON or START position.

The sunroof can be operated for about 3 minutes after the Start/Stop button is in the ACC or OFF position. However, if the front door is open, the sunroof cannot be operated even within the 3 minute period.

⚠ WARNING

- Adjust the sunroof or sunshade when your vehicle stops. This could result in loss of control and an accident that may cause injury, or property damage.
- Do not leave the vehicle running and the key in your vehicle with unsupervised children. Unattended children could operate the sunroof, which could result in serious injury.
- Do not sit on the top of the vehicle. It may cause injury or vehicle damage.

NOTICE

Do not operate the sunroof when roof bars are installed on the vehicle or when there is luggage on the roof.

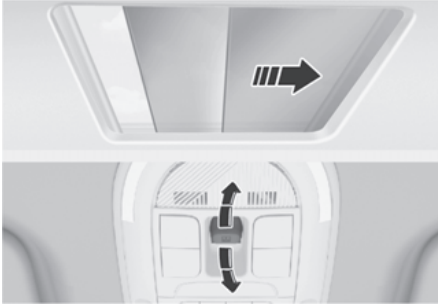
Power sunshade

Use the power sunshade to block direct sunlight coming through the sunroof glass.

- Push the sunroof switch rearward to the first detent position, the power sunshade automatically slides open.
- Push the sunroof switch forward to the first detent position, the power sunshade automatically closes. However, if the sunroof glass is open, the glass will close first.

To stop the power sunshade at any point, push the sunroof switch in any direction.

NOTICE

Do not pull or push the power sunshade by hand as such action may damage the power sunshade or cause it to malfunction.

i Information

Wrinkles formed on the power sunshade are normal due to material characteristic.

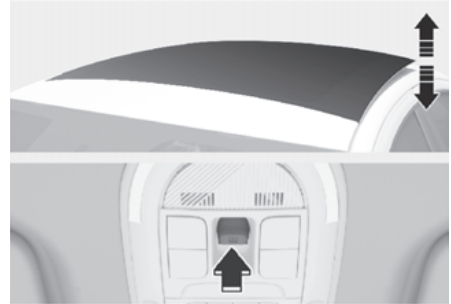
Tilt open/close

- Push the sunroof switch upward, the sunroof glass tilts open. However, if the power sunshade is closed, the sunshade will open first.
- Push the sunroof switch upward or forward when the sunroof glass is tilt opened, the sunroof glass automatically closes.

To stop the sunroof movement at any point, push the sunroof switch in any direction.

Slide open/close

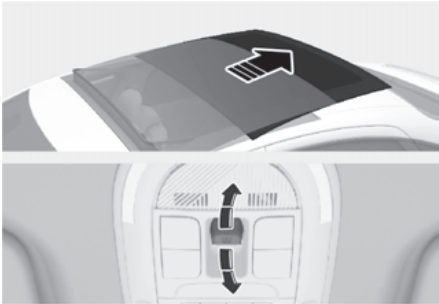

- Push the sunroof switch rearward to the first detent position, the sunroof glass opens. However, if the power sunshade is closed, the power sunshade will open first.

Push the sunroof switch forward to the first detent position, the sunroof glass closes. However, if the sunroof glass is closed, the power sunshade will close.

- Push the sunroof switch forward or rearward to the second detent position, the power sunshade and sunroof glass operate automatically (auto slide feature). To stop the sunroof movement at any point, push the sunroof switch in any direction.

Automatic reversal



If the power sunshade or sunroof glass senses any obstacle while it is closing automatically, it will reverse direction then stop at a certain position.

The auto reverse function may not work if an object thin or soft is caught between the sliding power sunshade or sunroof glass and sunroof sash.

WARNING

- Make sure heads, hands, arms or any other body parts or objects are out of the way before operating the sunroof. Body parts or objects may get caught causing injuries or vehicle damage.
- Never deliberately use your body parts to test the automatic reversal function. The power sunshade or sunroof glass may reverse direction, but there is a risk of injury.

NOTICE

- Do not continue to push the sunroof switch after the sunroof is fully opened, closed, or tilted. Damage to the sunroof motor could occur.
- Continuous operations such as slide open/close, tilt open/close, etc. may cause the motor or sunroof system to malfunction.
- Regularly remove any accumulated dust on the sunroof rail.
- Dust accumulated between the sunroof and roof panel can make noise. Open the sunroof and remove dust regularly using a clean cloth.
- Do not try to open the sunroof when the temperature is below freezing or when the sunroof is covered with snow or ice. The sunroof may not work properly and may break if opened by force.
- Do not open or drive with the sunroof glass open immediately after rain or washing the vehicle. Water may wet the interior of the vehicle.
- Do not extend any luggage outside the sunroof while driving. Vehicle damage may occur if the vehicle suddenly stops.

⚠ WARNING

Do not extend your head, arms, body parts or objects outside the sunroof while driving. Injuries may occur if the vehicle suddenly stops.

Resetting the sunroof

In some circumstances resetting the sunroof operation may need to be performed. Some instances where resetting the sunroof may be required include:

- When the 12 V battery is either disconnected or discharged
- When the sunroof fuse is replaced
- If the sunroof one-touch AUTO OPEN/CLOSE operation is not functioning properly

Sunroof resetting procedure:

1. It is recommended to perform the reset procedure with the vehicle running. Start the vehicle in P (Park).
2. Make sure the power sunshade and sunroof glass are in the fully closed position. If the power sunshade and sunroof glass are open, push the switch forward until the power sunshade and sunroof glass are fully closed.
3. Release the switch when the power sunshade and sunroof glass are fully closed.
4. Push the switch forward until the power sunshade and sunroof glass move slightly. Then release the switch.

5. Once again push and hold the sunroof switch forward until the power sunshade and sunroof glass slide open and close. Do not release the switch until the operation is completed.

If you release the switch during operation, start the procedure again from step 2.

i Information

If the sunroof does not reset when the vehicle battery is disconnected or discharged, or the sunroof fuse is blown, the sunroof may not operate normally.

Sunroof open warning

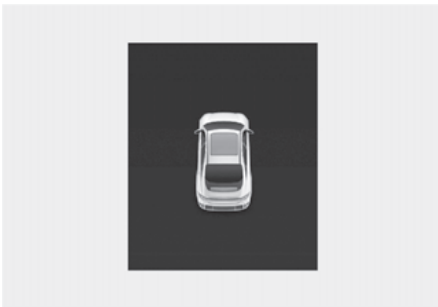

If the driver turns off the vehicle when the sunroof is not fully closed, the warning chime will sound for several seconds and the sunroof open warning will appear on the cluster display. Close the sunroof securely when leaving your vehicle.

⚠ CAUTION

Make sure the sunroof is closed fully when leaving your vehicle. If the sunroof is left open, rain or snow may wet the interior of the vehicle. Also, leaving the sunroof open when the vehicle is unattended may invite theft.

Hood

Opening the hood



1. Park the vehicle and apply the parking brake.
2. Pull the release lever to unlatch the hood. The hood pops open slightly.

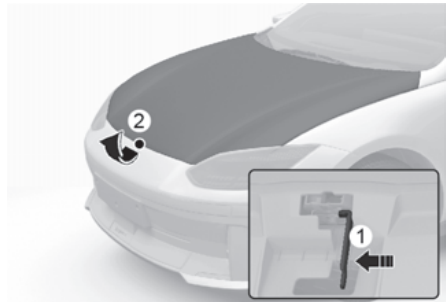

3. Go to the front of the vehicle, raise the hood slightly, push to the left the secondary hood release lever (1) inside of the hood center and lift the hood (2).

Closing the hood

1. Before closing the hood, check in and around the motor compartment to ensure the following:
 - Any tools or other loose objects have been removed.
 - All glove, rags, or other combustible material have been removed.
 - All filler caps are tightly and correctly installed
2. Lower the hood halfway (lifted about 30 cm (12 in.) from the closed position) and push down to securely lock in place. Then double check to be sure the hood is secure. If the hood can be raised slightly, it is not securely locked. Open it again and close it with more force.

WARNING

- Before closing the hood, ensure all obstructions are removed from around the hood opening. The hood will rise up or move down automatically if the height is not firmly adjusted. Be aware of the damage caused by the unintended hood movements.
- Always double check to make sure that the hood is firmly latched before driving away. Check there is no hood open warning light or message displayed on the instrument cluster. Driving with the hood open may cause a total loss of visibility, resulting in a collision.
- Do not move the vehicle with the hood raised. It may block your vision and may result in a collision.

Front trunk

Opening the hood reveals the front trunk and you can store your belongings.

Type A



Type B



Information

Available front trunk weight

- 2WD: 25 kg (55 lbs.)
- AWD: 10 kg (25 lbs.)

Available front trunk weight depends on the specifications.

WARNING

- NEVER make an attempt to get inside the front trunk. It will cause a fatal injury.
 - Before closing the hood, ensure all obstructions are removed from around the hood opening. The hood will rise up or move down automatically if the height is not firmly adjusted. Be aware of the damage caused by the unintended hood movements.
 - Never store cigarette lighters, propane cylinders, or other flammable/explosive materials in the vehicle. These items may catch fire and/or explode if the vehicle is exposed to hot temperatures for extended periods.
-

CAUTION

- Do not exceed the luggage volume capacity of the front trunk. The overweighted front trunk can be severely damaged.
 - Do not store the fragile objects in the front trunk.
 - ALWAYS keep the front trunk cover closed securely while driving. Items inside your vehicle are moving as fast as the vehicle. If you have to stop or turn quickly, or if there is a crash, the items can be damaged.
 - Do not spray water in the front trunk. Vehicle driving system may get damaged since the front trunk is located at the center of motor compartment.
 - Be careful when you store any liquid in the front trunk. If liquid leak outside the front trunk, it will cause a damage to the electric devices in the motor compartment.
-

NOTICE

To avoid possible theft, do not leave valuables in the storage compartments.

Power trunk

Power trunk operating conditions

The power trunk operates when vehicle speed is below 3 km/h (1.8 mph).

WARNING

- Never leave children or animals unattended in your vehicle. Children may operate the power trunk. Doing so can result in injury to themselves or others and can damage the vehicle.
 - Make sure there are no people or objects and enough space around the trunk before operating the power trunk or smart trunk prior to use. Serious injury, damage to the vehicle or damage to surrounding objects (for example, walls, ceilings, vehicles, etc.) may result if contact with the trunk occurs.
 - Make sure there are no people or objects around the trunk before operating the power trunk. Wait until the trunk is opened fully and stopped before loading or unloading cargo from the vehicle.
-

NOTICE

- Do not close or open the power trunk manually. This may cause damage to the power trunk. If it is necessary to close or open the power trunk manually when the battery is discharged or disconnected, do not apply excessive force.
 - Do not operate the power trunk more than 10 times continuously when the vehicle is turned off (**READY** indicator off). Use the power trunk with the vehicle turned on (**READY** indicator on) when the power trunk is used repeatedly to prevent battery discharge.
 - Do not leave the trunk open for a long period of time. This may drain the battery.
 - Do not modify or repair any part of the power trunk by yourself. We recommend that you contact an authorized HYUNDAI dealer.
 - Do not operate the power trunk under the following conditions. The power trunk may not operate properly.
 - One side of the vehicle is lifted to inspect the vehicle or change a tire
 - Parking on an uneven road such as a slope, etc.
 - Close the trunk completely and lock all doors and trunk using the central door lock button before using an automatic car wash.
 - Do not spray high pressure water directly on the power trunk outside open/close button. The trunk may open unintentionally.
-

i Information

- In cold and wet climates, the outside power trunk open button may not work properly due to freezing conditions. If this occurs, remove the ice before using the outside power trunk open/close button or use the power trunk open/close button on the Smart key or the instrument panel.
- If you leave the Smart key in the trunk and close the trunk, a warning will sound for about 5 seconds. If this occurs, open the trunk by pressing the power trunk open button on the outside of the trunk.
- If there are obstacles such as snow on the trunk, the trunk may not open automatically. After removing the obstacle, try to open it again.
- Be careful where there is an incline, as the trunk lid may drop slightly when it is stopped before it fully opens.

Operating the power trunk

Power trunk open/close button (Smart key)



When the trunk is closed, press the power trunk open/close button for 1.5 seconds. The trunk will open with a warning sound.

While the trunk is opening, press the button to stop power trunk operation.

When the trunk is opened, press and hold the power trunk open/close button to close the trunk. If you release the button while the trunk is closing, power trunk operation will stop with a warning sound for 5 seconds.

Also, if the Smart key is not within operation range from the vehicle, trunk operation will stop with a warning sound for 5 seconds.

Power trunk open/close button (Instrument panel)

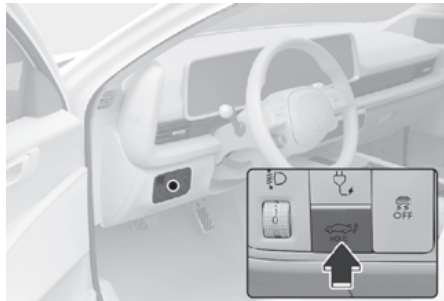

When the trunk is closed, press the power trunk open/close button. The power trunk will open with a warning sound.

While the trunk is opening, press the button to stop power trunk operation.

When the trunk is opened, press and hold the trunk open/close button to close the power trunk. If you release the button while the trunk is closing, power trunk operation will stop with a warning sound for 5 seconds.

Power trunk open button (Outside the power trunk)

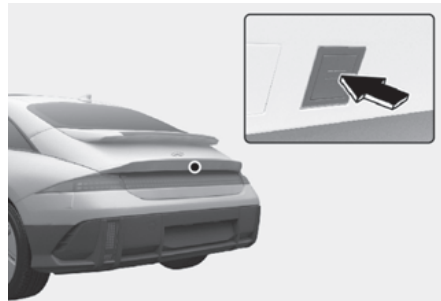

When the trunk is closed, press the power trunk open button to open the trunk.

If the vehicle is locked, press the power trunk open button with the Smart key in your possession.

While the trunk is opening, press the button to stop power trunk operation.

Power trunk close button (Inside the power trunk)



Press the power trunk close button. The trunk will close with a warning sound.

While the trunk is closing, press the button to stop power trunk operation.

Power trunk lock button (Inside the power trunk)

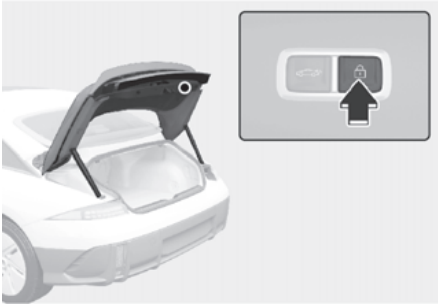

Press the power trunk lock button while carrying the Smart key. The power trunk will close and lock with a warning sound. Additionally, all doors will lock. The trunk will close and lock, and all doors will lock only when the vehicle is off or all doors are closed.

Switching the power trunk from manual to automatic

If you apply over a certain amount of power manually when the trunk is opened, the power trunk system detects the direction and closes or opens automatically.

- The power trunk fully opens when the trunk is raised.
- The power trunk closes completely when the trunk is lowered.

***i* Information**

The power trunk may not operate properly if the trunk is not opened above a certain height.

Automatic reverse

During power trunk operation if the power trunk senses any obstacle, the trunk will stop or will fully open. The automatic reverse feature may not operate properly, or it may operate unexpectedly under the following circumstances:

- The automatic reverse feature may not detect the resistance if the detected resistance is below a certain level, or if the trunk is almost fully closed near the latched position.
- The automatic reverse feature may operate if a strong impact is applied with no obstructions placed.

***!* WARNING**

Never intentionally place any object or part of your body in the path of the power trunk to make sure the automatic reverse feature operates. Serious injury, or damage to the vehicle or object may occur.

***i* Information**

The power trunk may stop operating if the automatic reverse feature operates more than two times while attempting to open or close the trunk. If this occurs, carefully open or close the trunk manually, and then after 30 seconds try to operate the power trunk automatically again.

Resetting the power trunk

To reset the power trunk:

1. With the vehicle is turned off or on (READY indicator off or on), put the gear in P (Park).
2. While Pressing the power trunk close inner button, press the power trunk open outer button for more than 3 seconds. A chime will sound.
3. Slowly close the trunk manually.
4. Press the power trunk open outer button. The trunk will open with a chime sound.

Wait until the trunk fully opens to complete resetting. If the trunk stops before it is fully open, resetting cannot be completed.

i Information

- If the power trunk is not reset after the vehicle battery is disconnected or discharged, or the power trunk fuse is blown, the power trunk may not operate normally.
- If the power trunk does not operate properly after the above procedure, we recommend that the system be inspected by an authorized HYUNDAI dealer.

Emergency trunk safety release

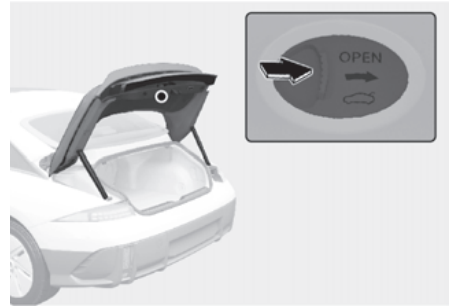

• Inside the trunk

Your vehicle is equipped with an emergency trunk safety release lever located inside the trunk. When someone is inadvertently locked in the trunk, the trunk can be opened by moving the lever in the direction of the arrow and pushing the trunk lid to open.

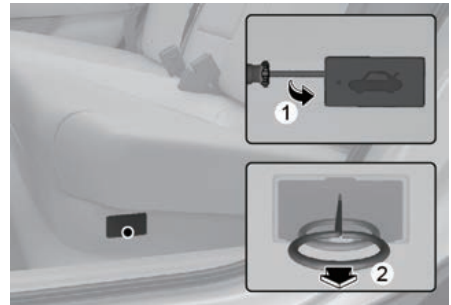

• Inside the vehicle

Follow the below procedure to open the power trunk manually when the battery is discharged or when there is a problem with the vehicle:

1. Remove the cable cover (1) under the rear seat using a small flat blade tool (like a screwdriver or similar).
2. Pull the cable loop (2) all the way out. The power trunk unlocks.
3. Push the trunk lid to open.

WARNING

- You and your passengers must be aware of the location of the Emergency Trunk Safety Release lever in this vehicle and how to open the trunk in case you are accidentally locked in the trunk.
 - NEVER allow anyone to occupy the trunk of the vehicle at any time.
 - Use the release lever for emergencies only.
-

NOTICE

Be careful not to scratch or lose the cover when removing it.

Information

The cable is firmly fixed so it may hard to pull. Therefore, please use a tool such as a screwdriver to assist in pulling the loop for the emergency release.

Smart trunk



On a vehicle equipped with a smart key, the trunk can be opened with hands-free activation using the smart trunk system.

Using smart trunk

The hands-free smart trunk system can be used when:

- The smart trunk option is enabled in the Settings menu in the infotainment system.
- The smart trunk is activated 15 seconds after all the doors are closed and locked.
- The smart trunk opens when the smart key is detected in the area behind the vehicle for 3 seconds.
- When disconnecting the charging connector, the smart trunk is activated.

i Information

The smart trunk does not operate when:

- A door is not locked or closed.
- The Smart key is detected within 15 seconds from when the doors were closed and locked.
- The Smart key is detected within 15 seconds after the doors are closed and locked, and within 1.5 m (60 in.) from the front door handles. (for vehicles equipped with Welcome Mirror).
- The Smart key is in the vehicle.
- The vehicle is on charge.

1. Settings

To use smart trunk, it must be enabled from the Settings menu in the infotainment system. Select:

- **Setup > Vehicle Settings > Door > Smart Trunk**

i Information

The infotainment system may change after software updates. For more information, refer to the manual provided in the infotainment system and the quick reference guide.

2. Detect and Alert

The smart trunk detecting area extends about 50-100 cm (20-40 in.) behind the vehicle. If you are positioned in the detecting area and are carrying the Smart key, the hazard warning lights blink and the chime sounds before opening.

i Information

If you unintentionally enter the detecting area and the hazard warning lights and chime starts, move away from the vehicle with the Smart key. The trunk remains closed.

3. Automatic opening

After the hazard warning lights blink and the chime sounds 6 times, the smart trunk opens.

Deactivating smart trunk

If you press any button on the Smart key during the Detect and Alert stage, the smart trunk is deactivated.

Using the Smart key:

- If you press the door unlock button, the smart trunk is deactivated temporarily. If you do not open any door for 30 seconds, the smart trunk is activated again.
- If you press the trunk open button for more than 1 second, the trunk opens.
- The smart trunk is still activated if you press the door lock button or trunk open/close button as long as the smart trunk is not in the Detect and Alert stage.

Detecting area

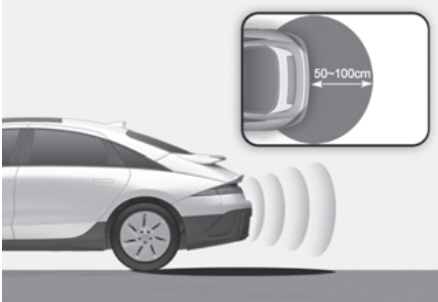

- The smart trunk detecting area extends about 50-100 cm (20-40 in.) behind the vehicle. If you are positioned in the detecting area and are carrying the Smart key, the hazard warning lights will blink and the chime will sound for about 3 seconds to alert you that the trunk will open.
- The alert stops once the Smart key is moved outside of the detecting area within the 3 second period.

i Information

- Smart trunk may not operate properly if any of the following occur:
 - The Smart key is close to a radio transmitter such as a radio station or an airport which can interfere with normal operation of the transmitter.
 - The Smart key is near a mobile two way radio system or a mobile phone.
 - Another vehicle's Smart key is being operated close to your vehicle.
- The temperature drops below zero degree.
- Smart trunk detecting area may change when:
 - The vehicle is parked on an incline or slope.
 - One side of the vehicle is raised or lowered relative to the opposite side.

Electric charging door



The driver can open and close the charging door with the following methods:

- When the shift gear is in P (Park), push the charging door to open/close
- Push the Close button located inner part of the charging door
- Use the Voice Recognition

NOTICE

- If the charging door does not open because ice has formed around it, tap lightly or push on the door to break the ice and release the door. If necessary, use hand temperature to melt down the ice or move the vehicle to a warm place and allow the ice to melt. Do not pry on the charging door or use unauthorized tools to open the charging door.
- After closing the charging door, push the door again to ensure that the charging door is completely closed.

- Make sure that the charging door is closed before driving the vehicle. If the charging door is opened, mechanical parts of the charging door can be damaged.
- After closed the charging door, be sure to check the warning light is off.
- After charging the vehicle, close the charging inlet by the charging inlet cover properly. If the charging inlet cover is closed improperly, the charging inlet and the charging door can be damaged.
- Do not pry on the charging door while the charging door is opening. The charging door may stop moving. Also, the electrical mechanism of the charging door and its related parts can be severely damaged.
- While washing the vehicle, do not spray a high pressure water to the charging door directly. The high pressure can damage the charging door.

⚠ CAUTION

- The charging door opens sideways. Check the surrounding while the charging door is open or close. Be aware of your head or limbs from being hit or stuck to the charging door.
- Do not hold the hinge to prevent damaging the charging door and causing other accidents.

i Information

- The charging door automatically closes when:
 - The charging connector is disconnected
 - The door is opened and the charging connector is not connected for a certain period of time
 - The gear is not in P (Park)
- After replacing battery (12 V), open and close the charging door once to check that the charging door automatic opening mechanism is functioning properly.

For more information, refer to the "Charging your electric vehicle" section in chapter 1.

Head-up display

+ if equipped

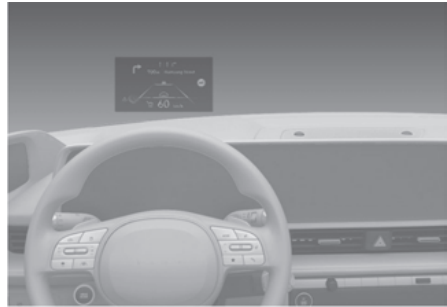

The Head-Up Display is an optional feature that allows the driver to view information projected onto a transparent screen while still keeping your eyes safely on the road ahead while driving.

Head-up display settings

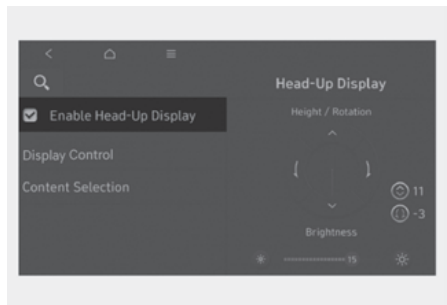

- Head-up display can be enabled from the Settings menu in the infotainment system.

Select **Setup > Vehicle Settings > Head-Up Display > Enable Head-Up Display**

- After turning on the head-up display, you can change the settings of **'Display Control'** and **'Content Selection'** of the Head-Up Display.

i Information

The infotainment system may change after software updates. For more information, refer to the manual provided in the infotainment system and the quick reference guide.

Head-up display information



- (1) Turn by Turn (TBT) navigation
- (2) Traffic signs or speed limit
- (3) Speedometer
- (4) SCC set speed
- (5) SCC vehicle distance
- (6) Lane Following Assist
- (7) Lane Safety
- (8) Blind-Spot Safety

Precautions while using the Head-up display

- It may sometimes be difficult to read information on the Head-Up Display in the following situations.
 - The driver is improperly positioned in the driver's seat
 - The driver wears polarizing-filter sunglasses
 - An object is located above the head-up display cover
 - The vehicle is driven on a wet road
 - Any improper lighting accessory is installed inside the vehicle, or there is incoming light from outside of the vehicle
 - The driver wears glasses
 - The driver wears contact lenses

When it is difficult to read the head-up display information, adjust the image position or brightness level from the Settings menu in the infotainment system.

- Since the information displayed on the head-up display partially overlaps with the road ahead, you may feel fatigue and discomfort while driving. If you feel tired or uncomfortable, adjust the image, and if the symptoms persist, turn off the head-up display before driving.
- For your safety, make sure to stop the vehicle before adjusting the settings.

- Do not tint the front windshield glass or add other types of metallic coating. Otherwise, the head-up display image may be invisible.
- Do not place any accessories on the dashboard or attach any objects on the windshield glass.
- When replacing the front windshield glass, replace it with a windshield glass designed for head-up display operation. Otherwise, duplicated images may be displayed on the windshield glass.

WARNING

- The warning information of Blind-Spot Safety on the Head-Up Display are supplemental. Do not solely depend on function to change lanes. Always take a look around before changing lanes.
The driving route guidance display in the augmented reality mode is an auxiliary function. Be sure to check the navigation screen together.
- ALWAYS pay attention on the road while driving when the Head-Up Display is on.

Information

Head-Up Display includes GPL, LGPL, MPL and other open source license software. All license notices including related source code are provided at <http://www.mobis.co.kr/opensource/list.do>.

If the driver requests on-board software open source code via MOBIS_OSSrequest@mobis.co.kr within 3 years after buying this product, a CD-ROM or other storage device will be sent with the minimum cost covering storage device cost and delivery cost.

Vehicle system OTA update

 If equipped

The OTA (Over-the-Air) software update feature allows you to wirelessly update software to the latest version. Using this feature, you can keep your vehicle system up to date with the latest software.

Downloading software

The latest software can be downloaded automatically while driving. After the latest software has been successfully downloaded, you will receive a notification on your phone or the vehicle screen that the software update is available.

Approving software update

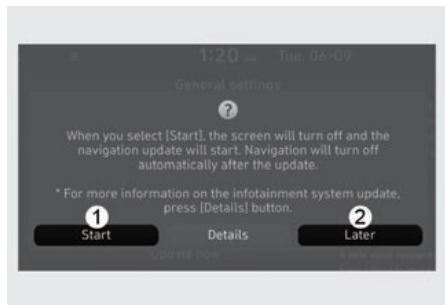

After the vehicle is turned off, the vehicle system will allow you to start the update.

- To start the update, press '**Start**' (1).
- To postpone the update, press '**Later**' (2).

Preparing software update

If you press the **'Start'** button on the screen, the vehicle will begin installing the update automatically. The following conditions must be satisfied:

- The vehicle must be off.
- The gear must be in P (Park).
- The Electronic Parking Brake (EPB) must be applied.
- The exterior lights must be turned off.
- The hood must be closed.
- The battery must be sufficient.
- The systems to be updated must not be running.

i Information

The battery and system status are automatically checked by the vehicle.

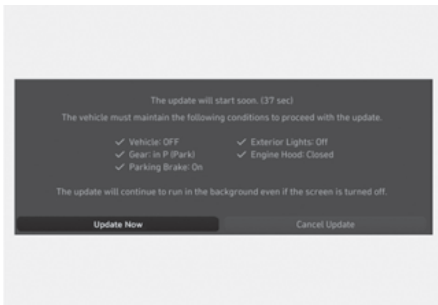

- To update immediately, press **'Update Now'**.
- To cancel the update, press **'Cancel Update'**.

Updating software

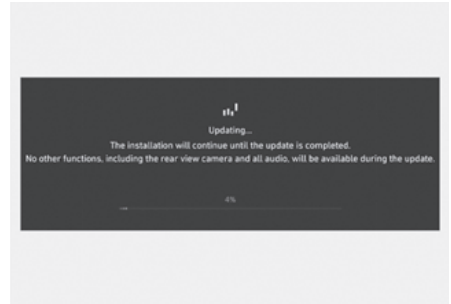

You can see the progress of the update on the screen.

After the update is complete, you will receive a notification on your phone or the vehicle screen that the software update is complete.

i Information

The screen turns off automatically after 3 minutes to save the battery. If the screen turns off automatically, you can check the update progress by pressing the Start/Stop button.

i Information

- After the update starts, you can exit the vehicle.
 - The OTA software update feature is only available for HYUNDAI Connected Services users.
 - The update details may vary depending on the installed software version.
 - Check the notice for the OTA software update on the HYUNDAI brand web.
 - If the update fails, the update recovery will automatically proceed. If you want to retry the software update, even after a successful recovery, we recommend you to contact HYUNDAI.
 - If the update or recovery fails, we recommend you to contact HYUNDAI Call Center.
 - After the update is complete, it may provide new functions or improvements. For more information, see the "OTA Software Update" page on the HYUNDAI brand web or scan the QR code on the screen.
-

NOTICE

- Observe the following restrictions during the update.
 - You cannot use the vehicle during the update. Be sure to have enough time for the update, and safely park the vehicle before starting the update process.
 - You cannot use remote features, including remote start.
 - The Rear Occupant Alert feature may not work. Check if there are any occupant in the rear seat.
 - The update will be automatically canceled if any vehicle conditions required for the update are changed before starting the update.
 - Once the update has started, you cannot cancel the update.
 - You cannot use the OTA software update feature if you modify or replace any vehicle software.
 - Do not open the hood or replace the battery in the vehicle during the update. The update may fail.
 - If a diagnostic tool of any kind is connected to the vehicle OBD (On-board Diagnostic) terminal, the vehicle cannot be updated. The vehicle can be updated by removing the diagnostic tool connected to the OBD terminal and then restarting the vehicle.
 - If the update is not complete successfully, we highly recommend you to contact HYUNDAI.
-

Lighting

Exterior lights

Lighting control

To operate the lights, turn the knob at the end of the control lever to one of the following positions:

Type A

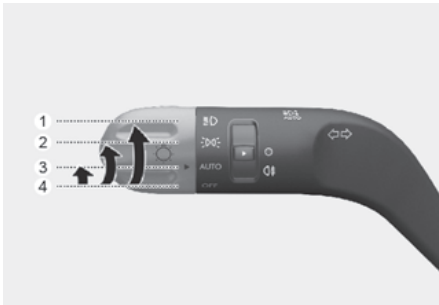

Type B

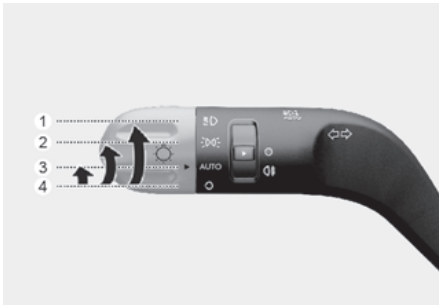

Type C

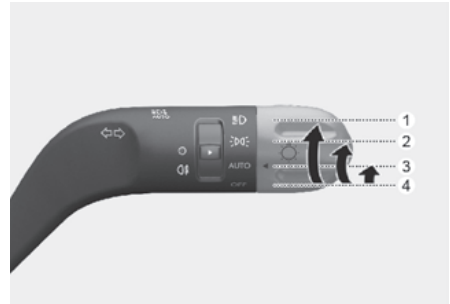

- (1) OFF
- (2) AUTO headlight
- (3) Position light
- (4) Headlight

Daytime Running Light (DRL)

The Daytime Running Lights (DRL) can make it easier for others to see the front of your vehicle during the day, especially after dawn and before sunset.

The DRL system will turn the dedicated light OFF when:

- The headlights are ON.
- The parking brake is applied.
- The vehicle is turned off.

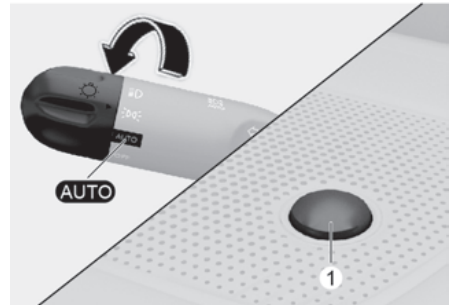

AUTO headlight

The position light and headlight will be turned ON or OFF automatically depending on the amount of daylight as measured by the ambient light sensor (1) at the upper end of the windshield glass.

Even with the AUTO headlight feature in operation, it is recommended to manually turn ON the headlights when driving at night or in a fog, driving in the rain, or when you enter dark areas, such as tunnels and parking facilities.

NOTICE

- Do not cover or spill anything on the sensor (1) located at the upper end of the windshield glass.
 - Do not clean the sensor using a window cleaner, the cleanser may leave a light film which could interfere with sensor operation.
 - If your vehicle has window tint or other types of metallic coating on the front windshield, the AUTO headlight system may not work properly.
-



Position light (☞☞)

The position light, license plate light and instrument panel light are turned ON.



Headlight (☞☞)

The headlight, position light, license plate light and instrument panel light are turned ON.

i Information

The Start/Stop button must be in the ON position to turn on the headlight.

High beam operation

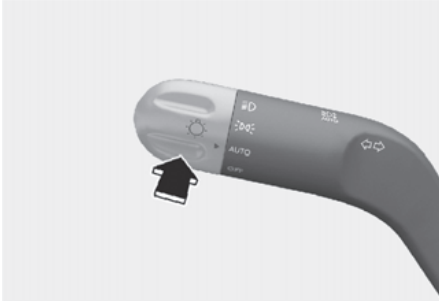

To turn on the high beam headlight, push the lever away from you. The lever will return to its original position.

The high beam indicator will light when the headlight high beams are switched on.

To turn off the high beam headlight, pull the lever towards you. The low beams will turn on.

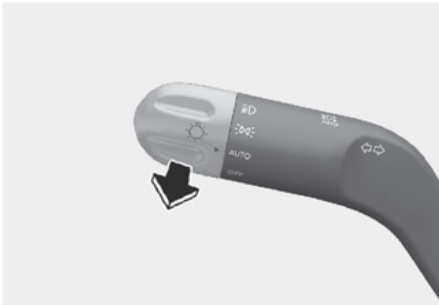

To flash the high beam headlight, pull the lever towards you, then release the lever. The high beams will remain ON as long as you hold the lever towards you.

Turn signals and lane change signals

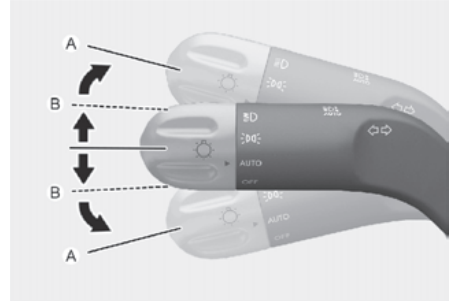

To signal a turn, push down on the lever for a left turn or up for a right turn in position (A).

If an indicator stays on and does not flash or if it flashes abnormally, one of the turn signal bulbs may be burned out and will require replacement.

One touch turn signal

To use One Touch Turn Signal push the turn signal lever up or down to position (B) and then release it.

The lane change signals will blink 3, 5 or 7 times.

You can enable the One Touch Turn Signal function or choose the number of blinking by selecting **Setup > Vehicle Settings > Lights > One Touch Turn Signal** (or **One-touch indicator**) > **3 flashes/5 flashes/7 flashes/Off** in the infotainment system.

i Information

The infotainment system may change after software updates. For more information, refer to the manual provided in the infotainment system and the quick reference guide.

Rear fog light

 if equipped



To turn on the rear fog light:

Position the headlight switch in the headlight position, and then turn the headlight switch (1) to the rear fog light position.

To turn the rear fog lights off, do one of the following:

- Turn off the headlight switch.
- Turn the headlight switch to the rear fog light position again.

Battery saver function

The purpose of this feature is to prevent the battery from being discharged. The system automatically turns off the position light when the driver turns the vehicle off and opens the driver-side door.

With this feature, the position lights will turn off automatically if the driver parks on the side of road at night.

However, the position lights stay ON even when the driver-side door is opened if the light headlight switch is turned to the position light or AUTO (if equipped) position after the vehicle is turned off.

If necessary, to keep the lights on turn the position lights OFF and ON again using the headlight switch on the steering column after the vehicle is turned off.

Headlight delay function

If the Start/Stop button is in the ACC position or the OFF position with the headlights ON, the headlights (and/or position lights) remain on for about 5 minutes. However, if the driver's door is opened and closed, the headlights are turned off after 15 seconds. Also, with the vehicle off if the driver's door is opened and closed, the headlights (and/or position lights) are turned off after 15 seconds.

The headlights (and/or position lights) can be turned off by pressing the lock button on the smart key twice or turning the headlight switch to the OFF or AUTO position.

You can enable the headlight delay function by selecting **Setup > Vehicle Settings > Lights > Headlight Delay** (or **Headlight time-out**) in the infotainment system.

i Information

The infotainment system may change after software updates. For more information, refer to the manual provided in the infotainment system and the quick reference guide.

NOTICE

If the driver exits the vehicle through another door besides the driver door, the battery saver function does not operate and the headlight delay function does not turn OFF automatically.

This may cause the battery to discharge. To avoid battery discharge, turn OFF the headlights manually from the headlight switch before exiting the vehicle.

Headlight leveling device



Manual type

if equipped

To adjust the headlight beam level according to the number of the passengers and loading weight in the luggage area, turn the beam leveling switch.

The higher the number on the switch position, the lower the headlight beam level. Always keep the headlight beam at the proper leveling position, or headlights may dazzle other road users.

Listed below are examples of appropriate switch settings for varying loads. For loading conditions other than those listed, adjust the switch position to the most similar situation.

Loading condition	Switch position
Driver only	0
Driver + Front passenger	0
Full passengers (including driver)	1
Full passengers (including driver) + Maximum permissible loading	2
Driver + Maximum permissible loading	3

! WARNING

If the function does not work properly, we recommend that the system be inspected by an authorized HYUNDAI dealer. Do not attempt to inspect or replace the wiring yourself.

Automatic type

+ If equipped

This is a device that automatically adjusts the angle of the headlights when the inclination of the vehicle changes according to the change in vehicle weight (occupants and cargo loading) to secure the driver's visibility at night and reduce the fatigue of the occupants. It can also provide constant angle lighting under different conditions.

! CAUTION

If the automatic headlight angle adjustment device does not work even when the vehicle is tilted backwards due to changes in the occupants or vehicle load, or if the headlight angle does not work at a certain angle due to the top or bottom tilt, we recommend that the system be inspected by an authorized HYUNDAI dealer. Do not attempt to inspect or replace the wiring yourself.

Welcome system

+ If equipped

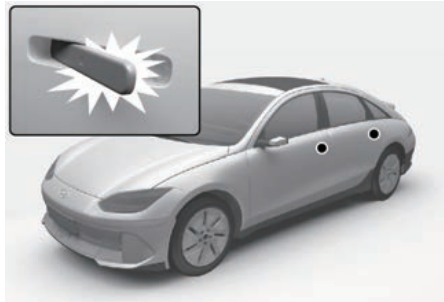

Welcome system helps keep the driver visible by turning on vehicle lights when the driver approaches the vehicle.

Door handle light

When all the doors (and trunk) are closed and locked, the door handle light will turn on for about 15 seconds if any of the below is performed.

When the door unlock button is pressed on the smart key.

When you put your hand in the outside door handle with the Smart key in possession. If **Setup > Vehicle Settings > Lights > Welcome Mirror/ Light > Enable on Driver Approach** is selected from the Settings menu in the infotainment system, the lights will turn on when the vehicle is approached with the smart key in possession.

i Information

The infotainment system may change after software updates. For more information, refer to the manual provided in the infotainment system and the quick reference guide.

Headlight and position light

When the light switch is ON, and all the doors (and trunk) are closed and locked, the headlight and position light will turn on for about 15 seconds if the door unlock button is pressed on the smart key. Note that if the light switch is in the AUTO position, the headlight and position light will turn on only when it is dark outside.

Select **Setup > Vehicle Settings > Lights > Headlight Delay(or Headlight time-out)** from the Settings menu to turn on this function.

Interior lamp

When the interior lamp switch is in the  position and all doors (and trunk) are closed and locked, the room lamp will come on for 30 seconds if any of the below is performed.

- When the door unlock button is pressed on the smart key.
- When you put your hand in the outside door handle while carrying the Smart key.

At this time, if you press the door lock button on the Smart key the lamps will turn off immediately.

Interior lights

WARNING

Do not use the interior lights when driving in the dark. The interior lights may obscure your view and cause an accident.

NOTICE

Do not use the interior lights for extended periods when the vehicle is turned off or the battery will discharge.

Interior lamp AUTO cut

The interior lamps will automatically go off about 20 minutes after the vehicle is turned off and the doors are closed. If a door is opened, the lamp will go off 25 minutes after the vehicle is turned off. If the doors are locked by the smart key and the vehicle enters the armed stage of the theft alarm system, the lamps will go off five seconds later.

Front lamps



Front map lamp (☞☞):

Touch either icons to turn the map lamp on or off. This light produces a spot beam for convenient use as a map lamp at night or as a personal lamp for the driver and the front passenger.

Door lamp (☞☞):

The front or rear room lamps come on when the front or rear doors are opened. When doors are unlocked by the smart key, the front and rear lamps come on for about 30 seconds as long as any door is not opened. The front and rear room lamps go out gradually after about 30 seconds when the door is closed. However, if the Start/Stop button is in the ON position or all doors are locked, the front and rear lamps will turn off. If a door is opened with the Start/Stop button in the ACC position or the OFF position, the front and rear lamps will stay on for about 10 minutes.

Room lamp (☞☞):

Press the button to turn ON the room lamp for the front/rear seats.

Mood lamp (☞☞):

+ if equipped

Press the button to turn On the mood lamp. Press again to turn the lamp off.

Rear lamp

Room lamp

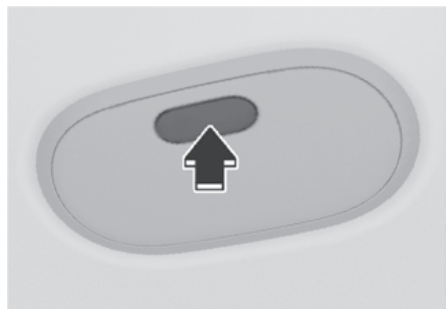



Push the button to turn the light on or off.

Vanity mirror lamp

 if equipped



Push the switch to turn the light on or off.

- :
The lamp will turn on if this button is pressed.
- :
The lamp will turn off if this button is pressed.

NOTICE

Always have the switch in the off position when the vanity mirror lamp is not in use. If the sunvisor is closed without the lamp off, it may discharge the battery or damage the sunvisor.

Glove box lamp



Opening the glove box comes on the lamp. When the glove box is not closed completely, the lamp may keep coming on.

Mood lamp

Dashboard mood lamp



Door mood lamp



- To set the brightness and color of the mood lamp, select **Setup > Vehicle Settings > Lights > Ambient Light** in the infotainment system.
- When driving at night or under low light driving conditions, the sensors detect the light level around the vehicle and automatically adjust the brightness of the mood lamp. To set the automatic brightness adjustment turn On/Off, select **Setup > Vehicle Settings > Lights > Ambient Light > Dimmed in Dark**.
- When you select **Setup > Vehicle Settings > Lights > Ambient Light > Link to Drive Mode** in the infotainment system, the driver's and front passenger's mood lamps are set in color in conjunction with the drive mode. In the case of the rear seat, if the '**Link to Drive Mode**' function is selected while the speed-linked interior lighting is not selected, the rear seat mood lamp changes color in conjunction with the drive mode.
- When you select **Setup > Vehicle Settings > Lights > Ambient Light > Link to Speed Alert** in the infotainment system, the driver's and front passenger's mood lamps change to red and blink when the vehicle speed exceeds the speed limit. In the case of the rear seat, when the '**Sync Lighting with Speed**' function is set, the mood lamp does not turn on even if the '**Link to Speed Alert**' function is set, but the mood lamp changes to red and blink when the vehicle speed exceeds the speed limit.
- When you select **Setup > Vehicle Settings > Lights > Ambient Light > Sync Lighting with Speed** in the infotainment system, the brightness of the driver's and front passenger's mood lamps changes according to the speed. In the case of the rear seat, when the '**Sync Lighting with Speed**' function is selected, the mood lamp is turned on only in the P (park). However, if the '**Link to Speed Alert**' function is selected, the rear seat mood lamp will also blink in red when the vehicle speed exceeds the speed limit.
- After selecting **Setup > Vehicle Settings > Lights > Ambient Light > Link to Voice Recognition** in the infotainment system, when the voice recognition button on the steering wheel is pressed, the length of the dashboard's mood lamp lighting changes according to the volume of the user's voice and the pitch of the vehicle guidance voice.

- When the driver gets into the vehicle, the mood lamp on the dashboard turns on in sequence in conjunction with the welcome animation on the instrument panel. When getting off, the mood lamp on the dashboard turns off one after another in conjunction with the good-bye animation on the instrument panel.
- When the vehicle is drivable (the instrument panel **READY** indicator is on), the dashboard mood lamp turns on. However, the mood lamp does not turn on when using the utility mode.

i Information

- The infotainment system may change after software updates. For more information, refer to the manual provided in the infotainment system and the quick reference guide.
- The color of the mood lamp may seem different under some conditions depending on the color of the interior and the set mood color.

Front trunk lamp

The lamp illuminates when the hood opens.

The lamp keeps coming on when the hood is not completely closed.



NOTICE

Make sure it is fully closed after closing the hood. If it is left open without starting vehicle, the lamp comes on and the battery may be discharged.

Luggage compartment lamp

The lamp turns on when the trunk is open.

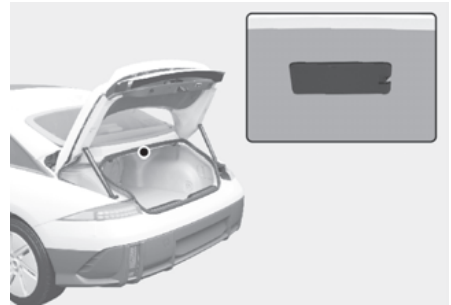

NOTICE

Make sure it is fully closed after closing the trunk. If it is left open without starting vehicle, the lamp comes on and the battery may be discharged.

High Beam Assist (HBA)

 If equipped

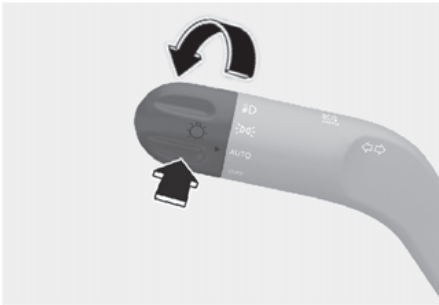

High Beam Assist will automatically adjust the headlight range (switches between high beam and low beam) depending on the brightness of detected vehicles and certain road conditions.

Detecting sensor



(1) front view camera

The front view camera is used as a detecting sensor to detect ambient light and brightness while driving.

Refer to the picture above for the detailed location of the detecting sensor.

NOTICE

- Always keep the front view camera in good condition to maintain optimal performance of High Beam Assist.
- For more information on the precautions of the front view camera, refer to the "Forward Collision Avoidance Assist (FCA)" section in chapter 7.

High Beam Assist settings

Setting features

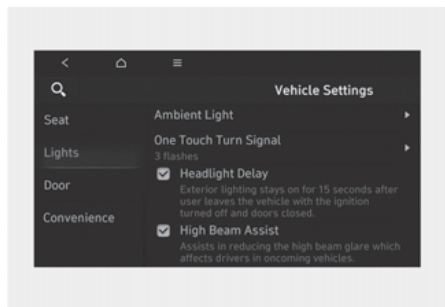



With the Start/Stop button in the ON position, select **Lights > High Beam Assist** or **Travel Mode** from the Vehicle Settings menu to turn on High Beam Assist and deselect to turn off the function.

WARNING

For your safety, change the Settings after parking the vehicle at a safe location.

High Beam Assist operation

Display and control

- After selecting 'High Beam Assist' in the Settings menu, High Beam Assist will operate by following the procedure below.
 - Place the headlight switch in the AUTO position and push the headlight lever towards the instrument cluster. The High Beam Assist  indicator light illuminates on the instrument cluster and High Beam Assist will be enabled.
 - When High Beam Assist is enabled, high beam will turn on when vehicle speed is above 40 km/h (25 mph). When vehicle speed is below 25 km/h (15 mph), high beam will not turn on and the High Beam Assist  indicator will be displayed in white on the instrument cluster.
 - The High Beam  indicator light will illuminate on the instrument cluster when high beam is on.
- When High Beam Assist is operating, if the headlight lever or switch is used, High Beam Assist operates as follow:
 - If the headlight lever is pulled towards you when the high beam is off, the high beam will turn on without High Beam Assist canceled. When you let go of the headlight lever, the lever will move to the middle and the high beam will turn off.
 - If the headlight lever is pulled towards you when the high beam is on by High Beam Assist, low beam will be on and the function will turn off.
 - If the headlight switch is placed from AUTO to another position (headlight/position/off), High Beam Assist will turn off and the corresponding light will turn on.
- When High Beam Assist is operating, high beam switches to low beam if any of the following conditions occur:
 - When the headlight of an oncoming vehicle is detected.
 - When the tail light of a vehicle in front is detected.
 - When the headlight or tail light of a motorcycle or a bicycle is detected.
 - When the surrounding ambient light is bright enough that high beams are not required.
 - When streetlights or other lights are detected.

i Information

The images or colors may be displayed differently depending on the specifications of the instrument panel or theme.

High Beam Assist malfunction and limitations

High Beam Assist malfunction

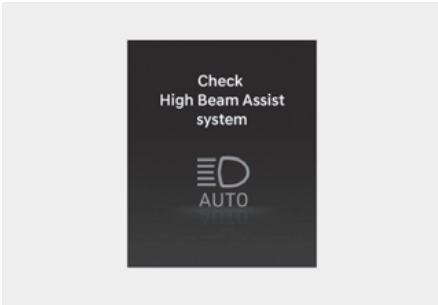

When High Beam Assist is not working properly, the '**Check High Beam Assist system**' warning message will appear and  warning light will illuminate on the instrument cluster. We recommend that the function be inspected by an authorized HYUNDAI dealer.

Limitations of High Beam Assist

High Beam Assist may not work properly in the following situations:

- Light from an oncoming or front vehicle is not detected because of lamp damage, or because it is hidden from sight, etc.
- Headlight of an oncoming or front vehicle is covered with dust, snow or water.
- A front vehicle's headlights are off but the fog lights are on and etc.
- There is a light that has a similar shape as a vehicle's light.
- Headlights have been damaged or not repaired properly.
- Headlights are not aimed properly.

- Driving on a narrow curved road, rough road, uphill or downhill.
- Vehicle in front is partially visible on a crossroad or curved road.
- There is a traffic light, reflecting sign, flashing sign or mirror ahead.
- There is a temporary reflector or flash ahead (construction area).
- The road conditions are bad such as being wet, iced or covered with snow.
- A vehicle suddenly appears from a curve.
- The vehicle is tilted from a flat tire or is being towed.
- Light from an oncoming or front vehicle is not detected due to obstacles in the air such as exhaust fume, smoke, fog, snow, or water spray or blizzard on the road, or fogging in the light, etc.

Information

For more information on the limitations of the Front View Camera, refer to the "Forward Collision Avoidance Assist (FCA)" section in chapter 7.

WARNING

- At times, High Beam Assist may not work properly. High Beam Assist is for your convenience only. It is the responsibility of the driver for safe driving practices and always check the road conditions for your safety.
- When High Beam Assist does not operate normally, change the headlight position manually between high beam and low beam.
- When starting up or initializing the front camera (rebooting, etc.), the High Beam Assist function may not work for about 15 seconds.

Intelligent Front-Lighting System (IFS)

+ if equipped

Intelligent Front-Lighting System secures a clear view for the driver with the high beam on while driving at night.

System setting

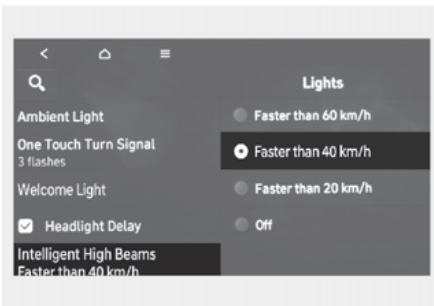

With the Start/Stop button in the ON position, select **Setup > Vehicle Settings > Lights > Intelligent or Smart High Beams** from the Settings menu to turn on Intelligent Front-Lighting System and deselect to turn off the system.

! WARNING

For your safety, change the Settings after parking the vehicle at a safe location.

i Information

Travel Mode must be turned on for the headlight on the driver's side to turn off when driving from a left-hand drive country to a right-hand drive country and vice versa.

To turn on the Travel mode, select **Setup > Vehicle > Light > Travel Mode** from the infotainment system.

System operation



After selecting '**Intelligent High Beams**' in the Settings menu, Intelligent Front-Lighting System will operate by following the procedure below.

- Place the headlight switch in the AUTO position and push the head light lever toward the instrument cluster. The Intelligent Front-Lighting System (IFS) indicator light will illuminate on the instrument cluster and the system will be enabled.
- When the system is enabled, the Intelligent Front-Lighting System will operate according to the set speed in the infotainment system. The initial system is set to work when vehicle speed is above 40 km/h (25 mph).
- The high beam LED partially turns off if an oncoming vehicle or a vehicle ahead is detected by the front view camera.
- If Intelligent Front-Lighting System detects an oncoming vehicle or a vehicle ahead while driving at high speed (about above 100 km/h (60 mph), the driver's side headlight will turn off and only the passenger's side headlight will be controlled by the system.

System malfunction and limitations

System malfunction

Type A

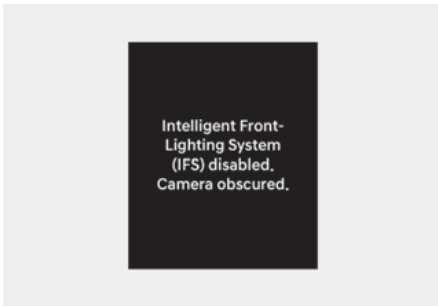

Type B

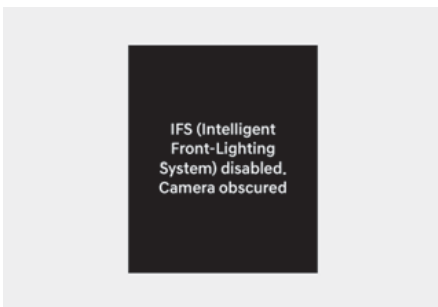

When Intelligent Front-Lighting System is not working properly, the '**Check Intelligent Front-Lighting System (IFS)**' warning message will come on for a few second on the instrument cluster. After the message disappears, the AFS and  will illuminate on the instrument cluster. We recommend that the system be inspected by an authorized HYUNDAI dealer.

Type A

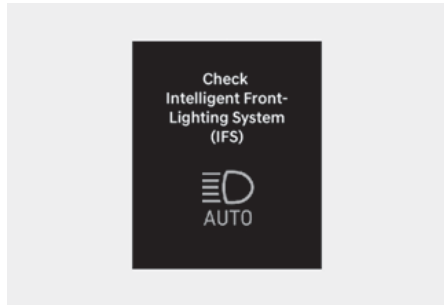

Type B

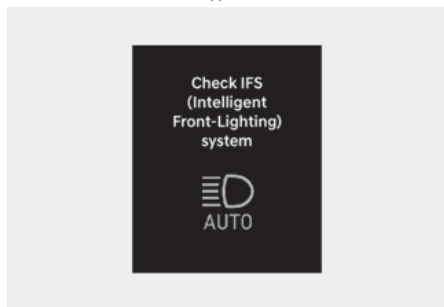

When the front view camera is covered with dirt, snow, or debris, Intelligent Front-Lighting System may temporarily not work properly. If this occurs, a warning message will appear on the instrument cluster.

The system will operate normally when such dirt, snow or debris is removed.

Intelligent Front-Lighting System may not properly operate in an area (for example, open terrain) where any objects or vehicles are not detected after turning on the vehicle.

Also, even though a warning message does not appear on the instrument cluster, the system may not properly operate.

Limitations of the system

Intelligent Front-Lighting System may not work properly in the following situations:

- Light from a vehicle is not detected because of lamp damage, or because it is hidden from sight, etc.
- Headlight of a vehicle is covered with dust, snow or water.
- A vehicle's headlights are off but the fog lights are on and etc.
- There is a light that has a similar shape as a vehicle's light.
- Headlights have been damaged or not repaired properly.
- Headlights are not aimed properly.
- Driving on a narrow curved road, rough road, uphill or downhill.
- Vehicle in front is partially visible on a crossroad or curved road.
- There is a traffic light, reflecting sign, flashing sign or mirror ahead.
- There is a temporary reflector or flash ahead (construction area).
- The road conditions are bad such as being wet, iced or covered with snow.
- A vehicle suddenly appears from a curve.
- The vehicle is tilted from a flat tire or is being towed.
- There are many street lights or the ambient light is bright.
- Light from a vehicle is not detected because of exhaust fume, smoke, fog, snow, etc.
- The front windshield is covered with foreign substance.

NOTICE

For more information on the limitations of the front view camera, refer to the "Forward Collision Avoidance Assist (FCA)" section in chapter 7.

⚠ WARNING

- At times, Intelligent Front-Lighting System may not work properly. The system is for your convenience only. It is the responsibility of the driver for safe driving practices and always check the road conditions for your safety.
- When the system does not operate normally, switch the headlight position manually between high beam and low beam.

Wipers and washers

Type A

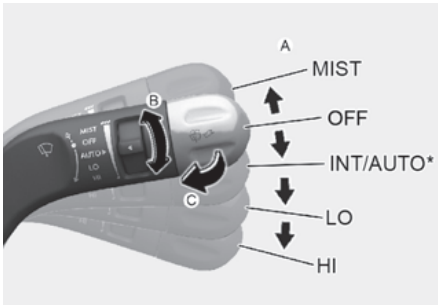

Type B

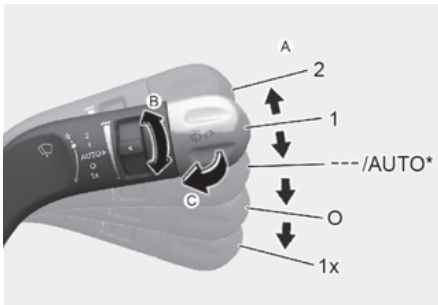

Type C

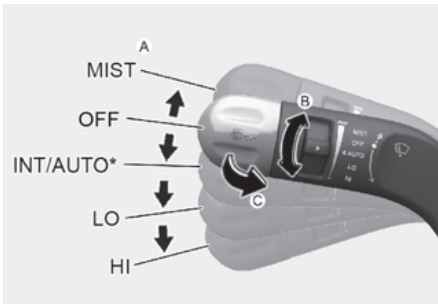

A. Wiper speed control

- MIST / 1x - Single wipe
- OFF / O - Off
- INT / --- - Intermittent wipe
- AUTO* - Auto control wipe
- LO / 1 - Low wiper speed
- HI / 2 - High wiper speed

*: if equipped

B. Intermittent wipe time adjustment/Auto control wipe time adjustment*

C. Wash with brief wipes

Front windshield wipers

Operates as follows when the Start/Stop button is in the ON position.

MIST (1x):

For a single wiping cycle, push the lever upward (or downward) and release. The wipers will operate continuously if the lever is held in this position.

OFF (O):

Wiper is not in operation.

INT (---):

Wiper operates intermittently at the same wiping intervals. To vary the speed setting, turn the speed control knob (B).

AUTO:

The rain sensor located on the upper end of the windshield glass senses the amount of rainfall and controls the wiping cycle for the proper interval. The more it rains, the faster the wiper operates. When the rain stops, the wiper stops. To vary the speed setting, turn the speed control knob.

LO (1):

The wiper runs at a lower speed.

HI (2):

The wiper runs at a higher speed.

i Information

If there is heavy accumulation of snow or ice on the windshield, defrost the windshield for about 10 minutes, or until the snow and/or ice is removed before using the windshield wipers to ensure proper operation.

If you do not remove the snow and/or ice before using the wiper and washer, it may damage the wiper and washer system.

AUTO (Automatic) control

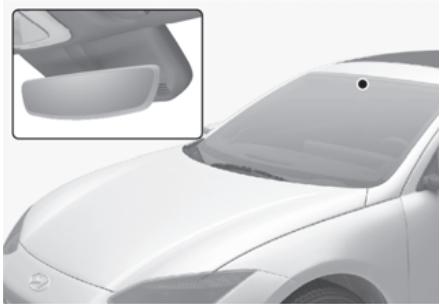

The rain sensor located on the upper end of the windshield glass senses the amount of rainfall and controls the wiping cycle for the proper interval.

The wiper operation time will be automatically controlled depends on rainfall.

When the rain stops, the wiper stops.

To vary the sensitivity setting, turn the sensitivity control knob.

If the wiper switch is set in AUTO mode when the Start/Stop button is in the ON position, the wiper will operate once to perform a self-check of the system. Set the wiper to the OFF (O) position when the wiper is not in use.

⚠ WARNING

To avoid personal injury from the windshield wipers, when the vehicle is running and the windshield wiper switch is placed in the AUTO mode:

- Do not touch the upper end of the windshield glass facing the rain sensor.
- Do not wipe the upper end of the windshield glass with a damp or wet cloth.
- Do not put pressure on the windshield glass.

NOTICE

- When washing the vehicle, set the wiper switch in the OFF (O) position to stop the auto wiper operation. The wiper may operate and be damaged if the switch is set in the AUTO mode while washing the vehicle.
- Do not remove the sensor cover located on the upper end of the passenger side windshield glass. Damage to system components could occur and may not be covered by your vehicle warranty.
- Because of using a photo sensor, temporary malfunction could occur according to sudden ambient light change made by stone and dust while driving.

Front windshield washers



In the OFF (O) position, pull the lever gently toward you to spray washer fluid on the windshield and to run the wipers 1-3 cycles. The spray and wiper operation will continue until you release the lever. If the washer does not work, you may need to add washer fluid to the washer fluid reservoir.

Recirculating air when washer fluid is used

When washer fluid is used, in order to reduce any objectionable scent of the washer fluid from entering the cabin, recirculation mode and air conditioning are automatically activated depending on the outside temperature. If you select fresh mode while the function is operating, the function will resume after a certain amount of time. It may not work in some conditions such as cold weather or vehicle off.

For more information, refer to the "Climate control additional features" section in this chapter.

! WARNING

When the outside temperature is below freezing, ALWAYS warm the windshield using the defroster to help prevent the washer fluid from freezing on the windshield and obscuring your vision which could result in an accident and serious injury or death.

NOTICE

- To prevent possible damage to the washer pump, do not operate the washer when the fluid reservoir is empty.
- To prevent possible damage to the wipers or windshield, do not operate the wipers when the windshield is dry.
- To prevent damage to the wiper arms and other components, do not attempt to move the wipers manually.
- To prevent possible damage to the wipers and washer system, use anti-freezing washer fluids in the winter season or cold weather.

Automatic climate control system

Climate control panel

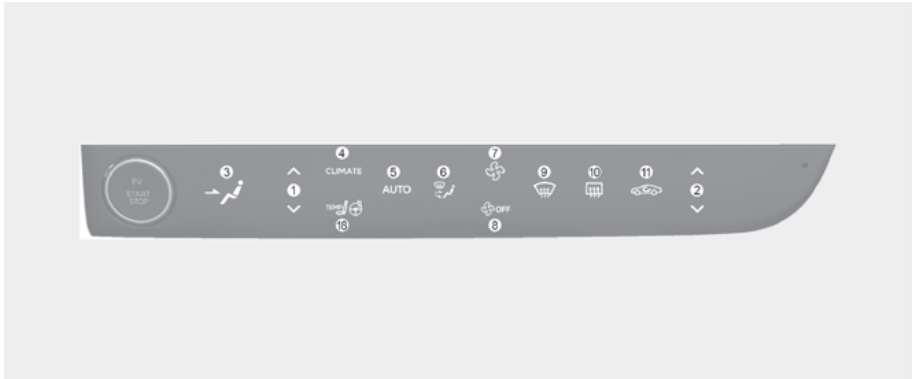

Infotainment System (Climate)



The actual shape for the climate control panel and infotainment system may differ from the illustration.

- (1) Driver's temperature control
- (2) Passenger's temperature control
- (3) Display the air flow direction
- (4) View climate infotainment screen
- (5) AUTO (automatic control)
- (6) Mode selection button
- (7) Fan speed up
- (8) Fan speed down/OFF

Convenience features

- (9) Front windshield defroster
- (10) Rear windshield defroster
- (11) Air intake control
- (12) Driver only mode
- (13) A/C (air conditioning) ON/OFF
- (14) Heating ON/OFF
- (15) SYNC
- (16) Ambient temperature display
- (17) System OFF
- (18) Seat warmer/air ventilation infotainment screen

i Information

Use a clean soft microfiber cloth to gently wipe any finger prints off the touch screen.

Climate

Climate control panel



Touch '**CLIMATE**' icon to view the climate information in the infotainment screen.

Infotainment System

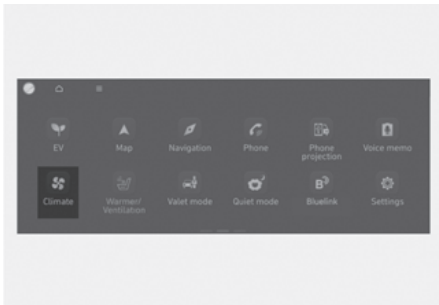

To view the climate information screen, select '**Climate**' in the main infotainment screen when the vehicle is ON.

Automatic temperature control mode

1. Press '**AUTO**' icon or touch the '**AUTO**' icon in the infotainment screen to select the fan speed (level 1-3).

Climate control panel



2. Adjust the temperature with the temperature control icon.

Infotainment system



Level	AUTO Indicator	Climate Information	Fan Speed level
3		HIGH	1-8
2		MEDIUM	1-6
1		LOW	1-4

The fan speed level only can be changed manually.

The following systems can be respectively adjusted while the AUTO climate control is on. When those systems are adjusted, AUTO indicator lights will turn off.

- Fan speed level
- A/C (Air condition)
- Mode selection
- Front windshield defroster (When defroster is turned off, AUTO indicator light will illuminate)

For your convenience and to improve the efficiency of the climate control, use the AUTO button and set the temperature to 22 °C (72 °F).

To change the temperature unit from °C to °F or °F to °C:

Select **Setup > General Settings > Unit > Temperature Unit > °C/°F** from the Settings menu in the infotainment system.

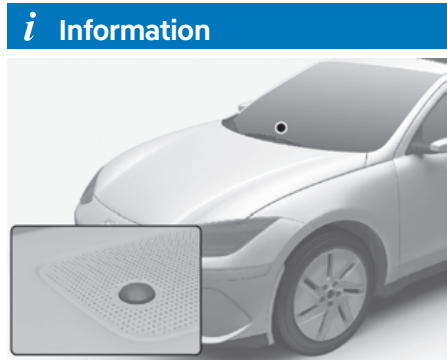

Never place anything near the ambient light/solar sensor to ensure better control of the heating and cooling system.



Manual temperature control mode

The heating and cooling system can be controlled manually by selecting functions other than **'AUTO'**. In this case, the system works sequentially according to the order of the functions selected.

When selecting any other functions except **'AUTO'** while using automatic operation, the functions not selected will be controlled automatically.

1. Start the vehicle.
2. Set the mode to the desired position.

To improve the effectiveness of heating and cooling, select the mode according to the following:

- Heating: 
- Cooling: 

3. Set the temperature control to the desired position.
4. Set the air intake control to Fresh or Recirculation mode.
5. Set the fan speed control to the desired speed.
6. If air conditioning is desired, turn the air conditioning system on.
7. Select **'AUTO'** to revert back to full automatic control of the system.

Mode selection

Climate control panel



Infotainment system



Touch the air flow direction icon in the infotainment screen to select the desired air flow direction. The selected air flow direction will be displayed on the infotainment screen.

Air flow direction

Left-hand drive

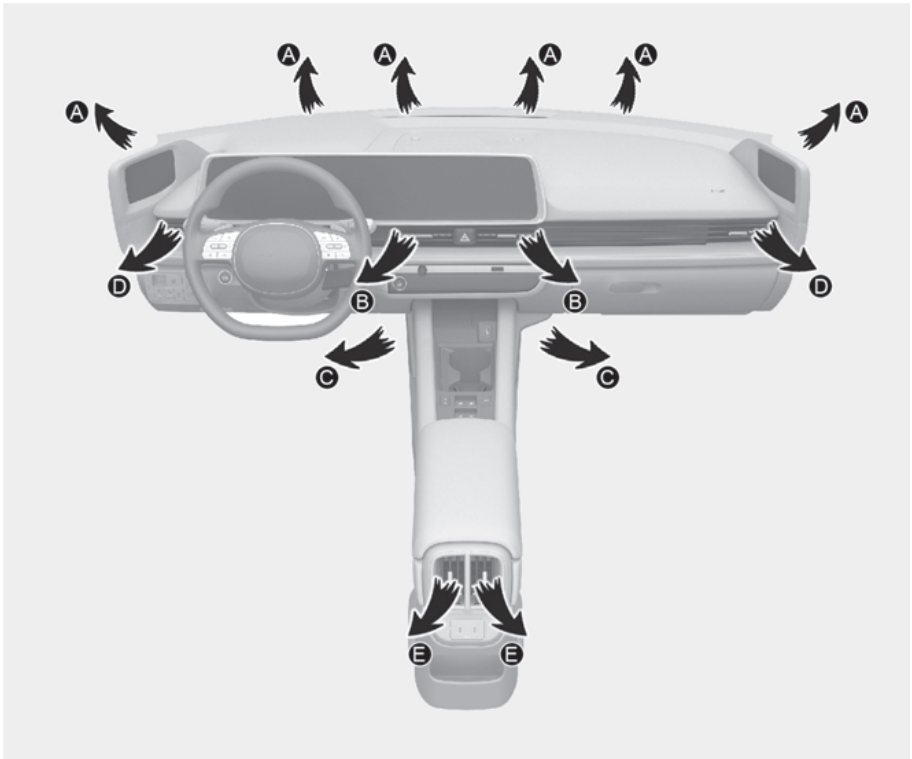

The mode selection icon or button controls the direction of the air flow through the ventilation system.

Air flow direction

Right-hand drive

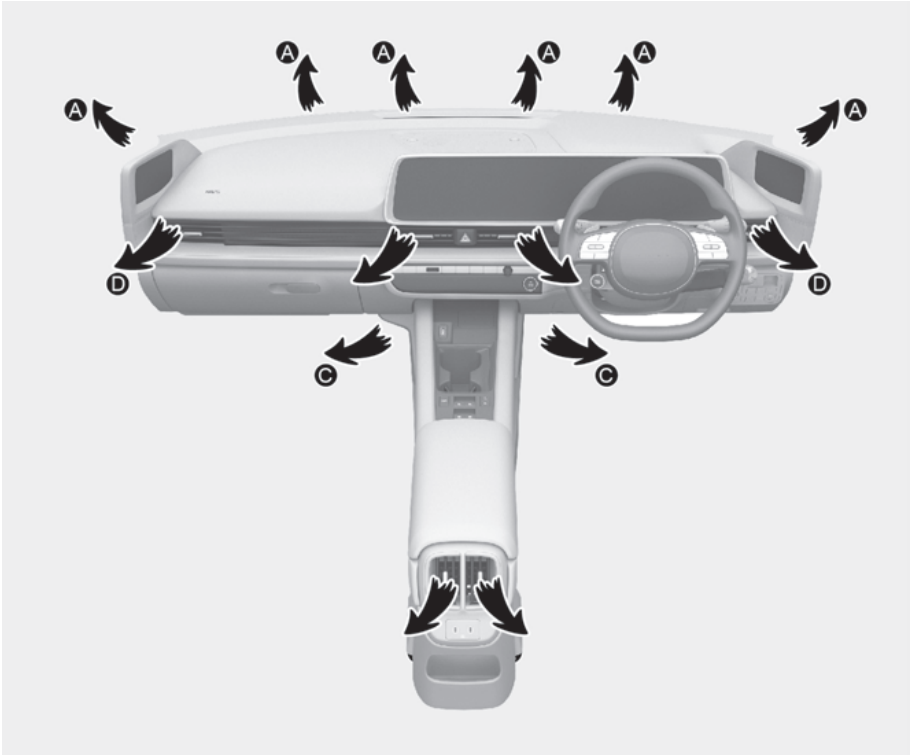

The mode selection Icon or button controls the direction of the air flow through the ventilation system.

Face-Level (B, D)



Air flow is directed toward the upper body and face. Additionally, each outlet can be controlled to direct the air discharged from the outlet.

Bi-Level (B, D, C, E)



Air flow is directed towards the face and the floor.

All Level (A, B, C, D, E, F)



Air flow is directed toward the face, the floor and the windshield.

Floor-Level (A, C, D, E)



Most of the air flow is directed to the floor, with a small amount of the air being directed to the windshield and side window defrosters.

Floor/Defrost-Level (A, C, D, E)



Most of the air flow is directed to the floor and the windshield with a small amount directed to the side window defrosters.

Defroster-Level (A, D)



Most of the air flow is directed to the windshield with a small amount of air directed to the side window defrosters.

Front windshield defroster



Defrost-level (A, D)

Press the icon, and the indicator light will illuminate and the windshield defroster indicator will appear on the climate control panel.

Most of the air flow is directed to the windshield with a small amount of air directed to the side window defrosters.

When Defogging logic is enabled, Fresh mode is selected and air conditioning is selected according to outside temperature.

If the icon is pressed again, the indicator light will turn off and the previous settings will be selected.

Instrument panel vents

Front seat

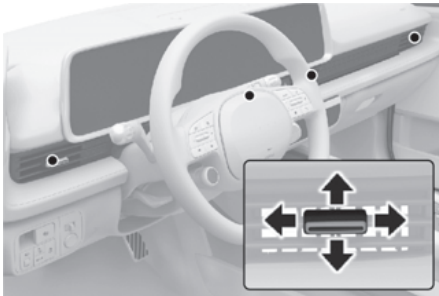

Rear seat

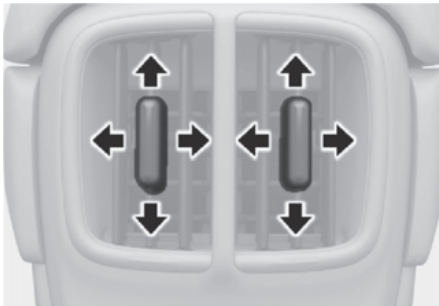

The instrument panel vent air flow can be directed up/down or left/right using the vent adjustment lever.

The air flow can also be closed using the vent adjustment lever.

Front seat

- Move the lever away horizontally from the seat to close until the levers click and lock. Slightly move the lever toward the seating position to unlock and open.

Rear seat

- Move the lever downward to close the air flow. Move the lever upward to open the air flow.

Temperature control

Climate control panel

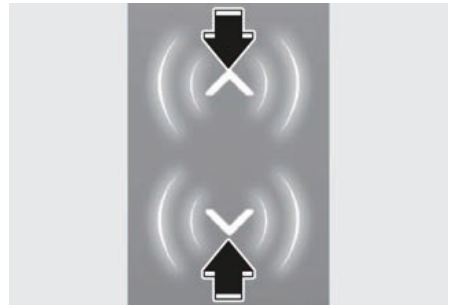

Infotainment system



Touch the \wedge or \vee icon to select the temperature.

The temperature can be increased or decreased by increments of 0.5 °C (1 °F) for each incremental location. When set to the lowest temperature setting, the air conditioning will operate continuously to quickly cool the interior of the vehicle initially. After interior temperature has been cooled down sufficiently, select '**AUTO**' and set the temperature to 22 °C (72 °F).

SYNC



Adjusting the temperature and air flow direction equally

Press '**SYNC**' (indicator light ON), the passenger's temperature and air flow direction will be adjusted same as the driver's control.

Adjusting the temperature and air flow direction individually

Press '**SYNC**' (indicator light OFF), all seats temperature and air flow direction will be adjusted individually.

Air intake control



Air intake control is used to select either Fresh mode (outside air) or Recirculation mode (cabin air).

Recirculation mode



When Recirculation mode is selected, air from the passenger compartment will be recirculated through the system and heated or cooled according to the function selected.

Fresh mode



When Fresh mode is selected, air enters the vehicle from outside and is heated or cooled according to the function selected.

i Information

Operating the system primarily in Fresh mode is recommended. Use Recirculation mode temporarily only when needed. Prolonged operation of the heater in Recirculation mode and without the air conditioning ON can cause fogging of the windshield. In addition, prolonged use of the air conditioning ON in Recirculation mode may result in excessively dry, dehumidified air in the cabin and may promote formation of musty vent odor due to stagnant air.

WARNING

- Continued use of the climate control system operation in Recirculation mode for a prolonged period of time may cause drowsiness to the occupants in the cabin. This may lead to loss of vehicle control which may lead to an accident.
- Continued use of the climate control system operation in Recirculation mode with the air conditioning OFF may allow humidity to increase inside the cabin. This may cause condensation to accumulate on the windshield and obscure visibility.
- Do not sleep in your vehicle or remain parked in your vehicle with the windows up and either the heater or the air conditioning ON for prolonged periods of time. Doing so may increase the levels of carbon dioxide in the cabin which may lead to serious injury or death.

Fan speed control

Climate control panel

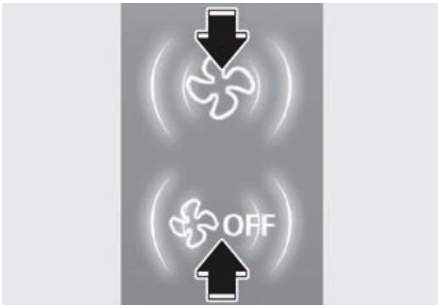

Infotainment system

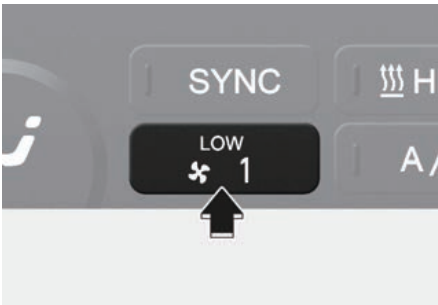

The fan speed can be set to the desired speed by adjusting the  icon in the climate control panel.

More air is delivered with higher fan speeds.

Pressing and holding the  icon turns off the fan.

Information

To help improve microphone voice input sound, fan speed may automatically slow down for a couple of minutes when you activate voice recognition or hands free.

NOTICE

Operating the fan when the Start/Stop button is in the OFF position could cause the battery to discharge. Operate the fan when the vehicle is running.

Driver only



If you touch the '**DRIVER ONLY**' icon  and the indicator light illuminates in the infotainment climate control screen, cold air mostly blows in the driver's seat. However, some of the cold air may come out of other seating position ducts to keep indoor air pleasant. If you use the icon with no passenger in the front passenger seat, energy consumption will be reduced.

'**DRIVER ONLY**' icon will be turned off under the following conditions:

1. Defrost on
2. DRIVER ONLY button re-touch

Air conditioning

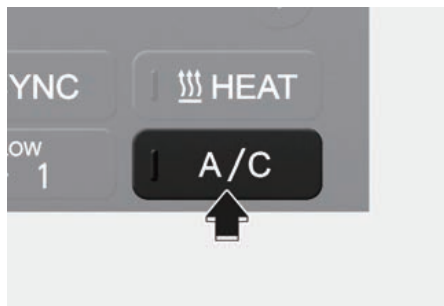

Touch the '**CLIMATE**' icon in the climate control screen. The climate information screen will appear on the infotainment screen. Touch the A/C icon in the infotainment screen to turn the air conditioning on (indicator light ON) and off.

HEAT icon

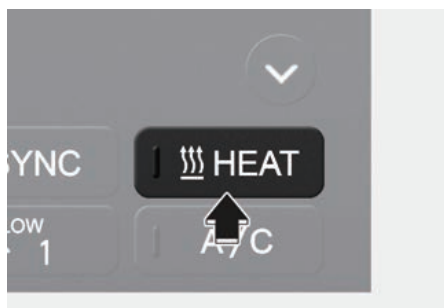

Touch '**CLIMATE**' icon in the climate control screen. The climate information screen will appear on the infotainment screen. Touch the HEAT icon in the infotainment screen to turn the heater on (indicator light will illuminate).

Touch the button again to turn the heater off.

The air conditioner and heater uses energy from the battery. If you use the heater or air conditioner for too long, distance to empty can be reduced due to too much power consumption.

Turn off the heater and air conditioner if you do not need them.

OFF mode



Touch the '**OFF**' icon to turn the climate control system off.

System operation

Cooling/Ventilation

1. Select the Face Level (↶↷) mode in the infotainment screen.
2. Set the air intake control to fresh or recirculation mode.
3. Set the temperature to the desired position.
4. Set the fan speed to the desired speed.

Heating

1. Select the Floor Level (📏) mode in the infotainment screen.
2. Set the air intake control to fresh or recirculation mode.
3. Set the temperature to the desired position.
4. Set the fan speed to the desired speed.
5. If desired, turn the air conditioning ON with the temperature set high in order to dehumidify the air before it enters into the cabin.

If the windshield fogs up, select the Front Defrost (🌬️) mode.

Operation Tips

- To keep dust or unpleasant fumes from entering the vehicle through the ventilation system, temporarily set the air intake control to the recirculation mode. Return the control to the Recirculation mode to the Fresh mode when the unpleasant air outside has diminished. This will help keep the driver alert and comfortable.
- To help prevent the inside of the windshield from fogging, set the air intake control to fresh mode and the fan speed to the desired position, turn on the air conditioning system, and adjust the temperature control to the desired temperature.

Air conditioning

Your HYUNDAI Vehicle air conditioning system is filled with R-134a or R-1234yf refrigerant.

1. Touch the '**CLIMATE**' icon to display climate information the infotainment screen.
2. Select '**A/C**' icon (indicator light ON) in the climate information screen to activate the air-condition.
3. Set the temperature low.
4. Set the direction of air flow by touching the mode selection icon.
5. Touch the '**HEAT**' icon (indicator light OFF) to turn on the air-condition.

When maximum cooling is desired, set the temperature to the lowest position, then set the fan speed control to the highest setting.

Air conditioning system operation tips

- If the vehicle has been parked in direct sunlight during hot weather, open the windows for a short time to let the hot air inside the vehicle escape.
- After sufficient cooling has been achieved, switch back from recirculation mode to fresh mode.
- To help reduce moisture inside of the windows on rainy or humid days, decrease the humidity inside the vehicle by operating the air conditioning system with the windows and vision roof (or solar roof) closed.
- Use the air conditioning system every month only for a few minutes to ensure maximum system performance.

- If you operate air conditioner excessively, the difference between the temperature of the outside air and that of the windshield could cause the outer surface of the windshield to fog up, causing loss of visibility. In this case, set the mode selection to the  position and fan speed control to the lowest speed.

System maintenance

Climate control air filter

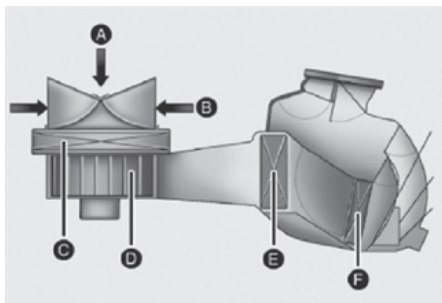

- [A] Outside air
- [B] Recirculated air
- [C] Climate control air filter
- [D] Blower
- [E] Evaporator core
- [F] PTC & Inner condenser

The cabin air filter is installed behind the front trunk. It filters the dust or other pollutants that enter the vehicle through the heating and air conditioning system.

We recommend that the cabin air filter be replaced by an authorized HYUNDAI dealer according to the maintenance schedule. If the vehicle is being driven in severe conditions such as dusty or rough roads, more frequent cabin air filter inspections and changes are required.

If the air flow rate suddenly decreases, we recommend that the system be inspected at an authorized HYUNDAI dealer.

Checking the amount of air conditioner refrigerant and compressor lubricant

When the amount of refrigerant is low, the performance of the air conditioning is reduced. Overfilling also reduces the performance of the air conditioning system.

Therefore, if abnormal operation is found, we recommend that the system be inspected by an authorized HYUNDAI dealer.

NOTICE

It is important that the correct type and amount of oil and refrigerant is used. Otherwise, damage to the compressor and abnormal system operation may occur. To prevent damage, the air conditioning system in your vehicle should only be serviced by trained and certified technicians.

WARNING

Vehicles equipped with R-134a



Since the refrigerant is operated at very high pressure, the air conditioning system should only be serviced by trained and certified technicians.

All refrigerants should be reclaimed with proper equipment.

Venting refrigerants directly to the atmosphere is harmful to individuals and environment. Failure to heed these warnings can lead to serious injuries.

WARNING

Vehicles equipped with R-1234yf



Since the refrigerant is mildly flammable and operated at high pressure, the air conditioning system should only be serviced by trained and certified technicians. It is important that the correct type and amount of oil and refrigerant are used.

All refrigerants should be reclaimed with proper equipment.

Venting refrigerants directly to the atmosphere is harmful to individuals and environment. Failure to heed these warnings can lead to serious injuries.



Air Conditioning refrigerant label

You can find out which air conditioning refrigerant is applied to your vehicle on the label located in the left side of the cowl top cover.

Type A

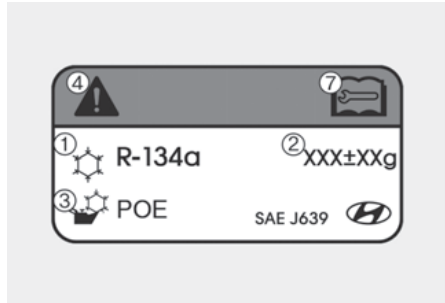

Type B

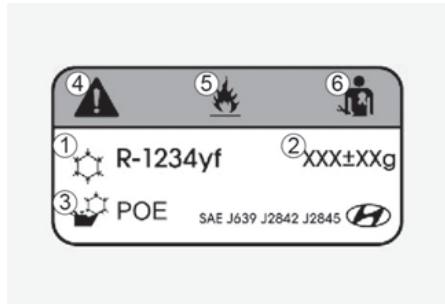



Each symbol and specification on the air conditioning refrigerant label is represented as below:

- (1) Classification of refrigerant
- (2) Amount of refrigerant
- (3) Classification of compressor lubricant
- (4) Caution
- (5) Flammable refrigerant
- (6) To require registered technician to service air conditioning system
- (7) Service manual

Windshield defrosting and defogging

WARNING

Windshield heating

Do not use the  position during cooling operation in extremely humid weather. The difference between the temperature of the outside air and that of the windshield could cause the outer surface of the windshield to fog up, causing loss of visibility could cause an accident resulting in serious injury or death. In this case, set the mode selection to the  position and fan speed control to a lower speed.

- For maximum defrost performance, set the temperature control to the highest temperature setting and the fan speed control to the highest setting.
- If warm air to the floor is desired while defrosting or defogging, set the mode to the floor-defrost position.
- Before driving, clear all snow and ice from the windshield, rear window, outside rearview mirrors, and all side windows.
- Clear all snow and ice from the hood and air inlet in the cowl grill to improve heater and defroster efficiency and to reduce the probability of fogging up the inside of the windshield.

To defog inside windshield

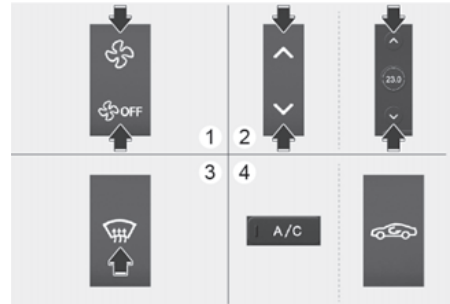

1. Select the desired fan speed.
2. Select the desired temperature.
3. Touch the defroster icon ().
4. When the defogging logic is enabled, Fresh mode is selected and air conditioning is selected according to outside temperature.

Check to make sure the air intake control is in Fresh mode. If the air intake control indicator light is illuminated, touch the icon once to enable Fresh mode (indicator light OFF).

If the  position is selected, the fan speed is automatically increased.

To defrost outside windshield

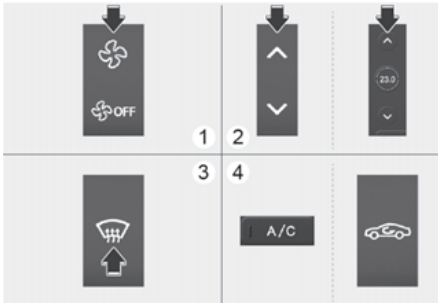

1. Set the fan speed to the highest position.
2. Set the temperature to the extreme hot position.
3. Touch the defroster icon (☀️).
4. When Defogging logic is enabled, Fresh mode is selected and air conditioning is selected according to outside temperature.

Check to make sure the air intake control is in Fresh mode. If the air intake control indicator light is illuminated, touch the icon once to enable Fresh mode (indicator light OFF).

If the ☀️ position is selected, lower fan speed is adjusted to a higher fan speed.

Defogging logic

To reduce the probability of fogging up the inside of the windshield, the air intake or air conditioning are controlled automatically according to certain conditions such as ☀️ positions. To cancel or reset the defogging logic, do the following.

1. Press the Start/Stop button to the ON position.
2. Touch the defroster icon (☀️) or (☀️).
3. While touching the A/C icon, touch the air intake control icon at least 5 times within 3 seconds.

The air intake control indicator will blink 3 times to indicate that the defogging logic has been disabled. Repeat the steps again to re-enable the defogging logic.

The air intake control indicator will blink 6 times to indicate that the defogging logic has been enabled.

If the battery has been discharged or disconnected, it resets to the defog logic status.

Rear window defroster

NOTICE

To prevent damage to the rear window defroster conducting elements bonded to the inside surface of the rear window, never use sharp instruments or window cleaners containing abrasives to clean the window.



The defroster heats the window to remove frost, fog and thin ice from the interior and exterior of the rear window, while the vehicle is running.

- To activate the rear window defroster, touch the rear window icon located in the center control panel. The indicator on the rear window defroster illuminates when the defroster is on.
- To turn off the defroster, touch the rear window defroster button again.

i Information

- If there is heavy accumulation of snow on the rear window, brush it off before operating the rear defroster.
- The rear window defroster automatically turns off after about 20 minutes or when the Start/Stop button is in the OFF position.

Outside rearview mirror defroster

If your vehicle is equipped with the rearview mirror defrosters, they will operate at the same time you turn on the rear window defroster.

Climate control additional features

Auto defogging system

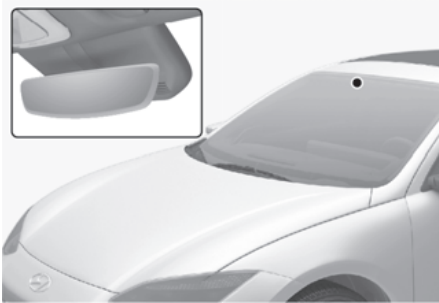

Auto defogging helps reduce the possibility of fogging up the inside of the windshield by automatically sensing the moisture on inside the windshield.

i Information

The auto defogging system may not operate normally, when the outside temperature is below -10°C (14°F).



When the Auto Defogging System operates, the indicator will illuminate.

If a high amount of humidity is detected in the vehicle, the Auto Defogging System will be enabled. The following steps will be performed automatically:

- Except Europe
 - Step 1) Air conditioning will turn ON.
 - Step 2) Air intake control will change to Fresh mode.
 - Step 3) Mode will change to defrost to direct airflow to the windshield.
 - Step 4) Fan speed will be set to MAX.
- For Europe
 - Step 1) Air conditioning will turn ON.
 - Step 2) Air intake control will change to Fresh mode.
 - Step 3) Fan speed will be set to MAX.
 - Step 4) Mode will change to defrost to direct airflow to the windshield

If the air conditioning is off or recirculation mode is manually selected while Auto Defogging System is ON, the Auto Defogging System indicator will blink 3 times to signal that the manual operation has been canceled.

Turning the Auto Defogging System ON or OFF

Climate control system

Touch the front windshield defroster icon for 3 seconds when the Start/Stop button is in the ON position. When the Auto Defogging System is turned off, the ADS OFF symbol will blink 3 times and ADS OFF will be displayed on the climate control information screen.

When the Auto Defogging System is turned on, the ADS OFF symbol will blink 6 times without a signal.

Infotainment system

Auto Defogging System can be turned on and off by selecting **Setup > Vehicle Settings > Climate > Defog/Defrost Options > Auto Defog** from the infotainment system.

i Information

The infotainment system may change after software updates. For more information, refer to the manual provided in the infotainment system and the quick reference guide.

i Information

- When the air conditioning is turned on by Auto Defogging System, if you try to turn off the air conditioning, the indicator will blink 3 times and the air conditioning will not be turned off.
- To maintain the effectiveness and efficiency of the Auto Defogging System, do not select Recirculation mode while the system is operating.
- When Auto Defogging System is operating, fan speed adjustment, temperature adjustment, and air intake control selection are all disabled.

NOTICE

Do not remove the sensor cover located on the upper end of the windshield glass. Damage to system parts could occur and may not be covered by your vehicle warranty.

Auto dehumidify

 if equipped

To increase cabin air quality and reduce windshield misting, recirculation mode switches off automatically after about 5 minutes, depending on the outside temperature, and the air intake will change to fresh mode.

Turning Auto Dehumidify ON or OFF

Climate control system

To turn the Auto Dehumidify feature on or off, select Face level (↔) mode and touch the air intake control icon (🌬️) at least five times within three seconds. When Auto Dehumidify is turned on, the air intake control button indicator will blink 6 times. When turned off, the indicator will blink 3 times.

Infotainment system

Auto Dehumidify can be turned on and off by selecting **Setup > Vehicle Settings > Climate > Automatic Ventilation > Auto Dehumidify** from the infotainment system.

i Information

If the battery (12 V) is discharged or disconnected, Auto dehumidify settings will be reset. Readjust the settings to turning Auto dehumidify option ON or OFF.

NOTICE

The infotainment system may change after software updates. For more information, refer to the manual provided in the infotainment system and the quick reference guide.

Sunroof inside air recirculation

 If equipped

When the sunroof is opened, fresh mode will be automatically selected. At this time, if you press the air intake control button, recirculation mode will be selected but will change back to fresh mode after 3 minutes. When the sunroof is closed, the air intake position will return to the original position that was selected.

Recirculating air when washer fluid is used

Recirculation mode automatically activates to reduce any objectionable scent of the washer fluid from entering the cabin when the windshield washer is used.

Turning Activate upon Washer Fluid Use ON or OFF

Climate control system

Activate upon Washer Fluid Use can be turned on and off by selecting **Setup > Vehicle Settings > Climate > Internal air circulation > Activation on washer fluid use** from the infotainment system.

Information

The infotainment system may change after software updates. For more information, refer to the manual provided in the infotainment system and the quick reference guide.

Recirculating air when entering a tunnel

 If equipped

To prevent the inflow of polluted air into the vehicle when passing through a tunnel, the windows and climate control system are operated using the navigation map information and vehicle speed as follows:

To use this feature, it can be enabled from the infotainment system. Select:

Vehicle > Climate > Internal air circulation

- Tunnel section: The vehicle's windows automatically close, and the climate control system switches to recirculation mode for about 7 seconds before entering a tunnel.

The windows open to the previous position after passing through the tunnel. If the power window switch is operated before the windows open, the windows do not return to the previous position.

Operating conditions

- The climate control system's fresh mode is selected.
- The window(s) are open. The windows close automatically only when your vehicle is applied with the automatic up/down window feature for all seats.

i Information

- The activation time for the feature may differ because of the time gap between the GPS and vehicle speed.
- The feature activates until you have passed through continuous tunnels.
- When entering a tunnel, recirculation mode may cause fogging of the windshield. Use the front windshield defroster button.
- The feature does not operate in short tunnels.
- The feature may not activate if the GPS is not working properly.
- The infotainment system may change after software updates. For more information, refer to the user's manual provided in the infotainment system and the quick reference guide.

WARNING

Be careful not to get any body parts caught when the windows are closing.

Automatic controls linked to climate control settings (for driver's seat)

The temperature of the driver's seat warmer, air ventilated seat and heated steering wheel is automatically controlled depending on the inside and outside temperature of the vehicle when the vehicle is running.

To use these features, it must be enabled from the Settings menu in the infotainment system. Select:

- **Setup > Vehicle Settings > Seats > Warmer/Ventilation Features > Link to Climate Settings for Auto-Adjustment > Driver Seat Warmer/Ventilation**

For more information on Auto Comfort Control, refer to the "Seat warmers" and "Air ventilation seats" section in chapter 3 and "Heated steering wheel" section in this chapter.

Smart ventilation

The smart ventilation system maintains pleasant/fresh air condition inside the passenger compartment by automatically detecting/controlling the temperature and humidity, when you drive the vehicle with the climate control system in the OFF position. When the smart ventilation system starts to operate, the message '**SMART VENTILATION ON**' appears for 5 seconds.

- The smart ventilation system stops operating, when the BLOWER DOWN OFF button of the climate control system is selected.
- The smart ventilation system stops operating, when any button of the climate control system is selected for operation.
- The smart ventilation system may not operate, when the vehicle is driven at low speed.

Storage compartment

WARNING

Never store cigarette lighters, propane cylinders, or other flammable/explosive materials in the vehicle. These items may catch fire and/or explode if the vehicle is exposed to hot temperatures for extended periods.

WARNING

ALWAYS keep the storage compartment covers closed securely while driving. Items inside your vehicle are moving as fast as the vehicle. If you have to stop or turn quickly, or if there is a crash, the items may fly out of the compartment and may cause an injury if they strike the driver or a passenger.

NOTICE

To avoid possible theft, do not leave valuables in the storage compartments.

Center console storage

Console Box



To open:

Grab and hold the latch on the arm rest then lift the lid.

- This space provides objects storing compartment.

Glove box

Type A

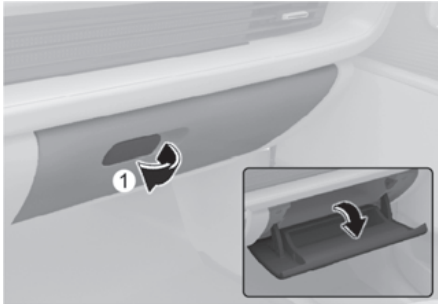

Type B



To open:
Pull the lever (1).

WARNING

ALWAYS close the glove box door after use.

An open glove box door can cause serious injury to the passenger in an accident, even if the passenger is wearing a seat belt.

NOTICE

Use of excessive force to the glove box may damage the sliding rail or the lever.

Interior features

Cup holder

Front

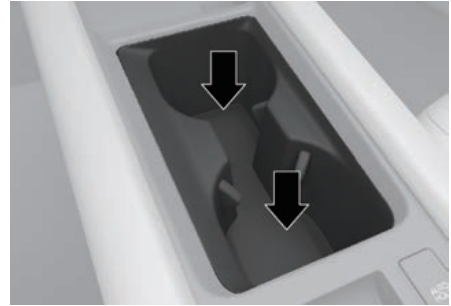

Rear



Cups or small beverages cups may be placed in the cup holders.

WARNING

- Avoid abrupt starting and braking when the cup holder is in use to prevent spilling your drink. If hot liquid spills, you could be burned. Such a burn to the driver could cause loss of vehicle control resulting in an accident.
- Do not place uncovered or unsecured cups, bottles, cans, etc., in the cup holder containing hot liquid while the vehicle is in motion. Injuries may result in the event of a sudden stop or collision.
- Only use soft cups in the cup holders. Hard objects can injure you in an accident.

WARNING

Keep cans or bottles out of direct sun light and do not put them in a hot vehicle. It may explode.

NOTICE

- Keep your drinks sealed while driving to prevent spilling your drink. If liquid spills, it may get into the vehicle's electrical/electronic system and damage electrical/electronic parts.
- When cleaning spilled liquids do not use hot air to blow out or dry the cup holder. This may damage the interior.

Sunvisor

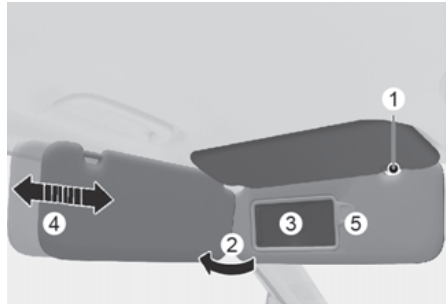

To use the sunvisor, pull it downward.

To use the sunvisor to block the sun from the side window, pull it downward, release it from the bracket (1) and swing it to the side (2) towards the window.

To use the vanity mirror, pull down the sunvisor and slide the mirror cover (3).

Adjust the sunvisor forward or backward (4) as needed (if equipped). Use the ticket holder (5) to hold tickets.

Close the vanity mirror cover securely and return the sunvisor to its original position after use.

WARNING

For your safety, do not block your view when using the sunvisor.

NOTICE

- The tab (5) adjacent to the vanity mirror on the sunvisor can be used for toll road tickets or self parking tickets. Use caution when inserting tickets into the ticket holder to avoid damage. Refrain from putting several tickets in the ticket holder as this could also damage the retaining tab.
- Always have the switch in the off position when the vanity mirror lamp is not in use. If the sunvisor is closed without the lamp off, it may discharge the battery or damage the sunvisor.

Power outlet

Front

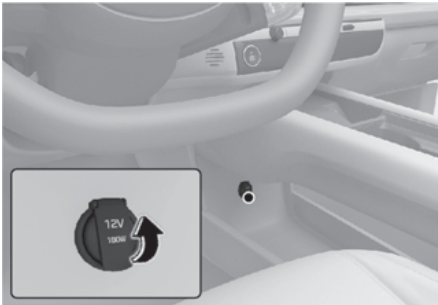

The power outlet is designed to provide power for mobile telephones or other devices designed to operate with vehicle electrical systems. The devices should draw less than 180 Watts with the vehicle running.

WARNING

Avoid electrical shocks. Do not place your fingers or foreign objects (pin, etc.) into a power outlet or touch the power outlet with a wet hand.

NOTICE

To prevent damage to the power outlets:

- Use the power outlet only when the vehicle is running and remove the accessory plug after use. Using the accessory plug for prolonged periods of time with the vehicle off could cause the battery to discharge.
- Only use 12 V electric accessories which are less than 180 Watts in electric capacity.
- Adjust the air-conditioner or heater to the lowest operating level when using the power outlet.
- Close the cover when not in use.
- Some electronic devices can cause electronic interference when plugged into a vehicle's power outlet. These devices may cause excessive audio static and malfunctions in other electronic systems or devices used in your vehicle.
- Push the plug in as far as it will go. If good contact is not made, the plug may overheat and the fuse may open.
- Plug in battery equipped electrical/electronic devices with reverse current protection. The current from the battery may flow into the vehicle's electrical/electronic system and cause system malfunction.

USB charger

 If equipped

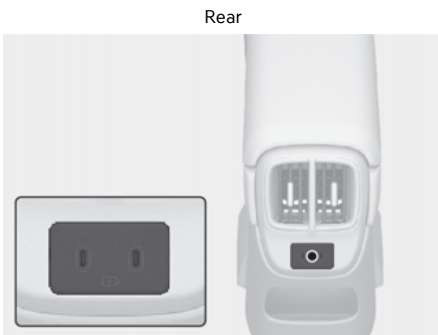
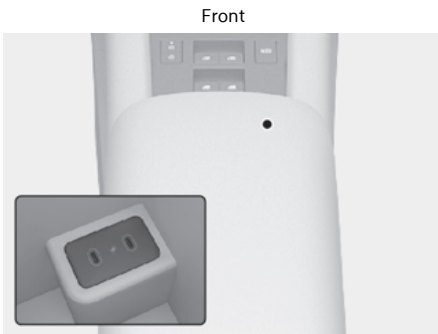

The USB charger is designed to recharge batteries of small size electrical devices using a USB cable.

The electrical devices can be recharged when the Start/Stop button is in the ON or START position.

The battery charging state may be monitored on the electrical device.

Disconnect the USB cable from the USB port after use.

- A smartphone or a tablet PC may get warmer during the re-charging process. It does not indicate any malfunction with the charging system.
- A smartphone or a tablet PC, which adopts a different re-charging method, may not be properly re-charged. In this case, use an exclusive charger of your device.
- The charging terminal is only to recharge a device. Do not use the charging terminal either to turn ON an audio or to play media In the infotainment system.

NOTICE

- Use the USB charger when the vehicle is running. Using the USB charger for prolonged periods of time with the vehicle off could cause the battery to discharge.
- To prevent damage to the USB charger:
- Do not insert foreign objects or spill liquid into the outlet. The USB charging terminal may be damaged.
- Do not use devices with current consumption exceeding 2,100 mA (2.1 A).

Wireless smartphone charging system

 if equipped

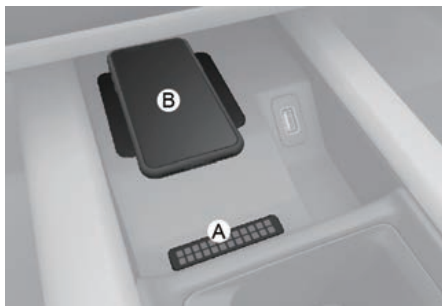

[A] Indicator light
[B] Charging pad

On certain models, the vehicle comes equipped with a wireless smartphone charger.

The system is available when all doors are closed, and when the Start/Stop button is in the ON or START position.

Charging smartphone

The wireless smartphone charging system charges only the Qi-enabled smartphones . Read the label on the smartphone accessory cover or visit your smartphone manufacturer's website to check whether your smartphone supports the Qi technology.

The wireless charging process starts when you put a Qi-enabled smartphone on the wireless charging unit.

1. Remove other items, including the smart key, from the wireless charging unit. If not, the wireless charging process may be interrupted. Place the smartphone on the center of the charging pad.
2. The indicator light is orange when the smartphone is charging. The indicator light will turn green when phone charging is complete.
3. You can turn ON or OFF the wireless charging function from the Settings menu in the infotainment system. Select:

Setup > Vehicle Settings > Convenience > Wireless Charging System for Mobile Devices

Information

- The infotainment system may change after software updates. For more information, refer to the manual provided in the infotainment system and the quick reference guide.
- For flip type smartphones, when using wireless charging, place the smartphone folded with the device's back placed on the center of the wireless charging unit.

If your smartphone is not charging:

- Slightly change the position of the smartphone on the charging pad.
- Make sure the indicator light is orange.

The indicator light will blink orange for 10 seconds if there is a malfunction in the wireless charging system.

In this case, temporarily stop the charging process, and re-attempt to charge your smartphone again.

The system warns you with a message on the cluster display if the smartphone is still on the wireless charging unit after the vehicle is turned OFF and the front door is opened.

For some manufacturer's smartphones, the system may not warn you even though the smartphone is left on the wireless charging unit. This is due to the particular characteristic of the smartphone and not a malfunction of the wireless charging.

NOTICE

- Smartphones that do not have wireless charging standard (Qi) certification, such as iPhones, may not charge normally.
 - When placing your smartphone on the charging pad, position the phone in the middle of the mat for optimal charging performance. If your smartphone is off to the side, the charging rate may be less and in some cases the smartphone may experience higher heat conduction.
 - In some cases, the wireless charging may stop temporarily when the smart key is used, either when starting the vehicle or locking/unlocking the doors, etc.
 - When charging certain smartphones, the charging indicator may not change to blue when the smartphone is fully charged.
 - The wireless charging process may temporarily stop, when temperature abnormally increases inside the wireless smartphone charging system. The wireless charging process restarts, when temperature falls to a certain level.
 - The wireless charging process may temporarily stop when there is any metallic item, such as a coin, between the wireless smartphone charging system and smartphone.
 - When charging some smartphones with a self-protection feature, the wireless charging speed may decrease and the wireless charging may stop.
 - If the smartphone has a thick cover, the wireless charging may not be possible.
 - If the smartphone is not completely contacting the charging pad, wireless charging may not operate properly.
 - Some magnetic items like credit cards, phone cards or rail tickets may be damaged if left with the smartphone during the charging process.
 - When any smartphone without a wireless charging function or a metallic object is placed on the charging pad, a small noise may sound. This small sound is due to the vehicle discerning compatibility of the object placed on the charging pad. It does not affect your vehicle or the smartphone in any way.
-

i Information

If the Start/Stop button is in the OFF position, the charging also stops.

Vehicle to load (V2L)

 if equipped



V2L (Vehicle to Load) is installed at the central rear seat. V2L is a convenient feature which provides enough electricity to use diverse household electrical appliances in the vehicle.

V2L is installed at the central rear seat bottom.

For more information, refer to the "Using V2L function" section in chapter 1.

Clock

The clock can be set from the infotainment system.

For more information, refer to the manual provided in the infotainment system and the quick reference guide.

WARNING

Do not attempt to adjust the clock while driving. Doing so may result in distracted driving which may lead to an accident involving personal injury or death.

Coat hook

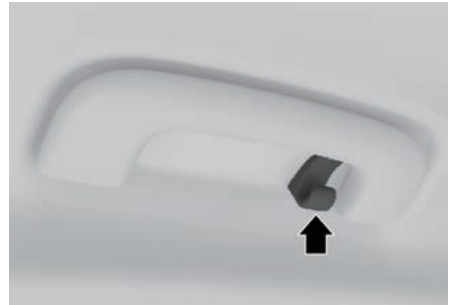

These hooks are not designed to hold large or heavy items.

! WARNING

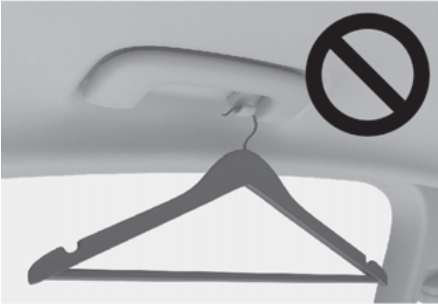

Do not hang other objects such as hangers or hard objects except clothes. Also, do not put heavy, sharp or breakable objects in the clothes pockets. In an accident or when the curtain airbag is inflated, it may cause vehicle damage or personal injury.

Floor mat anchor(s)

ALWAYS use the Floor Mat Anchors to attach the front floor mats to the vehicle. The anchors on the front floor carpet keep the floor mats from sliding forward.

! WARNING

Do not overlay additional mats or liners over the floor mats. If using All Weather mats, remove the carpeted floor mats before installing them. Only use floor mats designed to connect to the anchors.

! WARNING

The following must be observed when installing ANY floor mat to the vehicle.

- Ensure to remove a protective film attached on the carpet before attaching a floor mat on the front floor carpet. Otherwise, the floor mat may move freely on the protective film and it could result in unintentional braking or accelerating.
- Ensure that the floor mats are securely attached to the vehicle's floor mat anchor(s) before driving the vehicle.
- Do not use ANY floor mat that cannot be firmly attached to the vehicle's floor mat anchors.
- Do not stack floor mats on top of one another (for example, all-weather rubber mat on top of a carpeted floor mat). Only a single floor mat should be installed in each position.

IMPORTANT Your vehicle was manufactured with driver's side floor mat anchors that are designed to securely hold the floor mat in place. To avoid any interference with pedal operation, HYUNDAI Vehicle recommends that the HYUNDAI floor mat designed for use in your vehicle be installed.

Infotainment system

NOTICE

- If you install an aftermarket HID headlight, your vehicle's audio and electronic devices may not function properly.
- Prevent chemicals such as perfume, cosmetic oil, sun cream, hand cleaner, and air freshener from contacting the interior parts because they may cause damage or discoloration.

USB Port



You can use a USB cable to connect audio devices to the vehicle USB port.

i Information

When using a portable audio device connected to the power outlet, noise may occur during playback. If this happens, use the portable audio device's power source.

Antenna

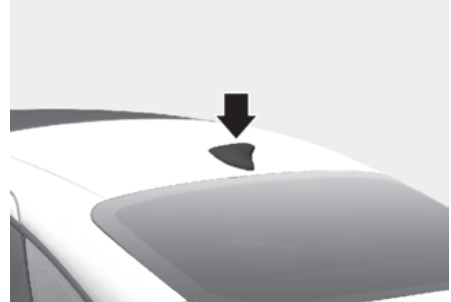

The shark fin antenna will receive AM, FM broadcast signals and transmit data.

Steering wheel remote controls

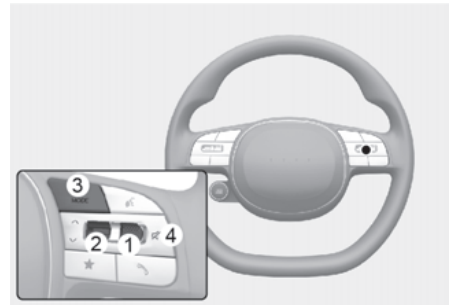

NOTICE

Do not operate multiple audio remote control buttons simultaneously.

VOLUME (VOL + / VOL -) (1)

- Rotate the VOLUME scroll up to increase volume.
- Rotate the VOLUME scroll down to decrease volume.

SEEK/PRESET (^ / v) (2)

If the SEEK/PRESET switch is pressed up or down and held for 0.8 second or more, it will function in the following modes:

- RADIO mode
It will function as the AUTO SEEK select button. It will SEEK until you release the button.
- MEDIA mode
It will function as the FF/RW button.

If the SEEK/PRESET switch is pressed up or down, it will function in the following modes:

- RADIO mode
It will function as the PRESET STATION UP/DOWN button.
- MEDIA mode
It will function as the TRACK UP/ DOWN button.

MODE (3)

Press the MODE button to toggle through Radio or AUX modes.

MUTE (🔇) (4)

Press and hold the volume button to mute or activate the sound.

i Information

The infotainment system may change after software updates. For more information, refer to the manual provided in the infotainment system and the quick reference guide.

Infotainment system



i Information

The infotainment system may change after software updates. For more information, refer to the manual provided in the infotainment system and the quick reference guide.

Voice recognition

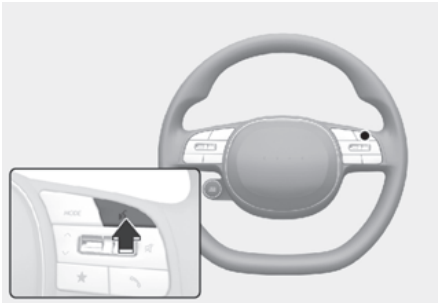

i Information

The infotainment system may change after software updates. For more information, refer to the manual provided in the infotainment system and the quick reference guide.

Bluetooth® Wireless Technology

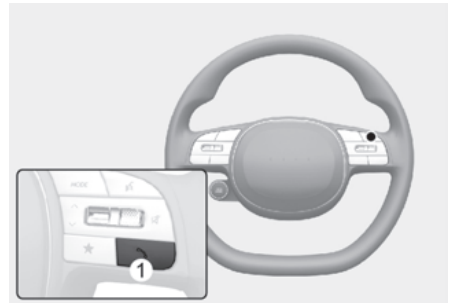

1. Call / Answer / Call end button
2. Microphone

i Information

The infotainment system may change after software updates. For more information, refer to the manual provided in the infotainment system and the quick reference guide.

! CAUTION

To avoid driver distractions, do not excessively operate the device while driving the vehicle which may lead to an accident.

6. Driving your vehicle

Before driving	6-3
Before entering the vehicle.....	6-3
Before starting	6-3
Start/Stop button	6-4
Start/Stop button positions.....	6-5
Starting the vehicle.....	6-6
Turning off the vehicle.....	6-7
Remote start.....	6-8
Reduction gear	6-9
Reduction gear operation	6-9
Cluster display messages.....	6-13
Good driving practices	6-14
Regenerative braking system (paddle shifter)	6-15
Using regenerative braking system.....	6-16
Regenerative braking system limitations.....	6-16
One Pedal Driving	6-17
Using i-PEDAL	6-18
Smart recuperation system	6-19
Smart recuperation system on/off	6-20
Smart recuperation system operating condition	6-20
Smart recuperation level settings.....	6-21
Pausing smart recuperation system.....	6-21
Front sensors (Front radar).....	6-22
System warning due to sensor problems.....	6-22
Precautions for smart recuperation system	6-23
Braking system	6-26
Power-assist brakes.....	6-26
Disc brakes wear indicator.....	6-27
Electronic Parking Brake (EPB).....	6-27
Auto Hold.....	6-32
Brake Disc Cleaning.....	6-35
Anti-lock Brake System (ABS).....	6-35
Electronic Stability Control (ESC).....	6-37
Vehicle Stability Management (VSM).....	6-40
Hill-Start Assist Control (HAC).....	6-41
Emergency Stop Signal (ESS).....	6-42

Multi-Collision Brake (MCB)	6-42
Brake Assistant System (BAS)	6-43
Good braking practices	6-44
All Wheel Drive (AWD)	6-44
Emergency precautions	6-47
Drive mode integrated control system (2WD)	6-48
Drive mode	6-48
Drive mode integrated control system (AWD)	6-51
Drive mode	6-51
Drive modes characteristic	6-54
Active air flap	6-55
Malfunction	6-55
Active sound design	6-56
Special driving conditions	6-56
Hazardous driving conditions	6-56
Rocking the vehicle	6-57
Smooth cornering	6-57
Driving at night	6-57
Driving in the rain	6-58
Driving in flooded areas	6-58
Highway driving	6-59
Winter driving	6-59
Snow or icy conditions	6-59
Winter precautions	6-63
Trailer towing	6-64
If you decide to pull a trailer	6-65
Trailer towing equipment	6-68
Driving with a trailer	6-69
Maintenance when towing a trailer	6-72
Vehicle weight	6-72
Overloading	6-73

Before driving

Before entering the vehicle

- Be sure all windows, outside mirror(s), and outside lights are clean and unobstructed.
- Remove frost, snow, or ice.
- Visually check the tires for uneven wear and damage.
- Check under the vehicle for any sign of leaks.
- Be sure there are no obstacles behind you if you intend to back up.

Before starting

- Make sure the hood, the trunk, and the doors are securely closed and locked.
- Adjust the position of the seat and steering wheel.
- Adjust the inside and outside rearview mirrors.
- Verify all the lights work.
- Fasten your seat belt. Check that all passengers have fastened their seat belts.
- Check the gauges and indicators in the instrument panel and the messages on the instrument display when the vehicle is in the ON position.
- Check that any items you are carrying are stored properly or fastened down securely.

WARNING

To reduce the risk of **SERIOUS INJURY** or **DEATH**, take the following precautions:

- **ALWAYS** wear your seat belt. All passengers must be properly belted whenever the vehicle is moving. For more information, refer to the "Seat belts" section in chapter 3.
- Always drive defensively. Assume other drivers or pedestrians may be careless and make mistakes.
- Stay focused on the task of driving. Driver distraction can cause accidents.
- Leave plenty of space between you and the vehicle in front of you.

WARNING

NEVER drink or take drugs and drive.

Drinking or taking drugs and driving is dangerous and may result in an accident and **SERIOUS INJURY** or **DEATH**.

Drunk driving is the number one contributor to the highway death toll each year. Even a small amount of alcohol will affect your reflexes, perceptions and judgment. Just one drink can reduce your ability to respond to changing conditions and emergencies and your reaction time gets worse with each additional drink.

Driving while under the influence of drugs is as dangerous or more dangerous than driving under the influence of alcohol.

You are much more likely to have a serious accident if you drink or take drugs and drive. If you are drinking or taking drugs, don't drive. Do not ride with a driver who has been drinking or taking drugs. Choose a designated driver or call a taxi.

Start/Stop button



Whenever the front door is opened, the Start/Stop button will illuminate and will go off 30 seconds after the door is closed.

WARNING

To turn the vehicle off in an emergency: Press and hold the Start/Stop button for more than two seconds OR Rapidly press and release the Start/Stop button three times (within three seconds).

If the vehicle is still moving, you can restart the vehicle without depressing the brake pedal by pressing the Start/Stop button with the gear in the N (Neutral) position.

WARNING

- NEVER press the Start/Stop button while the vehicle is in motion except in an emergency. This will result in the vehicle turning off and loss of power assist for the steering and brake systems. This may lead to loss of directional control and braking function, which could cause an accident.
- Before leaving the driver's seat, always make sure the gear is in the P (Park) position, set the parking brake, press the Start/Stop button to the OFF position, and take the Smart Key with you. Unexpected vehicle movement may occur if these precautions are not followed.
- NEVER reach through the steering wheel for the Start/Stop button or any other control while the vehicle is in motion. The presence of your hand or arm in this area may cause a loss of vehicle control resulting in an accident.

Start/Stop button positions

Button Position	Action	Notes
OFF	To turn off the vehicle, press the Start/Stop button with the vehicle shifted to P (Park). If the Start/Stop button is pressed with the vehicle shifted to D (Drive), R (Reverse) or N (Neutral), the gear automatically shifts to P (Park).	If the steering wheel is not locked properly when you open the driver's door, the warning chime will sound.
ACC	Press the Start/Stop button when the button is in the OFF position without depressing the brake pedal. Some of the electrical accessories are usable. The steering wheel unlocks.	<ul style="list-style-type: none"> • If you leave the Start/Stop button in the ACC position for more than one hour, the battery power will turn off automatically to prevent the battery from discharging. • If the steering wheel doesn't unlock properly, the Start/Stop button will not work. Press the Start/Stop button while turning the steering wheel right and left to release.
ON	Press the Start/Stop button while it is in the ACC position without depressing the brake pedal. The warning lights can be checked before the vehicle is started.	Do not leave the Start/Stop button in the ON position when the vehicle is not running to prevent the battery from discharging.
START	To start the vehicle, depress the brake pedal and press the Start/ Stop button with the gear shifted to the P (Park) position.	If you press the Start/Stop button without depressing the brake pedal, the vehicle does not start and the Start/Stop button changes as follows: OFF > ACC > ON > OFF or ACC

i Information

To prevent vehicle battery discharge, the Start/Stop button changes to the OFF position when the Start/Stop button is in the ACC or ON position with the gear in P (Park) for a certain period of time. When the function operates, the tail lights will turn off. To use the tail lights again, turn the headlight switch located on the steering column to the OFF and ON position again.

Starting the vehicle

WARNING

- Always wear appropriate shoes when operating your vehicle. Unsuitable shoes, such as high heels, ski boots, sandals, flipflops, etc., may interfere with your ability to use the brake and accelerator pedals.
 - Do not start the vehicle with the accelerator pedal depressed.
The vehicle can move which can lead to an accident.
-

Information

- The vehicle will start by pressing the Start/Stop button, only when the smart key is in the vehicle.
 - Even if the smart key is in the vehicle, and when it is far away from the driver, the vehicle may not start.
 - When the Start/Stop button is in the ACC or ON position, if any door is open, the system checks for the smart key. When the smart key is not in the vehicle, the " " indicator will blink and the warning 'Key not in vehicle' will come on. When all doors are closed, the chime will also sound for about 5 seconds. Keep the smart key in the vehicle when in the ACC position or if the vehicle is in the ready (READY) mode.
-

Starting the vehicle

1. Always carry the smart key with you.
2. Make sure the parking brake is applied.
3. Make sure the gear is in P (Park).
4. Depress the brake pedal.
5. Press the Start/Stop button. If the vehicle starts, the "READY" indicator will come on.

Information

- Always start the vehicle with your foot on the brake pedal. Do not depress the accelerator while starting the vehicle. Do not race the motor while warming it up.
 - If ambient temperature is low, the " " indicator may remain illuminated longer than the normal amount of time.
-

NOTICE

To prevent damage to the vehicle:

- If the (READY) indicator turns off while you are in motion, do not attempt to shift the gear to the P (Park) position.
If traffic and road conditions permit, you may put the gear in N (Neutral) while the vehicle is still moving and press the Start/Stop button in an attempt to restart the vehicle.
 - Do not push or tow your vehicle to start the vehicle.
-

NOTICE

To prevent damage to the vehicle:

Do not press the Start/Stop button for more than 10 seconds except when the stop light fuse is blown.

When the stop light fuse is blown, you cannot normally start the vehicle. Replace the fuse with a new one. If you are not able to replace the fuse, you can start the vehicle by pressing and holding the Start/Stop button for 10 seconds with the Start/Stop button in the ACC position.

Pressing the brake pedal many times while "READY" indicator light is off will increase the possibility of discharging the 12 V battery.

For your safety always depress the brake pedal before starting the vehicle.

i Information

Virtual Engine Sound System(VESS)

VESS generates virtual engine sound to make pedestrians to aware. VESS operates when the vehicle can be driven. When the vehicle in P (Park) gear status, VESS doesn't work.

! CAUTION

- Because the vehicle doesn't make the engine sound, pay attention to the surrounding environment and drive carefully.
- After parking or waiting for a traffic light, please check around (children, obstacle, etc.) before departure.
- When reversing, check directly behind you before driving. Pedestrians may not be able to recognize vehicle sounds.

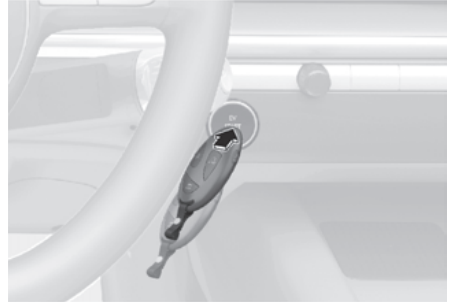
Emergency starting

If the smart key battery is weak or the smart key does not work correctly, you can start the vehicle by pressing the Start/Stop button with the smart key in the direction of the picture above.

Turning off the vehicle

1. Stop the vehicle and depress the brake pedal fully.
2. Shift to P (Park).
3. Press the Start/Stop button to the OFF position and apply the parking brake.
4. Make sure the "READY" indicator light is off in the instrument cluster.

! CAUTION

If the "READY" indicator light on the instrument cluster is still on, the vehicle is not turned off and can move when the gear is in any position except P (Park).

Remote start

Type A



Type B



- The vehicle will not remotely start if the hood or trunk is opened.
- The vehicle must be in P (Park) for the remote start function to start.
- The vehicle turns off if you get in the vehicle without a registered smart key.
- The vehicle turns off if you do not get in the vehicle within 10 minutes after remotely starting the vehicle.

You can start the vehicle using the Remote Start button of the smart key.

To start the vehicle remotely:

1. Press the door lock button within 10 m (32 ft.) from the vehicle.
 2. Press the remote start (🔄) button for over 2 seconds within 4 seconds after locking the doors.
 3. To turn off the remote start function, press the remote start (🔄) button once.
- The remote start (🔄) button may not operate if the smart key is not within 10 m (32 ft.).

Reduction gear

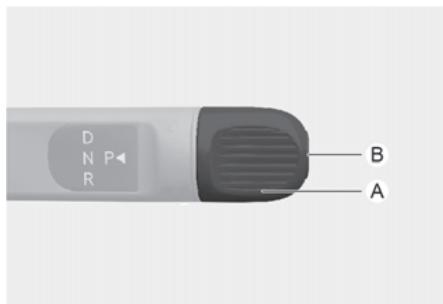

[A] Rotary gear shift dial
[B] P button

Reduction gear operation

To change the gear, depress the brake pedal and rotate the rotary gear shift dial.

WARNING

To reduce the risk of serious injury or death:

- ALWAYS check the surrounding areas near your vehicle for people, especially children, before shifting a vehicle into D (Drive) or R (Reverse).
- Before leaving the driver's seat, always make sure the vehicle is shifted to the P (Park) position, then apply the parking brake, then press the Start/Stop button to the OFF position. Unexpected and sudden vehicle movement can occur if these precautions are not followed.

Rotary shifter/ Rotary gear shift dial

P (Park)

Always come to a complete stop before shifting into P (Park).



To shift the gear to P (Park), press the P button while depressing the brake pedal. If you turn the vehicle off in R (Reverse), N (Neutral) or D (Drive), the gear will automatically shift to P (Park).

WARNING

- Shifting into P (Park) while the vehicle is in motion may cause you to lose control of the vehicle.
- After the vehicle has stopped, always make sure the vehicle is in P (Park), apply the parking brake, and turn the vehicle off.
- When parking on an incline, shift the gear to P (Park) and apply the parking brake to prevent the vehicle from rolling downhill.

i Information

For vehicles equipped with the Electronic Parking Brake (EPB), EPB applies automatically when the gear is shifted to P (Park).

Automatic gear shift to P (Park)

The gear is shifted to P (Park) automatically for safety reasons under the following conditions:

- When the vehicle is turned off with the gear in R (Reverse), D (Drive) or N (Neutral).
- When the driver's door is open with the vehicle running, the gear in R (Reverse), D (Drive) or N (Neutral), and the vehicle at a standstill.
- When the driver's door is open with the gear in N (Neutral) and the vehicle is off.

In situations the gear must be in P (Park), always check if the gear is shifted to P (Park) by checking the instrument cluster.

R (Reverse)

Use this position to drive the vehicle rearward.

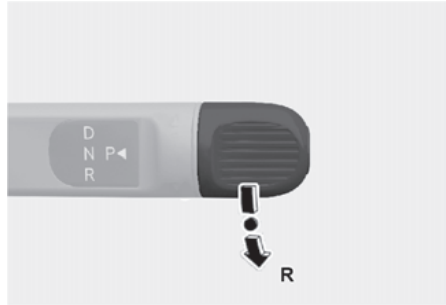

To shift the gear to R (Rear), rotate the rotary gear shift dial to R (Reverse) while depressing the brake pedal.

When the vehicle is stopped in the R (Reverse) position, if you open the driver's door, the gear will automatically shift to P (Park).

However, if the vehicle is in motion, the gear may not automatically shift to P (Park) to prevent reduction gear damage.

The direction of the rotary gear shift dial is the same as that of the wheel.

NOTICE

Always come to a complete stop before shifting into or out of R (Reverse); you may damage the reduction gear if you shift into R (Reverse) while the vehicle is in motion.

N (Neutral)

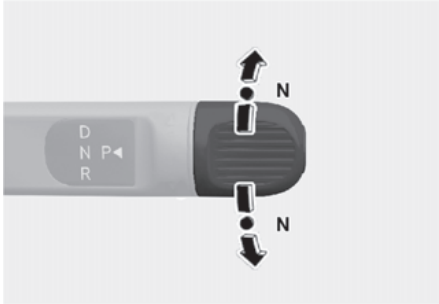

To shift the gear to N (Neutral), rotate the rotary gear shift dial to N (Neutral) while depressing the brake pedal.

Always depress the brake pedal when you are shifting from N (Neutral) to another gear.

If you turn the vehicle off in N (Neutral), the gear will automatically shift to P (Park).

However, if you need to stay in N (Neutral) with the vehicle off, refer to the "To stay in N (Neutral) when vehicle is OFF" section in the following description.

To rotate the rotary gear shift dial to N (Neutral), rotate the rotary gear shift dial once clockwise or counterclockwise.

If the current gear position is in D (Drive), rotate the rotary gear shift dial counterclockwise. When the gear position is in R (Reverse), rotate the rotary gear shift dial clockwise.

To stay in N (Neutral) when vehicle is OFF

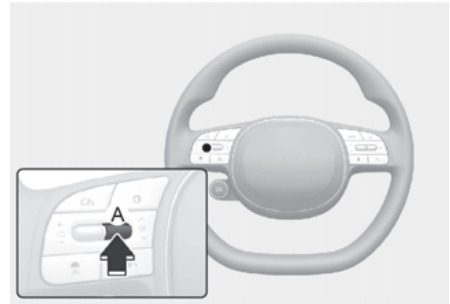
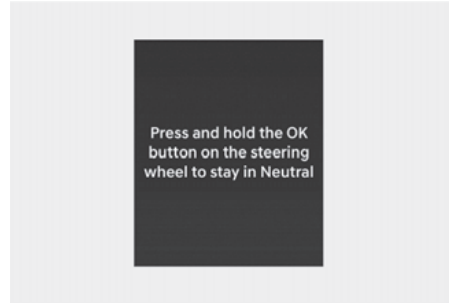

[A] OK button

If you want to stay in N (Neutral) after the vehicle is in the ACC state, do the following.

1. Turn off Auto Hold and release Electronic Parking Brake when the vehicle is running.
2. Rotate the shift to N (neutral) while depressing the brake pedal.
3. When you take your foot off the brake pedal, the message **'Press and hold OK button on the steering wheel to stay in Neutral'** will appear on the cluster display.

4. Press and hold the OK button on the steering wheel for more than 1 second.
5. When the message **'Vehicle will stay in (N). Change gear to cancel'** (or **'N will stay engaged when the vehicle is Off'**) will appear on the cluster display, press the Start/Stop button while depressing the brake pedal.

However, if you open the driver's door within 3 minutes in the ACC state, the gear will automatically shift to P (Park) and the Start/Stop button will change to the OFF position.

NOTICE

- With the gear in N (Neutral) the Start/Stop button will be in the ACC position. Note that the doors cannot be locked in the ACC position or the battery (12 V) may discharge if left in the ACC position for a long period.
- Before entering an automatic car wash, release the Electronic Parking Brake (EPB) manually. If EPB is applied, it may damage the vehicle or automatic car wash.

i Information

When the Electronic Parking Brake (EPB) is applied, press the EPB switch while depressing the brake pedal. The Electronic Parking Brake (EPB) must be released manually because EPB does not release automatically even though the gear is shifted to N (Neutral).

D (Drive)

This is the normal driving position.

The reduction gear automatically activates the regenerative braking system according to the road conditions.

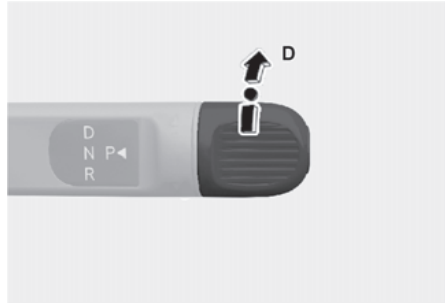

To shift the gear to D (Drive), rotate the rotary gear shift dial to D (Drive) while depressing the brake pedal.

When the vehicle is stopped in the D (Drive) position, if you open the driver's door, the gear will automatically shift to P (Park).

However, if the vehicle is in motion, the gear may not automatically shift to P (Park) to prevent reduction gear damage.

NOTICE

Always come to a complete stop before shifting into D (Drive).

CAUTION

When you start after stopping on a steep incline, even if the gear is in D (Drive), if you do not depress the accelerator or brake pedal, the vehicle may roll backwards, which can cause an accident.

Shift-lock system

For your safety, your vehicle has a shift-lock system which prevents shifting the gear from P (Park) or N (Neutral) into R (Reverse) or D (Drive) unless the brake pedal is depressed.

To shift from P (Park) or N (Neutral) into R (Reverse) or D (Drive), from R (Reverse) into D (Drive) or from D (Drive) into R (Reverse):

1. Depress and hold the brake pedal.
2. Start the vehicle.
3. Shift the gear in R (Reverse) or D (Drive).

i Information

The gear cannot be shifted while the charging cable is connected.

When the battery (12 V) is discharged

You cannot shift gears, when the battery is discharged.

Jump start your vehicle (refer to the "Jump starting (12 V battery)" section in chapter 8 or we recommend that you contact an authorized HYUNDAI dealer.

Parking

Always come to a complete stop and continue to depress the brake pedal. Shift the gear to P (Park), apply the parking brake, and press the Start/Stop button to the OFF position. Take the Key with you when leaving the vehicle.

Cluster display messages

Press brake pedal to change gear

This message is displayed when the brake pedal is not depressed while shifting the gear.

Depress the brake pedal and then shift the gear.

Shift to P after stopping

This message is displayed when the gear is shifted to P (Park) while the vehicle is moving.

Stop the vehicle before shifting to P (Park).

Shifter system malfunction

This message is displayed when the shift gear does not properly operate in the P (Park) position.

We recommend that you have the vehicle inspected by an authorized HYUNDAI dealer.

Check shifter dial

This message is displayed when there is a malfunction with the rotary gear shift dial.

We recommend that you have the vehicle inspected by an authorized HYUNDAI dealer.

Check P button

This message is displayed when there is a problem with the P (Park) button.

We recommend that you have the vehicle inspected by an authorized HYUNDAI dealer.

Rotary shifter stuck

This message is displayed when the rotary gear shift dial does not return back to its normal position after rotating it.

We recommend that you have the vehicle inspected by an authorized HYUNDAI dealer.

Good driving practices

- Never shift the gear from P (Park) or N (Neutral) to any other position with the accelerator pedal depressed.
- Never shift the gear into P (Park) when the vehicle is in motion.
Be sure the vehicle is completely stopped before you attempt to shift into R (Reverse) or D (Drive).
- Do not shift the gear to N (Neutral) when driving. If the gear is shifted to N (Neutral) while driving. Doing so may increase the risk of an accident.
Also, shift the gear back to D (Drive) while the vehicle is moving may severely damage the reduction gear.

- When driving uphill or downhill, always shift to D (Drive) for driving forward or shift to R (Reverse) for driving rearwards. After selecting D (Drive) or R (Reverse), check the gear position indicated on the instrument cluster before driving. If the vehicle moves in the opposite direction of the selected gear, the vehicle may turn off and a serious accident might occur due to degraded brake performance.
- Do not drive with your foot resting on the brake pedal. Even light, but consistent pedal pressure can result in the brakes overheating, brake wear and possibly even brake failure.
- Always apply the parking brake when leaving the vehicle. Do not depend on placing the shift gear in P (Park) to keep the vehicle from moving.
- Exercise extreme caution when driving on a slippery surface. Be especially careful when braking, accelerating or shifting gears. On a slippery surface, an abrupt change in vehicle speed can cause the drive wheels to lose traction and may cause loss of vehicle control resulting in an accident.
- Optimum vehicle performance and economy is obtained by smoothly depressing and releasing the accelerator.

⚠ WARNING

To reduce the risk of **SERIOUS INJURY** or **DEATH**:

- **ALWAYS** wear your seat belt. In a collision, an unbelted occupant is significantly more likely to be seriously injured or killed than a properly belted occupant.
 - Avoid high speeds when cornering or turning.
 - Do not make quick steering wheel movements, such as sharp lane changes or fast, sharp turns.
 - The risk of rollover is greatly increased if you lose control of your vehicle at highway speeds.
 - Loss of control often occurs if two or more wheels drop off the roadway and the driver over steers to reenter the roadway.
 - In the event your vehicle leaves the roadway, do not steer sharply. Instead, slow down before pulling back into the travel lanes.
 - **HYUNDAI** Vehicle recommends you to follow all posted speed limits.
-

Regenerative braking system (paddle shifter)

Regenerative braking system operates the paddle shift lever to control the regenerative braking intensity of the vehicle. It improves the energy efficiency of the vehicle and helps the driver to have a better driving experience.

***i* Information**

The regenerative braking system uses the electric motor to engage the brake. The electric motor converts the kinetic energy generated from decelerating the vehicle to electricity and charges the high voltage battery.

Using regenerative braking system

Operating paddle shift lever

Operate the paddle shift lever as shown below to use the regenerative braking system.



- Pull the left paddle shift (+) once to raise the regenerative braking intensity level by 1. It will increase decelerating intensity.
- Pull the right paddle shift (-) once to lower the regenerative braking intensity level by 1. It will decrease decelerating intensity.
- Pull and hold the left paddle shift (+) for over 0.5 seconds to keep raising the regenerative braking intensity level. Keeping hold of the paddle shift will bring the vehicle to stop. (For more information, refer to the "One Pedal Driving" section in this chapter.)
- (While the smart recuperation system is turned on) Pull and hold the right paddle (-) shift for over 1 second to turn off the smart recuperation system. (For more information, refer to the "Smart recuperation system" section in this chapter.)

Checking the amount of regenerative braking



The selected regenerative braking level is displayed on the instrument cluster. When the vehicle is turned off and on again after the regenerative braking level is lowered to 0, the braking level will change to 1.

Regenerative braking system limitations

Regenerative braking intensity cannot be changed using the paddle shift lever in the following situations:

- When the (+) and (-) paddle shift levers are pulled at the same time.
- When the vehicle is decelerating by depressing the brake pedal.
- When Smart Cruise Control is activated.
- When regenerative braking is continuously operated with the battery fully charged
- When the SNOW mode is activated

Initial setting of the regenerative braking level and adjustable range vary according to the selected Drive mode.

Drive mode	Adjustable Range
SNOW	0 to 1
ECO	0 to 3
NORMAL	0 to 3
SPORT	0 to 3

For more information, refer to the "Drive mode integrated control system (2WD)" or "Drive mode integrated control system (AWD)" section in this chapter.

One Pedal Driving

One pedal driving operates the paddle shift lever while coasting to control the intensity of regenerative braking. It assists the driver to stop the vehicle without depressing the brake.

i Information

Coasting is the process of driving a vehicle without the brake pedal and the accelerator depressed. Coasting uses the inertia of driving energy instead of the vehicle power.

Using one pedal driving

Pull and hold the left paddle shift lever (➡) for over 0.5 seconds while coasting to enable the one pedal driving mode.

- Release the paddle shift lever when the vehicle speed is above 3 km/h to return to the previously set regenerative braking level.
- If the vehicle speed is below 3 km/h, the vehicle will keep engaging the brake although the driver releases the paddle shift lever.
- Releasing the paddle shift lever after the vehicle comes to a stop will maintain the vehicle stationary.

CAUTION

- The vehicle may not come to a stop although the one pedal driving function is active, depending on the condition of the vehicle and the road. Check the surroundings and depress the brake pedal to decelerate.
- If the driver depresses the accelerator while pulling and holding the left paddle shift lever (➡) to increase the braking level, one pedal driving function will work like i-PEDAL function. In this case, the vehicle speed is no longer controllable through the paddle shift lever.

One pedal driving limitations

In the following conditions, the vehicle may not come to a stop although the one pedal driving function is active. Depress the brake pedal to stop the vehicle.

- When driving on a slope, or when the vehicle is repeatedly driven and stopped
- When the vehicle is driving through the end of the slope
- When driving on a slippery surface such as an icy, rainy, or muddy road
- When the wheels are not properly aligned
- When a wheel slip or wheel spin occurs
- When the weight on board is too heavy
- When the vehicle is tilted to one side
- When the tire is worn out too much

Automatic engagement of EPB

Use one pedal driving function to bring the vehicle to a stop and automatically engage the electronic parking brake (EPB).

After the vehicle is stopped, EPB is automatically engaged when any of the following conditions are satisfied

- The driver's seatbelt is unfastened and the driver's door is open.
- The gear shifts to N (Neutral).
- The hood is open.
- The trunk is open.
- 5 minutes have passed after the vehicle has stopped.
- One pedal driving is limited due to other reasons.

Using i-PEDAL

i-PEDAL assists the driver to accelerate, decelerate, and stop the vehicle with only the accelerator pedal.

Turning on/off the i-PEDAL

- Turning on i-PEDAL:

Pull the left paddle shift lever () once when the regenerative braking level is at 3. i-PEDAL is turned on and the instrument cluster displays the 'i-PEDAL' message. i-PEDAL is not available while the smart recuperation system is ON. Turn off the smart recuperation system first before using i-PEDAL.

- Turning off i-PEDAL:

Pull the right paddle shift lever () once while the function is ON. Otherwise, shift the gear to R (reverse) then to D (drive) while the function is ON. i-PEDAL is disabled and regenerative braking level is set to 3.

CAUTION

- Depending on the vehicle and road condition, the vehicle may not come to a stop although the i-PEDAL function is active. Check for the surroundings and depress the brake pedal to control the vehicle speed.
 - Do not use i-PEDAL on slippery roads.
-

***i*-PEDAL limitations**

In the following conditions, the vehicle may not come to a stop although the *i*-PEDAL is properly activated. Depress the brake to stop the vehicle.

- When driving on a slope, or when the vehicle is repeatedly driven and stopped
- When the vehicle is driving through the end of the slope
- When driving on a slippery surface such as an icy, rainy, or muddy road
- When the wheels are not properly aligned
- When a wheel slip or wheel spin occurs
- When the weight on board is too heavy
- When the vehicle is tilted to the side
- When the tire is worn out too much

Smart recuperation system

The smart recuperation system recognizes vehicle-to-vehicle distance, road gradient, and speed cameras and controls the regenerative braking level while coasting. It reduces unnecessary depressing of pedals to improve energy efficiency and driver convenience.

***i* Information**

- Coasting is the process of driving a vehicle without the brake pedal and the accelerator depressed. Coasting uses the inertia of driving energy instead of the vehicle power.
 - The regenerative braking system uses the electric motor to engage the brake. The electric motor converts the kinetic energy generated from decelerating the vehicle to electricity and charges the high voltage battery.
-

Smart recuperation system on/off

Operate the paddle shift lever as shown below to use the smart recuperation system.

- Turning on the smart recuperation system: While the READY indicator is ON, shift the gear to D (drive), and pull and hold the right paddle shift lever (➡) for over a second.

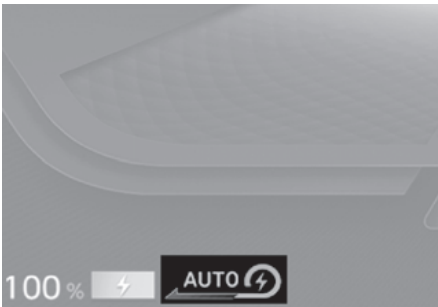

The smart recuperation system is ON and the regenerative braking level is displayed as AUTO.

- Turning off the smart recuperation system: While the smart recuperation system is ON, pull and hold the right paddle shift lever (➡) for over a second. The instrument cluster will display the regenerative braking level instead of 'AUTO', and the smart recuperation system will turn off.
- Using one pedal driving: While the smart recuperation system is ON, pull and hold the left paddle shift lever (⬅) for over 0.5 seconds (For more information, refer to the "One Pedal Driving" section in this chapter.)
i-PEDAL is not available while the smart recuperation system is ON. Turn off the smart recuperation system first before using i-PEDAL.

Smart recuperation system operating condition

When the regenerative braking level is displayed as AUTO and the vehicle speed is above 10 km/h (6 mph), the system will automatically control the regenerative braking level under the following conditions.

- The road gradient changes
- Distance from the vehicle ahead reduces or increases
- Speed of the vehicle ahead reduces or increases

! CAUTION

- When the forward safety warning light is ON, the smart recuperation system does not work properly. Depress the brake pedal for deceleration.
- The function that adjusts the regenerative braking intensity depending on the road gradient is only effective when the regenerative braking level is 0. Braking intensity does not significantly change depending on the road gradient if the regenerative braking level is 1 or above.

Smart recuperation level settings



The instrument cluster displays 'AUTO' (1) when the smart recuperation system is ON. Depending on the conditions, the system adjusts the regenerative braking level (2). The sky blue indicator light (3) illuminates when the vehicle recognizes a vehicle.

Smart recuperation default setting

The default braking level of the smart recuperation system can be changed. Set the default braking level to the lowest and let the system adjust the braking intensity automatically.

To change the default level of the smart recuperation system, pull the right paddle shift lever () once while the system is ON.

Smart recuperation intensity setting

Regenerative braking intensity of the smart recuperation system can be adjusted to match the driver's preference. Adjust the braking intensity makes the decelerating faster or slower.

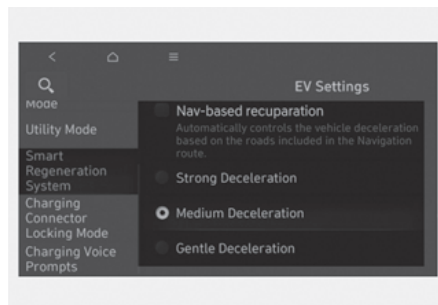

To adjust the regenerative braking level of the smart recuperation system, go to **Settings (Setup) > EV > Smart recuperation (Smart regeneration system)** from the infotainment system.

Pausing smart recuperation system

The smart recuperation system is temporarily turned off in the following conditions. While the system is turned off, the driver must keep eyes on the surroundings and depress the brake pedal to decelerate.

- The gear is shifted to N (Neutral), R (Reverse) or P (Park)
- Smart Cruise Control is ON
- ESC (Electronic Stability Control) is operating
- ABS is operating

Front sensors (Front radar)

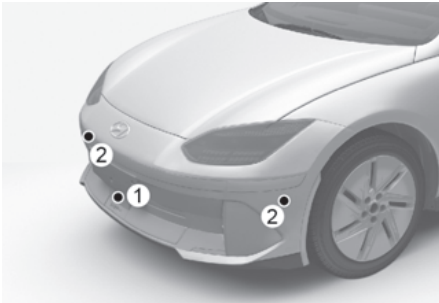

- (1) Front radar
- (2) Front corner radar

Front sensors recognize the distance from the vehicle ahead to control the regenerative braking intensity. If the sensor is covered with snow, rain, or other foreign substances, the performance of the sensors may deteriorate, and the smart recuperation system may turn off. Always keep the sensors clean.

System warning due to sensor problems

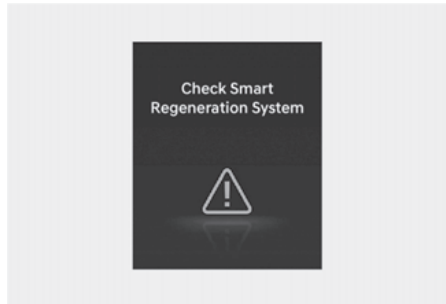

If the smart recuperation system is turned off due to the front sensors being covered with the foreign substances or due to other causes, the above warning message is displayed. Also the regenerative braking level is displayed instead of 'AUTO'.

Remove foreign substances from the sensors and turn on the system again by pulling and holding the right paddle shift lever (☞) for over a second.

If the warning message is still displayed after the sensors are cleaned, we recommend that you visit an authorized HYUNDAI dealer for inspection.

Precautions for smart recuperation system

The smart recuperation system is only for the driver's convenience and not a safety feature. The smart recuperation system neither completely engages the brake nor automatically avoids collisions. The driver must safely drive and operate the vehicle with his/her own decision although the system is turned on.

The smart recuperation system may not work properly if the system has difficulties recognizing the road condition due to the road condition due to congested traffic or deformed road shape. Always keep the safety distance while driving, and depress the brake pedal for deceleration.

Keep the following instructions for safe and efficient use of the smart recuperation system.

General precautions

- Always keep the safety distance from the vehicle ahead, and secure braking distance.
- Always prepare for unexpected situations and depress the brake pedal to decelerate when necessary. The smart recuperation system cannot react to pedestrians, vehicles making a sudden stop and vehicles coming from the opposite lane.
- If the vehicle ahead frequently changes the lane, keep your eyes forward to be prepared for hazardous situations. In this case, the smart recuperation system may respond late and may inappropriately respond to vehicle movements from the side lanes.
- The driver must depress the brake pedal when stopping the vehicle.
- Depress the brake pedal to decelerate in the following conditions.
 - When the front part of the vehicle is lifted up because of the cargo loaded on the rear part of the vehicle.
 - When the driver is operating the steering wheel.
 - When the vehicle is not driving in the center of the lane.
 - When the vehicle is driving on a that is too narrow or too curved.
- The smart recuperation system may be temporarily turn off when exposed to strong electromagnetic waves.
- If the vehicle starts coasting near the speed camera and engages the brake with the smart recuperation system, the vehicle may not be able to keep the speed limit. Always comply with the road and traffic law.

Precautions for front sensors

- Make sure that no physical impact is applied to the sensor or its surroundings. If the sensor is dislocated due to the shock, the system may not work properly and the instrument cluster may not display any warnings. If the sensor is exposed to physical impacts, we recommend that you visit an authorized HYUNDAI dealer for inspection.
- The sensors and its surroundings, the sensor covers, and the vehicle grille should always be kept clean.
- Do not attach any accessories such as molding or stickers on the sensor and its detection range, or change the vehicle grille. It may affect sensor performance.
- Always use genuine parts for the sensor cover, and do not paint it.
- Use soft fabric to prevent damage to the sensor cover when washing the car.
- Do not directly spray the sensor behind the grille with high pressured water when washing the car.

Precautions for vehicle recognition

- The front sensors may suddenly recognize the foregoing vehicle when the smart recuperation system reacts slowly, or the vehicle is going through the end of a slope or curve. In this case, the regenerative braking intensity is increased and the vehicle may slow down.

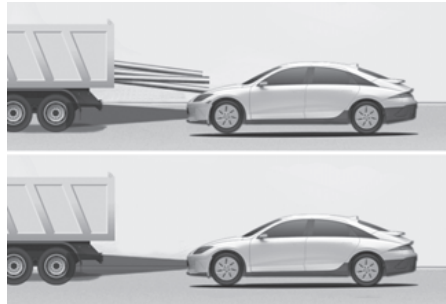

- The front sensors may be unable to recognize the vehicle ahead in the following situations even if it is on the same lane.
 - Narrow vehicles such as motorcycles or bicycles
 - Vehicles offset to one side
 - Slow-moving vehicles or sudden decelerating vehicles
 - Vehicles with small rear profile such as trailers with no loads
- When the vehicle in front of the foregoing vehicle is at a stop and the foregoing vehicle changes the lane, the front sensors may be unable to recognize the stopped vehicle.

Precautions on the curves

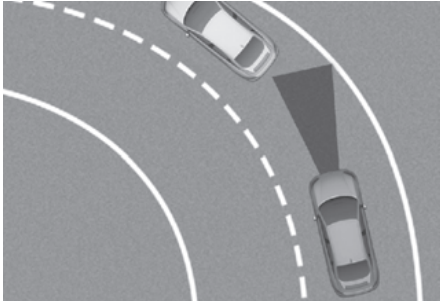

- The front sensors may be unable to recognize the foregoing vehicle if you are coasting on a curve. The regenerative braking intensity may automatically be lowered, which may accelerate the vehicle.

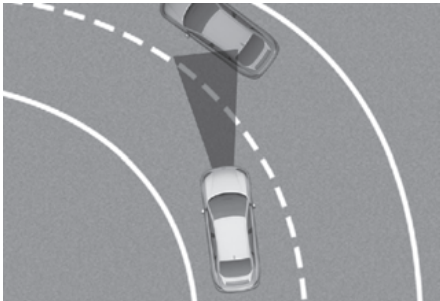

- On a curved road, the front sensors may recognize the vehicles on the other lane as the foregoing vehicle of the same lane. It may increase the regenerative braking intensity and the vehicle may decelerate. Check the surroundings and depress the accelerator to prevent unnecessary reduce of speed.
- If the front sensors suddenly recognize the vehicle ahead, regenerative braking intensity may rise and the vehicle may decelerate.

Precautions on the slope

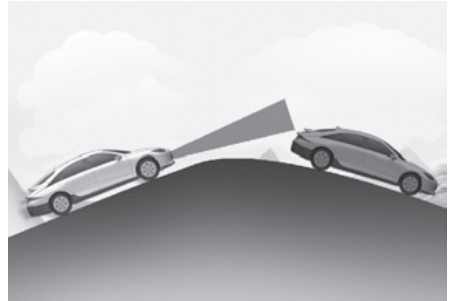

- When the vehicle is coasting through the end of a slope or where the gradient is changing, the front sensors may be unable to recognize, or may suddenly recognize the vehicle ahead. It may adjust the regenerative braking intensity and change the vehicle speed.
- When driving up or down the slope, check for the surroundings and depress the brake pedal to decelerate.

Precautions for shifting lanes

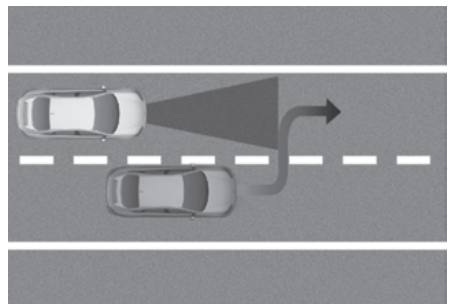

- If a vehicle on the next lane is moving into the front of your vehicle, the front sensors can only recognize the vehicle when it is completely inside the detection range.
- The front sensors may recognize the vehicles late that intervene suddenly.

Braking system

Power-assist brakes

Your vehicle has power-assisted brakes that adjust automatically through normal usage.

In the event of a vehicle power failure, the power assist for the brakes will not work. You can still stop your vehicle, but it will require greater force and increased pedal travel than normal. The stopping distance, however, will be longer than with power brakes.

i Information

- When the brake pedal is depressed under certain driving conditions or weather conditions, you may temporarily hear a noise. This is normal and does not indicate a problem with your brakes.
 - While driving on a road with deicing chemicals, brake noise or abnormal tire wear may occur due to deicing chemicals. In a safe traffic condition, additionally apply the brakes to remove deicing chemicals on the brake discs and pads.
-

! WARNING

Take the following precautions:

- Do not drive with your foot resting on the brake pedal. This will create abnormal high brake temperatures, excessive brake lining and pad wear, and increased stopping distances. So increase the regeneration braking level with the left paddle shift lever(+) to decrease the speed.
 - When descending down a long or steep hill, use the paddle shifter to increase the regeneration braking level in order to decrease your speed without using the brake pedal excessively. Applying the brakes continuously will cause the brakes to overheat and could result in a temporary loss of braking performance.
 - Wet brakes may impair the vehicle's ability to safely decelerate. Because wet brakes increase braking distance and cause noise troubles, select 0 step of the regenerative braking system and depress the brake pedal around 10 times, with keeping the safe distance from other vehicles, lightly in order to dry the braking system. Such procedure may decrease the driving distance by restraining the regenerative braking system, which is not a system malfunction. Inspect the braking system after car wash or driving over wet road conditions.
-

NOTICE

- Do not continue depressing the brake pedal if the "READY" indicator is OFF. The battery may be discharged.
- Noise and vibration generated during braking is normal.
- Under normal operation, electric brake pump noise and motor vibration may occur temporarily in below cases.
 - When the pedal is depressed suddenly.
 - When the pedal is repeatedly depressed in short intervals.
 - When the ABS function is activated while braking.

Disc brakes wear indicator

When your brake pads are worn and new pads are required, you will hear a high pitched warning sound from your front or rear brakes. You may hear this sound come and go or it may occur whenever you depress the brake pedal.

NOTICE

To avoid costly brake repairs, do not continue to drive with worn brake pads.

***i* Information**

Always replace brake pads as complete front or rear axle sets.

⚠ WARNING

Frequent braking may deform components and worn the disc brake causing vibration when braking. Observe the speed limit to prevent brake damage from excessive braking.

Brake wear, noise, vibration from excessive braking or deformation of the brakes caused by repeatedly braking in high speed, racing on tracks, etc. can be excluded from warranty coverage.

Electronic Parking Brake (EPB)***Applying the parking brake*****To apply EPB (Electronic Parking Brake):**

1. Depress and hold the brake pedal.
2. Pull up the EPB switch.

Make sure the Parking Brake warning light comes on.

EPB (Electronic Parking Brake) may be automatically applied when:

- Requested by other systems
- The driver turns the vehicle off while Auto Hold is operating.

Emergency braking

If there is a problem with the brake pedal while driving, emergency braking is possible by pulling up and holding the EPB switch. Braking is possible only while you are holding the EPB switch. However, braking distance will be longer than normal.

WARNING

To reduce the risk of **SERIOUS INJURY** or **DEATH**, do not operate the EPB while the vehicle is moving except in an emergency situation. It could damage the brake system and lead to an accident.

Information

During emergency braking, the Parking Brake warning light will illuminate to indicate that the system is operating.

NOTICE

If you continuously notice a noise or burning smell when the EPB is used for emergency braking, we recommend that you have the system checked by an authorized HYUNDAI dealer.

Releasing the parking brake



To release EPB (Electronic Parking Brake):

1. Press the Start/Stop button to the ON or START position.
2. Press the EPB switch while depressing the brake pedal.

Make sure the Parking Brake warning light goes off.

To release EPB (Electronic Parking Brake) automatically:

- Gear in P (Park)
With the vehicle running depress the brake pedal and shift out of P (Park) to R (Reverse) or D (Drive).
- Gear in N (Neutral)
With the vehicle running depress the brake pedal and shift out of N (Neutral) to R (Reverse) or D (Drive).
- Satisfy the following conditions
 1. Ensure seat belts are fastened and the doors, hood and trunk are closed.
 2. With the vehicle running, depress the brake pedal and shift out of P (Park) to R (Reverse) or D (Drive).

3. Depress the accelerator pedal.

Make sure the Parking Brake warning light goes off.

i Information

- For the Middle East, EPB is released regardless of seat belt fastening.
- For your safety, you can engage EPB even though the Vehicle Stop/Start button is in the OFF position (only if battery power is available), but you cannot release it.
- For your safety, depress the brake pedal and release the parking brake manually with the EPB switch when you drive downhill or when backing up the vehicle.

NOTICE

- If the Parking Brake warning light is still on even though the EPB has been released, we recommend that you have the system checked by an authorized HYUNDAI dealer.
- Do not drive your vehicle with EPB applied. It may cause excessive brake pad and brake rotor wear.

Warning messages

To release EPB, fasten seatbelt and close door, hood and trunk

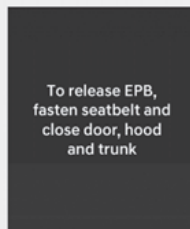

- If you try to drive with EPB applied, a warning will sound and a message will appear.
- If the driver's seat belt is unfastened and the hood or trunk is opened, a warning will sound and a message will appear.
- If there is a problem with the vehicle, a warning may sound and a message may appear.

If the situation occurs, depress the brake pedal and release EPB by pressing the EPB switch.

WARNING

- Whenever leaving the vehicle or parking, always come to a complete stop and continue to depress the brake pedal.
Shift the gear into P (Park), pull the EPB switch, and press the Start/Stop button to the OFF position. Take the Key with you when leaving the vehicle.
Vehicles not fully engaged in P (Park) with the parking brake set are at risk for moving inadvertently and causing injury to yourself or others.
- NEVER allow anyone who is unfamiliar with the vehicle to touch the EPB switch. If EPB is released unintentionally, serious injury may occur.
- Only release EPB when you are seated inside the vehicle with your foot firmly on the brake pedal.

CAUTION

In winter, the Electronic Parking Brake (EPB) related device may freeze and cannot be released. Do not use the Electronic Parking Brake (EPB) but park on a flat surface with the gear in P (Park). Use wheel chocks under the wheels if necessary. If the Electronic Parking Brake (EPB) applies automatically when the gear is shifted to P (Park), turn off Auto Hold, and press the Electronic Parking Brake (EPB) switch to release the parking brake.

NOTICE

- Do not apply the accelerator pedal while the parking brake is engaged. If you depress the accelerator pedal with EPB engaged, a warning will sound and a message will appear. Damage to the parking brake may occur.
- Driving with the parking brake on can overheat the braking system and cause premature wear or damage to brake parts. Make sure EPB is released and the Parking Brake warning light is off before driving.

i Information

- A clicking sound may be heard while operating or releasing the EPB. These conditions are normal and indicate that EPB is functioning properly.
- When leaving your keys with a parking attendant or assistant, make sure to inform him/her how to operate EPB.

AUTO HOLD turning Off! Press brake pedal

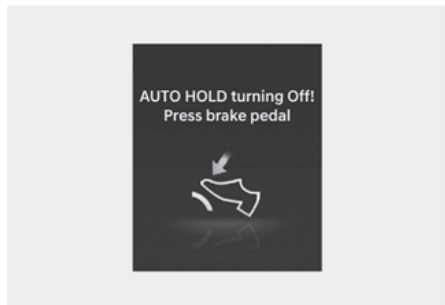

When the conversion from Auto Hold to EPB is not working properly a warning will sound and a message will appear.

Parking brake automatically engaged

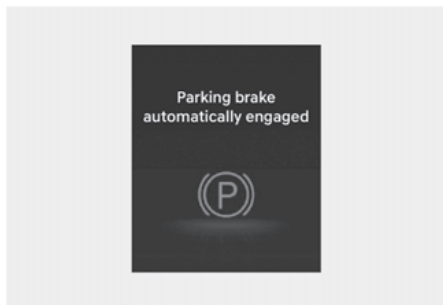

When EPB is applied while Auto Hold is activated, a warning will sound and a message will appear.

EPB malfunction

Electronic Parking Brake (EPB) warning light illuminates if the Start/Stop button is pressed to the ON position and goes off in about 3 seconds if the system is operating normally.

If the EPB warning light remains on, comes on while driving, or does not come on when the Start/Stop button is pressed to the ON position, this indicates that the EPB may have malfunctioned.

If this occurs, we recommend that you have the system checked by an authorized HYUNDAI dealer.

The EPB warning light may illuminate when the ESC indicator comes on to indicate that ESC is not working properly, but it does not indicate a malfunction of EPB.

NOTICE

- If the EPB warning light is still on, we recommend that you have the system checked by an authorized HYUNDAI dealer.
- If the Parking Brake warning light does not illuminate or blinks even though the EPB switch was pulled up, EPB may not be applied.
- If the Parking Brake warning light blinks when the EPB warning light is on, press the switch, and then pull it up. Repeat this one more time. If the EPB warning does not go off, we recommend that you have the system checked by an authorized HYUNDAI dealer.

Parking brake warning light



Check the Parking Brake warning light by pressing the Vehicle Stop/Start button to the ON position.

This light will be illuminated when the parking brake is applied with the vehicle Stop/Start button in the START or ON position.

Before driving, be sure the parking brake is released and the Parking brake warning light is OFF.

If the Parking brake warning light remains on after the parking brake is released while the motor is running, there may be a malfunction in the brake system. Immediate attention is necessary.

If at all possible, cease driving the vehicle immediately. If that is not possible, use extreme caution while operating the vehicle and only continue to drive the vehicle until you can reach a safe location.

When the EPB (Electronic Parking Brake) does not release

If the EPB does not release normally, we recommend that you contact an authorized HYUNDAI dealer by loading the vehicle on a flatbed tow truck and have the system checked.

Auto Hold

Auto Hold maintains the vehicle in a standstill even though the brake pedal is not depressed after the driver brings the vehicle to a complete stop by depressing the brake pedal.

To apply:

1. With the driver's door and hood closed, depress the brake pedal and then press the AUTO HOLD switch. The white AUTO HOLD indicator will come on and the system will be in the standby position.



2. When you stop the vehicle completely by depressing the brake pedal, Auto Hold maintains the brake pressure to hold the vehicle stationary. The indicator changes from white to green.



- (1) White
- (2) Green
3. The vehicle will remain stationary even if you release the brake pedal.
4. If EPB is applied, Auto Hold will be released.

To release:

If you depress the accelerator pedal with the gear in D (Drive) or Manual shift mode, the Auto Hold will be released automatically and the vehicle will start to move. The AUTO HOLD indicator changes from green to white.

⚠ WARNING

When Auto Hold is automatically released by depressing the accelerator pedal, always take a look around your vehicle. Slowly depress the accelerator pedal for a smooth start.

To cancel:

(1) OFF

1. Depress and hold the brake pedal.
2. Press the AUTO HOLD switch.

The AUTO HOLD indicator will turn off.

WARNING

To prevent, unexpected and sudden vehicle movement, ALWAYS press your foot on the brake pedal to cancel the Auto Hold before you:

- Drive downhill.
- Drive the vehicle in R (Reverse).
- Park the vehicle.

i **Information**

- The Auto Hold does not operate when:
 - The gear is in P (Park)
 - EPB is applied
- For your safety, the Auto Hold automatically switches to EPB when:
 - The driver's door is opened
 - The trunk is opened
 - The hood is opened
 - The vehicle is in a standstill for more than 10 minutes
 - The vehicle is standing on a steep slope
 - The vehicle moved several times

In these cases, the Parking brake warning light comes on, the AUTO HOLD indicator changes from green to white, and a warning sound and a message will appear to inform you that EPB has been automatically engaged. Before driving off again, depress the brake pedal, check the surrounding area near your vehicle and release the parking brake manually with the EPB switch.

- While operating Auto Hold, you may hear mechanical noise. However, it is normal operating noise.
- If the vehicle is restarted with the Auto Hold system in the standby position or operating, the Auto hold system will continue to operate in the standby position.

NOTICE

If the AUTO HOLD indicator changes to yellow, Auto Hold is not working properly. We recommend that you contact an authorized HYUNDAI dealer.

⚠ WARNING

- Depress the accelerator pedal slowly when you start the vehicle.
- For your safety, cancel Auto Hold when you drive downhill, back up the vehicle or park the vehicle.

NOTICE

If there is a malfunction with the driver's door or hood open detection system, Auto Hold may not work properly. We recommend that you contact an authorized HYUNDAI dealer.

Warning messages

Parking brake automatically engaged

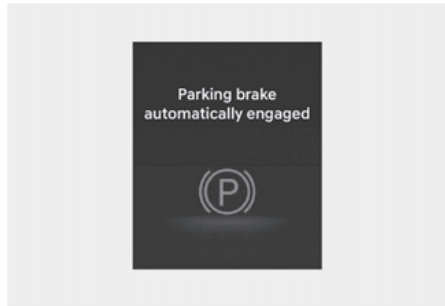

When EPB is applied while Auto Hold is activated, a warning will sound and a message will appear.

AUTO HOLD turning Off! Press brake pedal

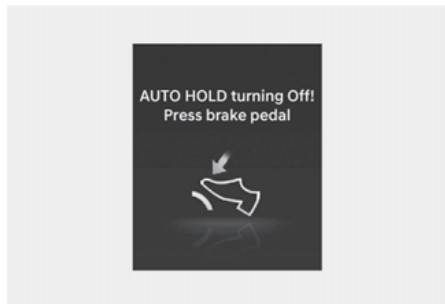

When the conversion from Auto Hold to EPB is not working properly a warning will sound and a message will appear.

When this message is displayed, Auto Hold and EPB may not operate. For your safety, depress the brake pedal.

Press brake pedal to deactivate AUTO HOLD

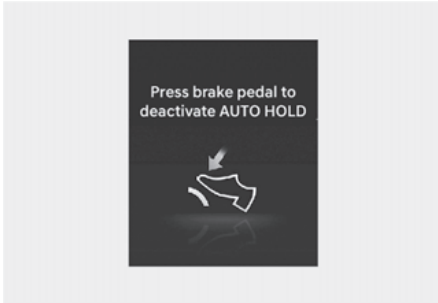

If you did not apply the brake pedal when you release Auto Hold by pressing the AUTO HOLD switch, a warning will sound and a message will appear.

Brake Disc Cleaning

Use the Brake Disc Cleaning function if noise is generated when depressing the brake while driving or if the brake disc gets rusty. It helps reduce the noise and rust. Regenerative braking is restrained while Brake Disc Cleaning is operated, which may lower the electric energy efficiency.

Press and hold the AUTO HOLD button for over 3 seconds.

- Brake Disc Cleaning starts operating when the message "**Brake disc cleaning**" is displayed on the instrument cluster.

- Regenerative braking is restrained while the brake is depressed about 10 times while driving (it may differ depending on driving conditions). It helps reduce the noise and rust.
- Brake Disc Cleaning function will turn off automatically when the operation is completed. It can also be turned off before operation is completed by turning off the vehicle or pressing the AUTO HOLD button for over 3 seconds.

Anti-lock Brake System (ABS)

WARNING

Anti-Lock Braking System (ABS) or Electronic Stability Control (ESC) system will not prevent accidents due to improper or dangerous driving maneuvers. Even though vehicle control is improved during emergency braking, always maintain a safe distance between you and objects ahead of you. Vehicle speeds should always be reduced during extreme road conditions. The braking distance for vehicles equipped with ABS or ESC may be longer than for those without these systems in the following road conditions.

Drive your vehicle at reduced speeds during the following conditions:

- Rough, gravel or snow-covered roads.
- On roads where the road surface is pitted or has different surface height.
- Tire chains are installed on your vehicle.

The safety features of ABS or ESC equipped vehicle should not be tested by high speed driving or cornering. This could endanger the safety of yourself or others.

ABS is an electronic braking system that helps prevent a braking skid. ABS allows the driver to steer and brake at the same time.

Using ABS

To obtain the maximum benefit from your ABS in an emergency situation, do not attempt to modulate your brake pressure and do not try to pump your brakes. Depress your brake pedal as hard as possible.

When you apply your brakes under conditions which may lock the wheels, you may hear sounds from the brakes, or feel a corresponding sensation in the brake pedal. This is normal and it means your ABS is active.

ABS does not reduce the time or distance it takes to stop the vehicle.

Always maintain a safe distance from the vehicle in front of you.

ABS will not prevent a skid that results from sudden changes in direction, such as trying to take a corner too fast or making a sudden lane change. Always drive at a safe speed for the road and weather conditions.

ABS cannot prevent a loss of stability. Always steer moderately when braking hard. Severe or sharp steering wheel movement can still cause your vehicle to veer into oncoming traffic or off the road.

On loose or uneven road surfaces, operation of the anti-lock brake system may result in a longer stopping distance than for vehicles equipped with a conventional brake system.

The ABS (ABS) warning light will stay on for several seconds after the Start/Stop button is in the ON position.

During that time, ABS will go through self-diagnosis and the light will go off if everything is normal. If the light stays on, you may have a problem with your ABS. We recommend that you contact an authorized HYUNDAI dealer as soon as possible.

WARNING

If the ABS (ABS) warning light is on and stays on, you may have a problem with the ABS. Your power brakes will work normally. To reduce the risk of serious injury or death, we recommend that you contact your authorized HYUNDAI dealer as soon as possible.

NOTICE

When you drive on a road having poor traction, such as an icy road, and apply your brakes continuously, ABS will be active continuously and the ABS (ABS) warning light may illuminate. Pull your vehicle over to a safe place and turn the vehicle off.

Restart the vehicle. If the ABS warning light is off, then your ABS system is normal.

Otherwise, you may have a problem with your ABS system. We recommend that you contact an authorized HYUNDAI dealer as soon as possible.

i Information

When you jump start your vehicle because of a drained battery, the ABS (ABS) warning light may turn on at the same time. This happens because of the low battery voltage. It does not mean your ABS is malfunctioning. Have the battery recharged before driving the vehicle.

Electronic Stability Control (ESC)

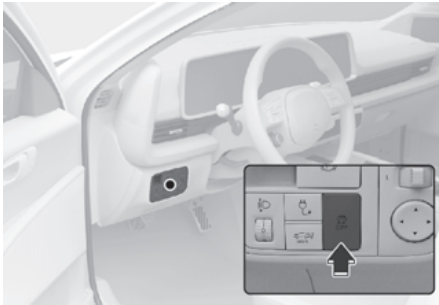

Electronic Stability Control helps to stabilize the vehicle during cornering maneuvers.

ESC checks where you are steering and where the vehicle is actually going. ESC applies braking pressure to any one of the vehicle's brakes and intervenes in the electric vehicle control system to assist the driver with keeping the vehicle on the intended path. It is not a substitute for safe driving practices. Always adjust your speed and driving to the road conditions.

WARNING

Never drive too fast for the road conditions when cornering. ESC will not prevent accidents.

Excessive speed in turns, abrupt maneuvers, and hydroplaning on wet surfaces can result in severe accidents.

ESC operation

ESC ON condition

When the Start/Stop button is in the ON position, ESC and the ESC OFF indicator lights illuminate for about three seconds. After both lights go off, ESC is enabled.

When operating



When ESC is in operation, the ESC indicator light blinks:

- When you apply your brakes under conditions which may lock the wheels, you may hear sounds from the brakes, or feel a corresponding sensation in the brake pedal. This is normal and it means your ESC is active.

- When ESC activates, the vehicle may not respond to the accelerator as it does under routine conditions.
- If Cruise Control was in use when ESC activates, Cruise Control automatically disengages. Cruise Control can be reengaged when the road conditions allow. See "Cruise Control (CC)" section in chapter 7 (if equipped).

ESC OFF condition



To cancel ESC operation:

- State 1

Press the ESC OFF button briefly. The ESC OFF indicator light and/or message "**Traction Control disabled**" will illuminate. In this state, the traction control function of ESC (electric vehicle control management) is disabled, but the brake control function of ESC (braking management) still operates.

- State 2

Press and hold the ESC OFF button continuously for more than 3 seconds. The ESC OFF indicator light and/or message "**Traction & Stability Control disabled**" illuminates and a warning chime sounds. In this state, both the traction control function of ESC (electric vehicle control management) and the brake control function of ESC (braking management) are disabled.

If the Start/Stop button is pressed to the OFF position when ESC is off, ESC remains off. Upon restarting the vehicle, ESC will automatically turn on again.

When ESC (electric vehicle control) is deactivated, the vehicle will lose the traction and stability if the vehicle is driven by abrupt steering wheel control. It is possible that the tire may make a collision with the connected parts of the tire. We recommend to do not turn off ESC while driving the vehicle for your safety.

Indicator lights

ESC indicator light (blinks)



ESC OFF indicator light (comes on)



When the Start/Stop button is pressed to the ON position, the ESC indicator light illuminates, then goes off if the ESC system is operating normally.

The ESC indicator light blinks whenever ESC is operating.

If the ESC indicator light stays on, your vehicle may have a malfunction with the ESC system. When this warning light illuminates we recommend that the vehicle be checked by an authorized HYUNDAI dealer as soon as possible.

The ESC OFF indicator light comes on when ESC is turned off.

WARNING

When ESC is blinking, this indicates ESC is active:

Drive slowly and NEVER attempt to accelerate. NEVER turn ESC off while the ESC indicator light is blinking or you may lose control of the vehicle resulting in an accident.

NOTICE

Driving with wheels and tires with different sizes may cause the ESC system to malfunction. Before replacing tires, make sure all four tires and wheels are the same size. Never drive the vehicle with different sized wheels and tires installed.

ESC OFF usage

When Driving

The ESC OFF mode should only be used briefly to help free the vehicle if stuck in snow or mud, by temporarily stopping operation of ESC, to maintain wheel torque.

To turn ESC off while driving, press the ESC OFF button while driving on a flat road surface.

NOTICE

To prevent damage to the reduction gear:

- Do not allow wheel(s) of one axle to spin excessively while the ESC, ABS, and Parking Brake warning lights are displayed. The repairs would not be covered by the vehicle warranty. Reduce motor power and do not spin the wheel(s) excessively while these lights are displayed.
 - When operating the vehicle on a dynamometer, make sure ESC is turned off (ESC OFF light illuminated).
-

i Information

- Turning ESC off does not affect ABS or standard brake system operation.
- Select 0 step of the regenerative braking system and depress the brake pedal around 10 times to efficiently apply brake disc cleaning.

Brake disc cleaning may decrease the driving distance by restraining the regenerative braking system. After brake disc cleaning, the regenerative braking system may be restored.

If the regenerative braking system is not restored after the brake disc cleaning, we recommend to inspect the vehicle by an authorized HYUNDAI dealer.

Vehicle Stability Management (VSM)

Vehicle Stability Management is a function of the Electronic Stability Control (ESC) system. It helps the vehicle stay stable when accelerating or braking suddenly on wet, slippery and rough roads where traction over the four tires can suddenly become uneven.

WARNING

Take the following precautions when using Vehicle Stability Management:

- ALWAYS check the speed and the distance to the vehicle ahead. VSM is not a substitute for safe driving practices.
 - Never drive too fast for the road conditions. VSM will not prevent accidents. Excessive speed in bad weather, on slippery and uneven roads can result in severe accidents.
-

VSM operation

When operating

When you apply your brakes under conditions which may activate ESC, you may hear sounds from the brakes, or feel a corresponding sensation in the brake pedal. This is normal and it means your VSM is active.

i Information

VSM does not operate when:

- Driving on a banked road such as gradient or incline.
- Driving in reverse.
- The ESC OFF indicator light is on.
- The MDPS (Motor Driven Power Steering) warning light (⚠) is on or blinks.

VSM OFF condition

To cancel VSM operation, press the ESC OFF button. ESC OFF (⚠) indicator light will illuminate.

To turn on VSM, press the ESC OFF button again. The ESC OFF indicator light will go out.

WARNING

If the ESC (⚠) indicator light or MDPS (⚠) warning light stays illuminated or blinks, your vehicle may have a malfunction with the VSM system. When the warning light illuminates we recommend that the vehicle be checked by an authorized HYUNDAI dealer as soon as possible.

NOTICE

Driving with wheels and tires with different sizes may cause the VSM system to malfunction. Before replacing tires, make sure all four tires and wheels are the same size. Never drive the vehicle with different sized tires and wheels installed.

Hill-Start Assist Control (HAC)

Hill-Start Assist Control helps prevent the vehicle from rolling backwards when starting a vehicle from a stop on a hill. The system operates the brakes automatically for about 2 seconds (maximum of 5 seconds when the accelerator pedal is slightly depressed during HAC operation) and releases the brake after 2 seconds or when the accelerator pedal is depressed.

WARNING

Always be ready to depress the accelerator pedal when starting off an incline. Hill-Start Assist Control activates only for about 2 seconds (maximum of 5 seconds when the accelerator pedal is slightly depressed during HAC operation).

i Information

- Hill-Start Assist Control does not operate when the gear is shifted to P (Park) or N (Neutral).
- Hill-Start Assist Control activates even when the ESC (Electronic Stability Control) is off. However, it does not activate, when ESC does not operate normally.

Emergency Stop Signal (ESS)

Emergency Stop Signal alerts the driver behind by blinking the stop lights, while sharply and severely braking.

The system is activated when:

- The vehicle suddenly stops. (The deceleration power exceeds 7 m/s, and the driving speed exceeds 55 km/h (34 mph).)
- ABS is activated and the driving speed exceeds 55 km/h (34 mph).

The hazard warning flasher automatically turns ON after blinking the stop lights:

- When driving speed is under 40 km/h (25 mph),
- When ABS is deactivated, and
- When the sudden braking situation is over.

The hazard warning flasher turns OFF:

- When the vehicle drives at a low speed for a certain period of time.

The driver can manually turn OFF the hazard warning flasher by pressing the button.

i Information

Emergency Stop Signal will not activate, when the hazard warning flashers are already on.

Multi-Collision Brake (MCB)

Multi-Collision Brake controls the brake automatically in the event of an accident where the airbag deploys to reduce the risk of additional accidents that may occur.

System operation

- From the time the airbag deploys, Multi-Collision Brake monitors the depression intensity of the brake pedal and accelerator pedal for a short period. The system operates when the following conditions are met:
 - Vehicle speed is under 180 km/h (112 mph) at the time of collision.
 - The brake pedal and accelerator pedal is hardly depressed.
- When the driver steps on the brake pedal over a certain level while Multi-Collision Brake is active, the braking power takes priority over automatic braking by Multi-Collision Brake system. However, if the driver takes his/her foot off the brake pedal, automatic braking by Multi-Collision Brake system will maintain automatic braking.

System off

Multi-Collision Brake is canceled in the following situations:

- The accelerator pedal is depressed over a certain level.
- The vehicle stops.
- ESC (Electronic Stability Control) or electronic devices has malfunctioned.
- In a situation system cannot operate normally.
- Ten seconds have passed since the brake has been controlled automatically by Multi-Collision Brake system.

WARNING

- Multi-Collision Brake decreases vehicle speed after a collision, but it does not prevent a second collision. You may drive away from the collision spot to avoid other dangerous situations by depressing the accelerator pedal.
 - After the vehicle is stopped by Multi-Collision Brake, the system stops controlling the brakes. Depending on the situation, the driver should depress the brake or the accelerator pedal to prevent further accidents.
-

Brake Assistant System (BAS)

The Brake Assistant System provides additional pressure when the brake pedal is momentarily and strongly depressed in a situation sudden braking is required while driving.

The Brake Assistant System reduces the time for ABS(Anti-Lock Brake System) control to enter and consequently reduces the braking distance, by providing additional pressure up to the point of ABS intervention.

WARNING

The system may not operate depending on driver's driving habit, driving speed, the degree to which the brake pedal is depressed and the road surface condition.

Good braking practices

WARNING

Whenever leaving the vehicle or parking, always come to a complete stop and continue to depress the brake pedal. Shift the gear to the P (Park) position, then apply the parking brake, and press the Start/Stop button to the OFF position.

Vehicles parked with the parking brake not applied or not fully engaged may roll inadvertently and may cause injury to the driver and others. ALWAYS apply the parking brake before exiting the vehicle.

Be aware of wet brakes. The brakes may get wet if the vehicle is driven through standing water or if it is washed. Your vehicle will not stop as quickly if the brakes are wet. Wet brakes may cause the vehicle to pull to one side.

To dry the brakes, apply the brakes lightly until the braking action returns to normal. If the braking action does not return to normal, stop as soon as it is safe to do so and we recommend that you call an authorized HYUNDAI dealer for assistance.

DO NOT drive with your foot resting on the brake pedal. Even light, but constant pedal pressure can result in the brakes overheating, brake wear, and possibly even brake failure.

If a tire goes flat while you are driving, apply the brakes gently and keep the vehicle pointed straight ahead while you slow down. When you are moving slowly enough for it to be safe to do so, pull off the road and stop in a safe location.

Keep your foot firmly on the brake pedal when the vehicle is stopped to prevent the vehicle from rolling forward.

All Wheel Drive (AWD)

 if equipped

When All Wheel Drive (AWD) is activated, driving forces are distributed appropriately to front and rear wheels. It could improve driving performance by maximizing the driving force of vehicles on severe road conditions such as steep hills, unpaved, slippery, etc.

Advantage of electronic AWD

1. Improvement of straight stability
2. Improvement of driving performance on curve
3. Secure stability on severe condition such as wet and sandy roads.
4. Improvement of energy efficiency from driving mode automatic control.

Information

AWD vehicles could change the engagement status of the motor according to the situation required. Auto changing the driving mode(2WD/AWD) helps improve energy efficiency and driving stability.

⚠ WARNING

To reduce the risk of SERIOUS INJURY or DEATH:

- Avoid high speeds when cornering or turning.
- Do not make quick steering wheel movements, such as sharp lane changes or fast, sharp turns.
- The risk of a rollover is greatly increased if you lose control of your vehicle at highway speeds.
- Loss of control often occurs if two or more wheels drop off the roadway and the driver over steers to reenter the roadway.
- In the event your vehicle leaves the roadway, do not steer sharply. Instead, slow down before pulling back into the travel lanes.

NOTICE

- Do not drive in water if the level is higher than the bottom of the vehicle.
- Check your brake condition once you are out of mud or water. Depress the brake pedal several times as you move slowly until you feel normal braking return.
- Shorten your scheduled maintenance interval if you drive in off-road conditions such as sand, mud or water (see "Maintenance under severe usage conditions" section in chapter 9).
- Always wash your vehicle thoroughly after off road use, especially the bottom of the vehicle.
- Be sure to equip the vehicle with four tires of the same size and type.
- Make sure that a full time AWD vehicle is towed by a flat bed tow truck.

For safe AWD operation**Before driving**

- Make sure all passengers are wearing seat belts.
- Sit upright and closer to the steering wheel than usual. Adjust the steering wheel to a position comfortable for you to drive.

Driving on snow-covered or icy roads

- Start off slowly by applying the accelerator pedal gently.
- Use snow tires or tire chains.
- Keep sufficient distance between your vehicle and the vehicle in front of you.
- Using regenerative braking helps the steering on the downhill. However, it may be difficult to adjust the vehicle while coasting using regenerative braking, so avoid using the third level of regenerative braking as much as possible.
- Avoid speeding, rapid acceleration, sudden brake applications, and sharp turns to prevent skids.
- It is difficult to start again if the vehicle stops on an uphill road. Keep your distance from other vehicles and drive slowly.

i Information

When using Snow Tires, mount them on all four wheels.

When using tire chains, install them on the rear tires.

However, driving speed must be below 30 km/h and minimize the driving distance. High-speed or long-term driving with tire chains installed may malfunction or damage the AWD system.

For more information on Snow Tires and Tire Chains, refer to the "Winter driving" section in this chapter.

Driving in sand or mud

- Maintain slow and constant speed.
- Use tire chains driving in mud if necessary.
- Keep sufficient distance between your vehicle and the vehicle in front of you.
- Reduce vehicle speed and always check the road condition.
- Avoid speeding, rapid acceleration, sudden brake applications, and sharp turns to prevent getting stuck.

NOTICE

When the vehicle is stuck in snow, sand or mud, place a nonslip material under the drive wheels to provide traction OR slowly spin the wheels in forward and reverse directions which causes a rocking motion that may free the vehicle.

Driving up or down hills

- Driving uphill
 - Before starting off, check if it is possible to drive uphill.
 - Drive as straight as possible.
- Driving downhill
 - Do not change gear while driving downhill. Select gear before driving downhill.
 - Drive straight as possible.

WARNING

Exercise extreme caution driving up or down steep hills. The vehicle may flip over depending on the grade, terrain, water and mud conditions.

WARNING

Do not drive across the contour of steep hills. A slight change in the wheel angle can destabilize the vehicle, or a stable vehicle may lose stability if the vehicle stops its forward motion. Your vehicle may roll over and lead to a serious injury or death.

Additional driving conditions

- Become familiar with the off-road conditions before driving.
- Always pay attention when driving off-road and avoid dangerous areas.
- Drive slowly when driving in heavy wind.

- Reduce vehicle speed when cornering. The center of gravity of AWD vehicles is higher than conventional 2WD vehicles, making them more likely to roll over when you rapidly turn corners.
- Always hold the steering wheel firmly when you are driving off-road.

WARNING

Do not grab the inside of the steering wheel when you are driving off-road. You may hurt your arm by a sudden steering maneuver or from steering wheel rebound due to an impact with objects on the ground. You could lose control of the steering wheel which may lead to serious injury or death.

Emergency precautions

Tires

When replacing tires, be sure to equip all four tires with the same size, type, tread patterns, brand and load-carrying capacity.

WARNING

Do not use tire and wheel with different size and type from the one originally installed on your vehicle. It can affect the safety and performance of your vehicle, which could lead to steering failure or rollover causing serious injury.

WARNING

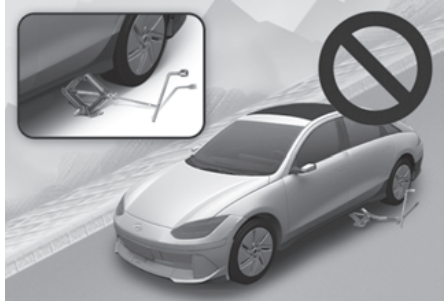

Never start or run the vehicle while an AWD vehicle is raised on a jack. The vehicle can slip or roll off of a jack causing serious injury or death to you or those nearby.

Towing

AWD vehicles must be towed with a wheel lift and dollies or flatbed equipment with all the wheels off the ground. For more information, refer to the "Towing" section in chapter 8.

Vehicle inspection

- If the vehicle needs to be operated on a vehicle lift do not attempt to stop any of the four wheels from turning. This could damage the AWD system.
- Never engage the parking brake while running the vehicle on a car lift. This may damage the AWD system.

Dynamometer testing

An AWD vehicle must be tested on a special four wheel chassis dynamometer.

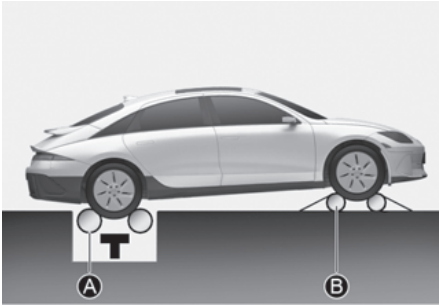

[A] Roll tester (Speedometer),
[B] Temporary free roller

An AWD vehicle should not be tested on a 2WD roll tester. If a 2WD roll tester must be used, perform the following procedure:

1. Check the tire pressures recommended for your vehicle.
2. Place the rear wheels on the roll tester for a speedometer test as shown in the illustration.
3. Release the parking brake.
4. Place the front wheels on the temporary free roller as shown in the illustration.

WARNING

Keep away from the front of the vehicle while the vehicle is in gear on the dynamometer. The vehicle can jump forward and cause serious injury or death.

Drive mode integrated control system (2WD)

 If equipped

Drive mode



Drive mode may be selected according to the driver's preference or road condition.



The mode changes whenever the driver pushes the DRIVE MODE button.

NORMAL mode

Normal mode is a driving mode used when driving on general roads, city center and highways.

ECO mode

ECO mode is a driving mode improving energy efficiency by controlling motors and reduction gear.

Electric energy efficiency varies according to the driver's driving habit and road condition.

- When ECO mode is selected, the ECO indicator will illuminate on the instrument cluster and the color of the mood lamp will change.
- When ECO mode is activated:
 - The acceleration response may be slightly reduced if the accelerator pedal is depressed moderately.
 - The air conditioner performance may be limited.

The above situations are normal conditions when ECO mode is activated to help improve electric energy efficiency.

Limitations of ECO mode

If the following conditions occur while ECO mode is operating, the system operation is limited even though there is no change in the ECO indicator.

- When coolant temperature is low:

The system will be limited until motor performance becomes normal.
- When driving up a hill:

The system will be limited to gain power when driving uphill because motor torque is restricted.

SPORT mode

SPORT mode is a driving mode improving driving performance by controlling motors and reduction gear.

In SPORT mode, the electric energy efficiency may decrease.

- When SPORT mode is selected, the SPORT indicator will illuminate on the instrument cluster and the color of the mood lamp will change.
- Whenever the vehicle is restarted, the drive mode will revert back to NORMAL mode. If SPORT mode is desired, re-select SPORT mode.

SNOW mode

SNOW mode provides safe driving on the snowy roads.

- Press and hold the drive mode button to select SNOW mode.
- When SNOW mode is selected, the SNOW indicator will illuminate on the instrument cluster and the color of the mood lamp will change.

NOTICE

- Depress the accelerator pedal softly on the snow and the ice.
- Keep the distance from the vehicle in the front.
- Prevent rapid acceleration, deceleration and steering control. Abrupt driving on the snow may cause the accident.

MY DRIVE MODE

In MY DRIVE MODE, you can adjust the vehicle performance for each function. To set **MY DRIVE MODE**, go to **Setup (Settings) > Vehicle > Drive mode > CUSTOM > MY DRIVE MODE** in the infotainment system.

	MY DRIVE MODE
Power output	Maximized/Normal/Minimized
Acceleration sensitivity	High/Moderate/Low
Steering	NORMAL/SPORT

Press and hold the drive mode button to select MY DRIVE MODE. The MY DRIVE MODE indicator will illuminate on the instrument cluster.

- If the controller is replaced or the controller software is updated, the setting of MY DRIVE MODE may be initialized.

Drive mode integrated control system (AWD)

 if equipped

Drive mode



Drive mode may be selected according to the driver's preference or road condition.

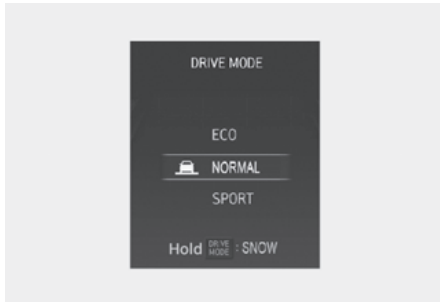

The mode changes whenever the driver pushes the DRIVE mode button.

NORMAL mode

Normal mode is a driving with auto changing the driving mode(2WD/AWD) on road condition.

ECO mode

ECO mode is a driving mode vehicles could change the engagement status of the motor according to the situation required. Auto changing the driving mode(2WD/AWD) helps improve energy efficiency.

Electric energy efficiency varies according to the driver's driving habit and road condition.

- When ECO mode is selected, the ECO indicator will illuminate on the instrument cluster and the color of the mood lamp will change.
- When ECO mode is activated:
 - The acceleration response may be slightly reduced if the accelerator pedal is depressed moderately.
 - The air conditioner performance may be limited.
 - The shift pattern of the reduction gear may change.

The above situations are normal conditions when ECO mode is activated to help improve electric energy efficiency.

Limitations of ECO mode

If the following conditions occur while ECO mode is operating, the system operation is limited even though there is no change in the ECO indicator.

- When coolant temperature is low:

The system will be limited until motor performance becomes normal.

- When driving up a hill:

The system will be limited to gain power when driving uphill because motor torque is restricted.

SPORT mode

SPORT mode is a driving mode improving driving performance by fixing AWD system and controlling reduction gear.

In SPORT mode, the electric energy efficiency may decrease.

- When SPORT mode is selected, the SPORT indicator will illuminate on the instrument cluster and the color of the mood lamp will change.
- Whenever the vehicle is restarted, the drive mode will revert back to NORMAL mode. If SPORT mode is desired, re-select SPORT mode.

SNOW mode

SNOW mode is a driving mode improving driving performance by changing the engagement status of the motor according to the situation required. Auto changing the driving mode(2WD/4WD)helps improve driving stability.

- Press and hold the drive mode button to select SNOW mode.
- When SNOW mode is selected, the SNOW indicator will illuminate on the instrument cluster and the color of the mood lamp will change.
- When SNOW mode is activated, the driving power is distributed to four wheels automatically, increasing the stability of the vehicle.

NOTICE

- Depress the accelerator pedal softly on the snow and the ice.
 - Keep the distance from the vehicle in the front.
 - Prevent rapid acceleration, deceleration and steering control. Abrupt driving on the snow may cause the accident.
-

MY DRIVE MODE

In MY DRIVE MODE, you can adjust the vehicle performance for each function. To set **MY DRIVE MODE**, go to **Setup (Settings) > Vehicle > Drive mode > CUSTOM > MY DRIVE MODE** in the infotainment system.

	MY DRIVE MODE
Power output	Maximized/Normal/Minimized
Acceleration sensitivity	High/Moderate/Low
Steering	NORMAL/SPORT
Driveline	AWD/AUTO AWD/2WD

Press and hold the drive mode button to select MY DRIVE MODE. The MY DRIVE MODE indicator will illuminate on the instrument cluster.

- When driving in 2WD, AWD will operate under following conditions:
 - Driving at low speed or stopping
 - Driving on an uphill or slippery road
 - Malfunction of the rear-wheel motor
- If the controller is replaced or the controller software is updated, the setting of MY DRIVE MODE may be initialized.

Drive modes characteristic

The characteristic of each components varies according to which drive mode is selected.

Drive mode	SNOW	NORMAL	ECO	SPORT
Characteristics	Snow driving	Normal driving mode	High electric energy efficiency mode	Sporty driving mode
Button activation	Press more than 1 sec.	Press	Press	Press
Indicator on the instrument cluster	SNOW	NORMAL	ECO	SPORT
Climate system control	NORMAL	NORMAL	ECO (ECO/NORMAL) *1	NORMAL
Speed Limit	-	-	-	-
Regenerative braking level	0-1	0-3		
BRAKE MODE	NORMAL/SPORT *1	NORMAL/SPORT *1	NORMAL/SPORT *1	NORMAL/SPORT *1

*1 It is possible to set the driving condition for each drive mode, at the drive mode setting in Infotainment system, For more information, refer to the separately supplied manual.

Active air flap



Active air flap system controls the air flap below the front bumper to cool the vehicle parts and improve energy efficiency.

i Information

Active air flap system could be activate regardless of the vehicle condition.(Parking, driving, charging, etc.)

Malfunction

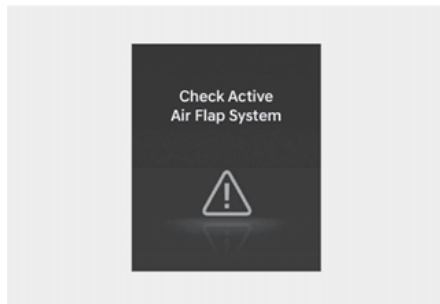

The active air flap system may not operate normally if the air flap is temporarily opened due to foreign factors or if the controller is contaminated by snow or rain, etc.

When "**Check the active air flap system**" is popped up on display, stop the vehicle in a safe place and check the status of the air flap.

Start the vehicle after performing the necessary work like foreign matter removal and waiting 10 minutes. If the pop-up remains up we recommend to contact an authorized HYUNDAI dealer.

CAUTION

- Regardless of the pop-up, if the air flaps aren't in the same position, stop the vehicle and wait for 10 minutes and start the vehicle and inspect the air flap.
- The active air flap system is actuated by motors. Do not disturb actuation or apply force excessively. It may cause failure.

Active sound design

 if equipped

- Active Sound Design provides various virtual driving sounds based on the driving mode, vehicle speed, and accelerator pedal. You can adjust the volume and change the settings for acceleration pedal response and sound style.
- To change the volume of the Active Sound Design in the infotainment system, select: **Setup > Vehicle > Active Sound Design**, or **Setup > Sound > Active Sound Design**.
- The volume of the Active Sound Design is adjusted according to the drive mode (Eco, Normal, Sport) selected.
- Any unauthorized replacement of the vehicle's speaker and amplifier may cause Active Sound Design to malfunction.

Information

The infotainment system may change after software updates. For more information, refer to the manual provided in the infotainment system and the quick reference guide.

Special driving conditions

Hazardous driving conditions

When hazardous driving elements are encountered such as water, snow, ice, mud and sand, take the following precautions:

- Drive cautiously and maintain a longer braking distance.
- Avoid abrupt braking or steering.
- When your vehicle is stuck in snow, mud, or sand, accelerate slowly to avoid unnecessary wheel spin.
- Put sand, rock salt, tire chains or other non-slip materials under the wheels to provide additional traction while the vehicle becomes stuck in ice, snow, or mud.

WARNING

Changing the tire speed suddenly could cause the tires to skid while driving on slippery surface. Be careful when driving on slippery surfaces.

Rocking the vehicle

If it is necessary to rock the vehicle to free it from snow, sand, or mud, first turn the steering wheel right and left to clear the area around your front wheels. Then, shift back and forth between R (Reverse) and a forward gear.

Try to avoid spinning the wheels, and do not race the vehicle.

To prevent reduction gear wear, wait until the wheels stop spinning before shifting gears. Release the accelerator pedal while shifting, and press lightly on the accelerator pedal while the reduction gear is in gear. Slowly spinning the wheels in forward and reverse directions causes a rocking motion that may free the vehicle.

WARNING

If the vehicle is stuck and excessive wheel spin occurs, the temperature in the tires can increase very quickly. If the tires become damaged, a tire blow out or tire explosion can occur. This condition is dangerous - you and others may be injured. Do not attempt this procedure if people or objects are anywhere near the vehicle.

If you attempt to free the vehicle, the vehicle can overheat quickly, possibly causing an motor compartment fire or other damage. Try to avoid spinning the wheels as much as possible to prevent overheating of either the tires or the motor. DO NOT allow the vehicle to spin the wheels above 56 km/h (35 mph).

i Information

The ESC system must be turned OFF before rocking the vehicle.

NOTICE

If you are still stuck after rocking the vehicle a few times, have the vehicle pulled out by a tow vehicle to avoid motor overheating, possible damage to the reduction gear, and tire damage. See "Towing" section in chapter 8.

Smooth cornering

Avoid braking or gear changing in corners, especially when roads are wet. Ideally, corners should always be taken under gentle acceleration.

Driving at night

Night driving presents more hazards than driving in the daylight. Here are some important tips to remember:

- Slow down and keep more distance between you and other vehicles, as it may be more difficult to see at night, especially in areas where there may not be any street lights.
- Adjust your mirrors to reduce the glare from other drivers' headlights.
- Keep your headlights clean and properly aimed. Dirty or improperly aimed headlights will make it much more difficult to see at night.
- Avoid staring directly at the headlights of oncoming vehicles. You could be temporarily blinded, and it will take several seconds for your eyes to readjust to the darkness.

Driving in the rain

Rain and wet roads can make driving dangerous. Here are a few things to consider when driving in the rain or on slick pavement:

- Slow down and allow extra following distance. A heavy rainfall makes it harder to see and increases the distance needed to stop your vehicle.
- Turn OFF your Cruise Control. (if equipped)
- Replace your windshield wiper blades when they show signs of streaking or missing areas on the windshield.
- Be sure your tires have enough tread. If your tires do not have enough tread, making a quick stop on wet pavement can cause a skid and possibly lead to an accident.

For more information, refer to the "Tire replacement" section in chapter 9.

- Turn on your headlights to make it easier for others to see you.
- Driving too fast through large puddles can affect your brakes. If you must go through puddles, try to drive through them slowly.
- If you believe your brakes may be wet, apply them lightly while driving until normal braking operation returns.

Hydroplaning

If the road is wet enough and you are going fast enough, your vehicle may have little or no contact with the road surface and actually ride on the water. The best advice is SLOW DOWN when the road is wet.

The risk of hydroplaning increases as the depth of tire tread decreases, refer to the "Tire replacement" section in chapter 9.

Driving in flooded areas

Avoid driving through flooded areas unless you are sure the water is no higher than the bottom of the wheel hub. Drive through any water slowly. Allow adequate stopping distance because brake performance may be reduced.

After driving through water, dry the brakes by gently applying them several times while the vehicle is moving slowly.

Highway driving

Tires

Adjust the tire inflation, as specified. Under-inflation may overheat or damage the tires.

Do not install worn-out or damaged tires, which may reduce traction or fail the braking operation.

i Information

Never over-inflate your tires above the maximum inflation pressure, as specified on your tires.

Coolant and high voltage battery

Driving at higher speeds on the highway consumes more electric energy and is less efficient than driving at a slower, more moderate speed. Maintain a moderate speed in order to conserve electric energy when driving on the highway.

Be sure to check both the coolant level and the electric energy level before driving.

Winter driving

The severe weather conditions of winter quickly wear out tires and cause other problems. To minimize winter driving problems, you should take the following suggestions:

Snow or icy conditions

You need to keep sufficient distance between your vehicle and the vehicle in front of you.

Apply the brakes gently. Speeding, rapid acceleration, sudden brake applications, and sharp turns are potentially very hazardous practices. Sudden brake applications on snowy or icy roads may cause the vehicle to skid.

To drive your vehicle in deep snow, it may be necessary to install tire chains on your tires.

Always carry emergency equipment. Some of the items you may want to carry include tire chains, tow straps or chains, a flashlight, emergency flares, sand, a shovel, jumper cables, a window scraper, gloves, ground cloth, coveralls, a blanket, etc.

Snow tires

WARNING

Snow tires should be equivalent in size and type to the vehicle's standard tires. Otherwise, the safety and handling of your vehicle may be adversely affected.

If you mount snow tires on your vehicle, make sure to use radial tires of the same size and load range as the original tires. Mount snow tires on all four wheels to balance your vehicle's handling in all weather conditions. The traction provided by snow tires on dry roads may not be as high as your vehicle's original equipment tires. Check with the tire dealer for maximum speed recommendations.

Information

Do not install studded tires without first checking local and municipal regulations for possible restrictions against their use.

Summer tires

 If equipped

- Summer tires are used to maximize the driving performance on dry roads.
- If the temperature is below 7 °C or you are driving on snowy or icy roads, the summer tires lose their brake performance and traction as the tire grip weakens significantly.
- If the temperature is below 7 °C or you are driving on snowy or icy roads, mount snow tires or all-season tires of the same size with your vehicle's standard tire for safe driving. Both snow and all-season tires have M+S markings.
- When using the M+S tires, use tires with the same tread produced by the same manufacturer for safe driving.
- When driving with the M+S tires with the lower maximum allowable speed than that of the vehicle's standard summer tire, be careful not to exceed the speed allowed for the M+S tires.

Tire chains (Wire chains)



Since the sidewalls of radial tires are thinner than other types of tires, they may be damaged by mounting some types of tire chains on them. Therefore, the use of snow tires is recommended instead of tire chains. If tire chains must be used, use genuine HYUNDAI parts and install the tire chain after reviewing the instructions provided with the tire chains. Damage to your vehicle caused by improper tire chain use is not covered by your vehicle manufacturer's warranty.

When using tire chains, install tire chains only on the rear tires.

WARNING

The use of tire chains may adversely affect vehicle handling:

- Drive less than 30 km/h (20 mph) or the chain manufacturer's recommended speed limit, whichever is lower.
- Drive carefully and avoid bumps, holes, sharp turns, and other road hazards, which may cause the vehicle to bounce.
- Avoid sharp turns or locked wheel braking.

i **Information**

- Install tire chains only in pairs and on the rear tires. It should be noted that installing tire chains on the tires will provide a greater driving force, but will not prevent side skids.
- Do not install studded tires without first checking local and municipal regulations for possible restrictions against their use.

Tire chains (Auto sock)



Since the sidewalls of radial tires are thinner, they can be damaged by mounting some types of snow chains on them. Therefore, the use of snow tires is recommended instead of snow chains.

Do not mount tire chains on vehicle equipped with aluminum wheels; snow chains may cause damage to the wheels. If snow chains must be used, use AutoSock (fabric snow chain). Damage to your vehicle caused by improper snow chain use is not covered by your vehicle manufacturer's warranty.

When using tire chains, install tire chains only on the rear tires.

 **CAUTION**

Always check chain installation for proper mounting after driving about 0.5-1 km (0.3-0.6 mi.) to ensure safe mounting. Retighten or remount the chains if they are loose.

Chain Installation

When installing tire chains, follow the manufacturer's instructions and mount them as tightly possible. Drive slowly (less than 30 km/h (20 mph)) with chains installed. If you hear the chains contacting the body or chassis, stop and tighten them. If they still make contact, slow down until the noise stops. Remove the tire chains as soon as you begin driving on cleared roads.

When mounting snow chains, park the vehicle on level ground away from traffic. Turn on the vehicle Hazard Warning Flasher and place a triangular emergency warning device behind the vehicle (if available). Always place the vehicle in P (Park), apply the parking brake and turn off the vehicle before installing snow chains.

NOTICE

When using tire chains:

- Wrong size chains or improperly installed chains can damage your vehicle's brake lines, suspension, body and wheels.
 - Use SAE "S" class or wire chains.
 - If you hear noise caused by chains contacting the body, retighten the chain to prevent contact with the vehicle body.
 - To prevent body damage, retighten the chains after driving 0.5-1.0 km (0.3-0.6 mi.).
 - Do not use tire chains on vehicles equipped with aluminum wheels. If unavoidable, use a wire type chain.
 - Install tire chains that meet the specifications of each tire size to prevent damage your vehicle.
 - 18 in. tires use wire chains less than 15 mm (0.59 in.).
 - 20 in. tires use AutoSock (fabric snow chain).
-

Winter precautions

Check battery and cables

Winter temperatures affect battery performance. Inspect the battery and cables, as specified in chapter 9. The battery charging level can be checked by an authorized HYUNDAI dealer or in a service station.

To prevent locks from freezing

To prevent the locks from being frozen, spray approved de-icing fluid or glycerin into key holes. When a lock opening is already covered with ice, spray approved de-icing fluid over the ice to remove it. When an internal part of a lock freezes, try to thaw it with a heated key. Carefully use the heated key to avoid an injury.

Use approved window washer anti-freeze solution in system

To prevent the window washer from being frozen, add authorized window washer anti-freeze solution, as specified on the window washer container. Window washer anti-freeze solution is available from an authorized HYUNDAI dealer, and most vehicle accessory outlets. Do not use coolant or other types of anti-freeze solution, to prevent any damage to the vehicle paint.

Do not let your parking brake freeze

Under some conditions your parking brake can freeze in the engaged position. This is most likely to happen when there is an accumulation of snow or ice around or near the rear brakes or if the brakes are wet. When there is the risk that your parking brake may freeze, temporarily apply it with the gear in P (Park). Also, block the rear wheels in advance, so the vehicle may not roll. Then, release the parking brake.

Do not let ice and snow accumulate underneath

Under some conditions, snow and ice can build up under the fenders and interfere with the steering. When driving in such conditions during the severe winter, you should check underneath the vehicle on a regular basis, to ensure that the front wheels and the steering components is unblocked.

Carry emergency equipment

In accordance with weather conditions, you should carry appropriate emergency equipment, while driving. Some of the items you may want to carry include tire chains, tow straps or chains, flashlight, emergency flares, sand, shovel, jumper cables, window scraper, gloves, ground cloth, coveralls, blanket, etc.

Do not place objects or materials in the motor compartment

Putting objects or materials in the motor compartment may cause an motor failure. Such damage will not be covered by the manufacturer's warranty.

Trailer towing

If you are considering to tow with your vehicle, you should first your country's legal requirements. As laws vary the requirements for towing trailers, cars, or other types of vehicles or apparatus may differ. We recommend to contact an authorized HYUNDAI dealer for further details before towing. Remember that trailering is different than just driving your vehicle by itself. Trailering means changes in handling, durability, and electric energy economy. Successful, safe trailering requires correct equipment, and it has to be used properly. Damage to your vehicle caused by improper trailer towing is not covered by your vehicle manufacturer's warranty. This section contains many time-tested, important trailering tips and safety rules. Many of these are important for your safety and that of your passengers. Please read this section carefully before you pull a trailer.

WARNING

Take the following precautions:

- If you don't use the correct equipment and/or drive improperly, you can lose control of the vehicle when you are pulling a trailer. For example, if the trailer is too heavy, the braking performance may be reduced. You and your passengers could be seriously or fatally injured. Pull a trailer only if you have followed all the steps in this section.
- Before towing, make sure the total trailer weight, GCW (Gross Combination Weight), GVW (Gross Vehicle Weight), GAW (Gross Axle Weight) and trailer tongue load are all within the limits.

i Information

- Do not install any equipment on the vehicle that blocks the license plate and cannot be easily removed or repositioned.
- When a trailer is not used, detach it from the vehicle so that the license plate is visible.

i Information

For Europe

- The technically permissible maximum load on the rear axle(s) may be exceeded by not more than 15 % and the technically permissible maximum laden mass of the vehicle may be exceeded by not more than 10 % or 100 kg (220.4 lbs), whichever value is lower. In this case, do not exceed 100 km/h (62.1 mph) for vehicle of category M1 or 80 km/h (49.7 mph) for vehicle of category N1.
 - When a vehicle of category M1 is towing a trailer, the additional load imposed at the trailer coupling device may cause the tire maximum load ratings to be exceeded, but not by more than 15 %. In this case, do not exceed 100 km/h (62.1 mph) and increase the tire inflation pressure by at least 0.2 bar.
- * M1: passenger vehicle (9-seater or under)
* N1: commercial vehicle (3.5 ton or under)

CAUTION

- Always have your eyes on the road when towing a trailer. When a trailer is connected to the tow hitch harness installed to your vehicle, the following functions are turned off automatically:
 - Forward Collision-Avoidance Assist
 - Lane Keeping Assist
 - Blind-Spot Collision-Avoidance Assist
 - Safe Exit Warning
 - Cruise Control
 - Smart Cruise Control
 - Navigation-based Smart Cruise Control
 - Lane Following Assist
 - Highway Driving Assist
 - Rear Cross-Traffic Collision-Avoidance Assist
 - Reverse Parking Distance Warning
 - Parking Collision-Avoidance Assist
 - Remote Smart Parking Assist

For more information on each function, refer to chapter 7.

The tow hitch harness installed to your vehicle must be a genuine HYUNDAI parts. For more information, consult an authorized HYUNDAI dealer products.

- If a trailer or hitch mounted carrier is attached, it may adversely affect the performance of the rear corner radar.
- If a trailer, carrier or other attachment is installed around the rear corner radar, Blind-Spot Collision-Avoidance Assist, Safe Exit Warning, Rear Cross-Traffic Collision-Avoidance Assist may not operate properly, or it may operate unexpectedly.

If you decide to pull a trailer

Here are some important points if you decide to pull a trailer:

- Consider using a sway control. You can ask a trailer hitch dealer about sway control.
- Do not do any towing with your vehicle during its first 2,000 km (1,200 mi.) in order to allow the vehicle to properly break in. Failure to heed this caution may result in serious motor damage.
- When towing a trailer, we recommend to consult an authorized HYUNDAI dealer for further information on additional requirements such as towing kit etc.
- Always drive your vehicle at a moderate speed (less than 100 km/h (60 mph)) or posted towing speed limit.
- On a long uphill grade, do not exceed 70 km/h (45 mph) or the posted towing speed limit, whichever is lower.
- Carefully observe the weight and load limits provided in the following pages.

Trailer weight

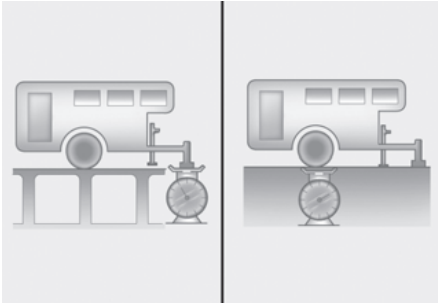

Tongue Load/Total Trailer Weight

What is the maximum safe weight of a trailer? It should never weigh more than the maximum trailer weight with trailer brakes. But even that can be too heavy. It depends on how you plan to use your trailer. For example, speed, altitude, road grades, outside temperature and how often your vehicle is used to pull a trailer are all important. The ideal trailer weight can also depend on any special equipment that you have on your vehicle.

Tongue load

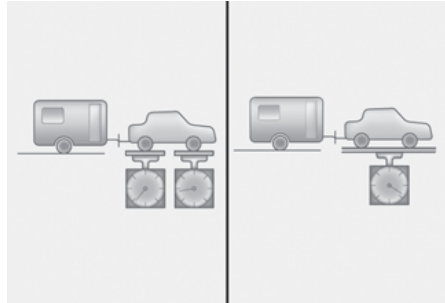

Gross Axle Weight/Gross Vehicle Weight

The tongue load is an important weight to measure because it affects the total Gross Vehicle Weight (GVW) of your vehicle. The trailer tongue should weigh a maximum of 10 % of the total loaded trailer weight, within the limits of the maximum trailer tongue load permissible. After you've loaded your trailer, weigh the trailer and then the tongue, separately, to see if the weights are proper. If they aren't, you may be able to correct them simply by moving some items around in the trailer.

WARNING

Take the following precautions:

- Never load a trailer with more weight in the rear than in the front. The front should be loaded with about 60 % of the total trailer load; the rear should be loaded with about 40 % of the total trailer load.
- Never exceed the maximum weight limits of the trailer or trailer towing equipment. Improper loading can result in damage to your vehicle and/or personal injury. Check weights and loading at a commercial scale or highway patrol office equipped with scales.

Reference weight and distance when towing a trailer (for Europe)

Item		Standard type	Extended type
Maximum trailer weight kg (lbs.)	With brake system	750 (1,653)	1,500 (3,306)
	Without brake system	750 (1,653)	750 (1,653)
Maximum permissible static vertical load on the coupling device kg (lbs.)		100 (220)	100 (220)
Recommended distance from rear wheel center to coupling point mm (in.)		1,155 (45)	1,155 (45)

Trailer towing equipment

Hitches

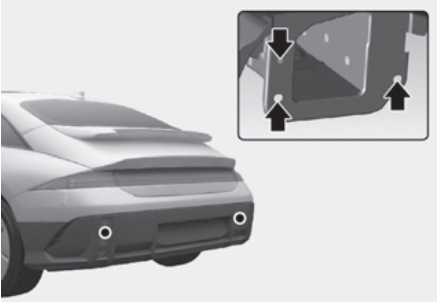

i Information

The mounting hole for hitches are located on both sides of the underbody behind the rear tires.

It's important to have the correct hitch equipment. Crosswinds, large trucks going by, and rough roads are a few reasons why you'll need the right hitch. Here are some rules to follow:

- Do you have to make any holes in the body of your vehicle when you install a trailer hitch? If you do, then be sure to seal the holes later when you remove the hitch. If you don't seal them, carbon monoxide (CO) from your exhaust can get into your vehicle, as well as dirt and water.

- The bumpers on your vehicle are not intended for hitches. Do not attach rental hitches or other bumper-type hitches to them. Use only a frame-mounted hitch that does not attach to the bumper.
- Any part of the rear number plate or lighting devices of the vehicle must not be obscured by the mechanical coupling device.

If the rear number plate and/or lighting devices can be obscured partially by any part of the mechanical coupling device, mechanical coupling devices that can not be easily removed or repositioned without use of any tools, except an easily operated (for example, an effort not exceeding 20 Nm) release key which is supplied by the manufacturer of the coupling device, are not permitted for use.

Please note that the mechanical coupling device that is fitted and not in use must always be removed or repositioned if the rear number plate and/or rear lighting devices are obscured by any part of the mechanical coupling device.

- A HYUNDAI trailer hitch accessory is available at an authorized HYUNDAI dealer.

Safety chains

You should always attach chains between your vehicle and your trailer.

Instructions about safety chains may be provided by the hitch manufacturer or trailer manufacturer. Follow the manufacturer's recommendation for attaching safety chains. Always leave just enough slack so you can turn with your trailer. And, never allow safety chains to drag on the ground.

Trailer brakes

If your trailer is equipped with a braking system, make sure it conforms to your country's regulations and that it is properly installed and operating correctly.

If your trailer weighs more than the maximum trailer weight without trailer brakes loaded, then it needs its own brakes and they must be adequate. Be sure to read and follow the instructions for the trailer brakes so you'll be able to install, adjust and maintain them properly. Be sure not to modify your vehicle's brake system.

WARNING

Do not use a trailer with its own brakes unless you are absolutely certain that you have properly set up the brake system. This is not a task for amateurs. Use an experienced, competent trailer shop for this work.

Driving with a trailer

Towing a trailer requires a certain amount of experience. Before setting out for the open road, you must get to know your trailer. Acquaint yourself with the feel of handling and braking with the added weight of the trailer. And always keep in mind that the vehicle you are driving is now longer and not nearly as responsive as your vehicle is by itself.

Before you start, check the trailer hitch and platform, safety chains, electrical connector(s), lights, tires and brakes.

During your trip, occasionally check to be sure that the load is secure, and that the lights and trailer brakes are still working.

i **Information**

When the ambient temperature is lower than 0 °C (32 °F) and the remaining high voltage battery is low, the power of the vehicle with a trailer can be dropped, causing a trouble in acceleration or drop of the speed when driving hills.

When driving with a trailer, be sure to charge the high voltage battery more than 50 % if the ambient temperature is lower than 0 °C (32 °F).

Distance

Stay at least twice as far behind the vehicle ahead as you would when driving your vehicle without a trailer. This can help you avoid situations that require heavy braking and sudden turns.

Passing

You will need more passing distance up ahead when you're towing a trailer. And, because of the increased vehicle length, you'll need to go much farther beyond the passed vehicle before you can return to your lane.

Backing up

Hold the bottom of the steering wheel with one hand. Then, to move the trailer to the left, move your hand to the left. To move the trailer to the right, move your hand to the right. Always back up slowly and, if possible, have someone guide you.

Making turns

When you're turning with a trailer, make wider turns than normal. Do this so your trailer won't strike soft shoulders, curbs, road signs, trees, or other objects. Avoid jerky or sudden maneuvers. Signal well in advance.

Turn signals

When you tow a trailer, your vehicle has to have a different turn signal flasher and extra wiring. The green arrows on your instrument panel will flash whenever you signal a turn or lane change. Properly connected, the trailer lights will also flash to alert other drivers you're about to turn, change lanes, or stop.

When towing a trailer, the green arrows on your instrument panel will flash for turns even if the bulbs on the trailer are burned out. Thus, you may think drivers behind you are seeing your signals when, in fact, they are not. It's important to check occasionally to be sure the trailer bulbs are still working. You must also check the lights every time you disconnect and then reconnect the wires.

WARNING

Do not connect a trailer lighting system directly to your vehicle's lighting system. Use an approved trailer wiring harness. Failure to do so could result in damage to the vehicle electrical system and/or personal injury. We recommend that you consult an authorized HYUNDAI dealer for assistance.

Driving on hills

Reduce speed before you start down a long or steep downgrade.

On a long uphill grade, reduce your speed to around 70 km/h (45 mph) to reduce the possibility of motor overheating.

NOTICE

To prevent motor overheating:

- If you tow a trailer with the maximum gross vehicle weight and maximum trailer weight, it can cause the motor to overheat. When driving in such conditions, allow the motor to idle until it cools down. You may proceed once the motor has cooled sufficiently.
- When towing a trailer, your vehicle speed may be much slower than the general flow of traffic, especially when climbing an uphill grade. Use the right hand lane when towing a trailer on an uphill grade. Choose your vehicle speed according to the maximum posted speed limit for vehicles with trailers, the steepness of the grade, and your trailer weight.

Parking on hills

Generally, if you have a trailer attached to your vehicle, you should not park your vehicle on a hill.

However, if you ever have to park your trailer on a hill, here's how to do it:

1. Pull the vehicle into the parking space. Turn the steering wheel in the direction of the curb (right if headed down hill, left if headed up hill).
2. Shift the gear to P (Park).

3. Set the parking brake and shut off the vehicle.
4. Place wheel chocks under the trailer wheels on the down hill side of the wheels.
5. Start the vehicle, hold the brakes, shift to neutral, release the parking brake and slowly release the brakes until the trailer chocks absorb the load.
6. Reapply the brakes and parking brakes.
7. Shift the gear to P (Park) when the vehicle is parked on a uphill grade and in R (Reverse) on a downhill.
8. Shut off the vehicle and release the vehicle brakes but leave the parking brake set.

⚠ WARNING

To prevent serious or fatal injury:

- Do not get out of the vehicle without the parking brake firmly set. If you have left the vehicle running, the vehicle can move suddenly. You and others could be seriously or fatally injured.
- Do not apply the accelerator pedal to hold the vehicle on an uphill.

Driving the vehicle after it has been parked on a hill

1. With the gear in P (Park), apply your brakes and hold the brake pedal down while you:
 - Start your vehicle;
 - Shift into gear; and
 - Release the parking brake.
2. Slowly remove your foot from the brake pedal.
3. Drive slowly until the trailer is clear of the chocks.
4. Stop and have someone pick up and store the chocks.

Maintenance when towing a trailer

Your vehicle will need service more often when you regularly pull a trailer. Important items to pay particular attention to include reduction gear fluid, axle lubricant and cooling system fluid. Brake condition is another important item to frequently check. If you're trailering, it's a good idea to review these items before you start your trip. Don't forget to also maintain your trailer and hitch. Follow the maintenance schedule that accompanied your trailer and check it periodically. Preferably, conduct the check at the start of each day's driving. Most importantly, all hitch nuts and bolts should be tight.

NOTICE

To prevent vehicle damage:

- Due to higher load during trailer usage, overheating might occur on hot days or during uphill driving.
 - When towing check reduction gear fluid more frequently.
-

Vehicle weight

Two labels on your driver's door sill show how much weight your vehicle was designed to carry: the Tire and Loading Information Label and the Certification Label.

Before loading your vehicle, familiarize yourself with the following terms for determining your vehicle's weight ratings, from the vehicle's specifications and the Certification Label:

Base Curb Weight

This is the weight of the vehicle including high voltage battery and all standard equipment. It does not include passengers, cargo, or optional equipment.

Vehicle Curb Weight

This is the weight of your new vehicle when you picked it up from your dealer plus any aftermarket equipment.

Cargo Weight

This figure includes all weight added to the Base Curb Weight, including cargo and optional equipment.

GAW (Gross Axle Weight)

This is the total weight placed on each axle (front and rear) - including vehicle curb weight and all payload.

GAWR (Gross Axle Weight Rating)

This is the maximum allowable weight that can be carried by a single axle (front or rear). These numbers are shown on the Certification Label. The total load on each axle must never exceed its GAWR.

GVW (Gross Vehicle Weight)

This is the Base Curb Weight plus actual Cargo Weight plus passengers.

GVWR (Gross Vehicle Weight Rating)

This is the maximum allowable weight of the fully loaded vehicle (including all options, equipment, passengers and cargo). The GVWR is shown on the Certification Label located on the driver's door sill.

Overloading **WARNING**

The Gross Axle Weight Rating (GAWR) and the Gross Vehicle Weight Rating (GVWR) for your vehicle are on the Certification Label attached to the driver's (or front passenger's) door. Exceeding these ratings can cause an accident or vehicle damage. You can calculate the weight of your load by weighing the items (and people) before putting them in the vehicle. Be careful not to overload your vehicle.

7. Driver assistance system

Driver assistance system notice.....	7-4
Forward Collision Avoidance Assist (FCA).....	7-4
Forward Collision-Avoidance Assist settings.....	7-9
Forward Collision-Avoidance Assist operation.....	7-12
Forward Collision-Avoidance Assist malfunction and limitations.....	7-24
Lane Keeping Assist (LKA).....	7-33
Lane Keeping Assist settings.....	7-34
Lane Keeping Assist operation.....	7-35
Lane Keeping Assist malfunction and limitations	7-37
Blind-Spot Collision-Avoidance Assist (BCA).....	7-40
Blind-Spot Collision-Avoidance Assist settings.....	7-42
Blind-Spot Collision-Avoidance Assist operation.....	7-43
Blind-Spot Collision-Avoidance Assist malfunction and limitations.....	7-47
Safe Exit Warning (SEW).....	7-52
Safe Exit Warning settings	7-53
Safe Exit Warning operation.....	7-54
Safe Exit Warning malfunction and limitations	7-55
Manual Speed Limit Assist (MSLA).....	7-57
Manual Speed Limit Assist operation.....	7-57
Intelligent Speed Limit Assist (ISLA)	7-59
Intelligent Speed Limit Assist settings	7-60
Intelligent Speed Limit Assist operation	7-62
Intelligent Speed Limit Assist malfunction and limitations	7-64
Driver Attention Warning (DAW).....	7-66
Driver Attention Warning settings	7-67
Driver Attention Warning operation	7-68
Driver Attention Warning malfunction and limitations.....	7-69
Blind-Spot View Monitor (BVM).....	7-72
Blind-Spot View Monitor settings.....	7-73
Blind-Spot View Monitor Operation	7-73
Blind-Spot View Monitor malfunction.....	7-74
Cruise Control (CC).....	7-74
Cruise Control operation	7-74
Smart Cruise Control (SCC)	7-78
Smart Cruise Control settings.....	7-79

Smart Cruise Control operation	7-80
Smart Cruise Control malfunction and limitations	7-91
Navigation-Based Smart Cruise Control (NSCC).....	7-97
Navigation-based Smart Cruise Control settings	7-97
Navigation-based Smart Cruise Control operation	7-98
Limitations of Navigation-based Smart Cruise Control	7-99
Lane Following Assist (LFA).....	7-102
Lane Following Assist settings	7-103
Lane Following Assist operation	7-103
Lane Following Assist Malfunction and Limitations	7-106
Highway Driving Assist (HDA).....	7-107
Highway Driving Assist settings	7-108
Highway Driving Assist operation	7-110
Highway Driving Assist Malfunction and Limitations	7-118
Rear View Monitor (RVM).....	7-120
Rear View Monitor settings	7-120
Rear View Monitor operation	7-121
Rear View Monitor malfunction and limitations	7-123
Surround View Monitor (SVM)	7-124
Surround View Monitor settings	7-124
Surround View Monitor operation.....	7-126
Surround View Monitor malfunction and limitations	7-129
Rear Cross-Traffic Collision-Avoidance Assist (RCCA)	7-130
Rear Cross-Traffic Collision-Avoidance Assist settings.....	7-131
Rear Cross-Traffic Collision-Avoidance Assist operation.....	7-132
Rear Cross-Traffic Collision-Avoidance Assist malfunction and limitations	7-135
Forward/Reverse Parking Distance Warning (PDW)	7-141
Forward/Reverse Parking Distance Warning settings	7-141
Forward/Reverse Parking Distance Warning operation.....	7-142
Forward/Reverse Parking Distance Warning malfunction and limitations.....	7-144
Forward/Side/Reverse Parking Distance Warning (PDW)	7-146
Parking Distance Warning Settings.....	7-147
Parking Distance Warning Operation	7-147
Parking Distance Warning Malfunction and Limitations	7-150
Reverse Parking Collision-Avoidance Assist (PCA)	7-153

7. Driver assistance system

Reverse Parking Collision-Avoidance Assist settings	7-154
Reverse Parking Collision-Avoidance Assist operation.....	7-155
Reverse Parking Collision-Avoidance Assist malfunction and limitations	7-156
Forward/Side/Reverse Parking Collision-Avoidance Assist (PCA)	7-161
Parking Collision-Avoidance Assist settings	7-161
Parking Collision-Avoidance Assist operation	7-163
Parking Collision-Avoidance Assist malfunction and limitations	7-165
Remote Smart Parking Assist 2 (RSPA 2)	7-169
Remote Smart Parking Assist settings	7-171
Remote Smart Parking Assist operation.....	7-172
Remote Smart Parking Assist malfunction and limitations	7-190
Declaration of conformity.....	7-197
Front radar.....	7-197
Front corner radar/Rear corner radar.....	7-200

Driver assistance system notice

Due to the infotainment software update, the description of each function of the driver assistance system may differ from the owner's manual.

Forward Collision Avoidance Assist (FCA)

 If equipped

Basic function

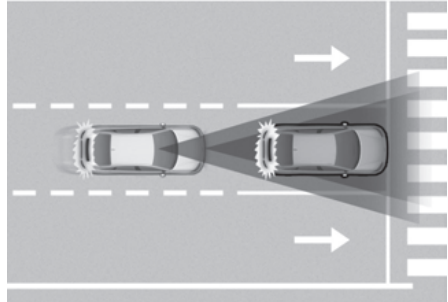

Forward Collision-Avoidance Assist detects a vehicle, a powered-two wheeler, a pedestrian, or a cyclist ahead on the road and may warn you of a possible collision with a warning message on the instrument cluster and a warning sound. Also, Forward Collision-Avoidance Assist may assist with braking your vehicle to help reduce collision speed or avoid a collision.

In addition, when driving at high speeds, Forward Collision-Avoidance Assist will help detect vehicles in front and adjacent lanes. If a collision is imminent when changing lanes, Forward Collision Avoidance Assist will apply emergency braking to help prevent a collision. (if equipped)

Junction Turning function

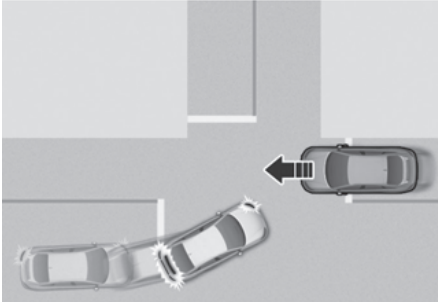

Junction Turning function can help avoid a collision with an oncoming vehicle or powered two-wheeler in an adjacent lane when turning left (left-hand drive) or right (right-hand drive) at a crossroad with the turn signal on by applying emergency braking.

Direct Oncoming function

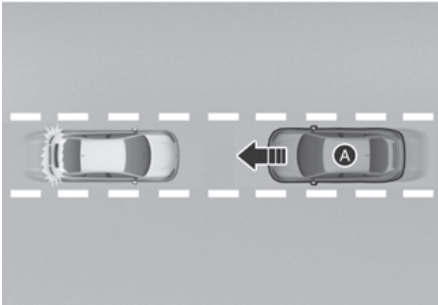

[A] Oncoming vehicle

Direct Oncoming function helps reduce the speed at the collision when a vehicle or powered two-wheeler approaching from the opposite side is detected.

Junction Crossing function

+ if equipped

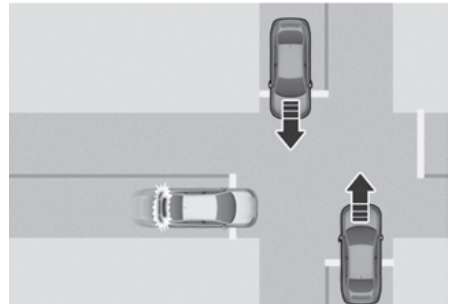

Junction Crossing function can help avoid a collision with oncoming vehicles on the left or right side when crossing an intersection by applying emergency braking.

Lane-Change Oncoming function

+ if equipped

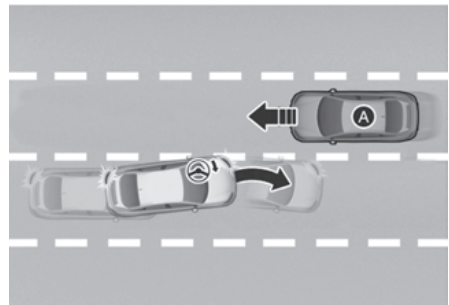

[A] Oncoming vehicle

Lane-Change Oncoming function helps avoid a collision with an oncoming vehicle or powered two-wheeler when changing lanes by assisting the driver's steering.

Lane-Change Side function

 if equipped

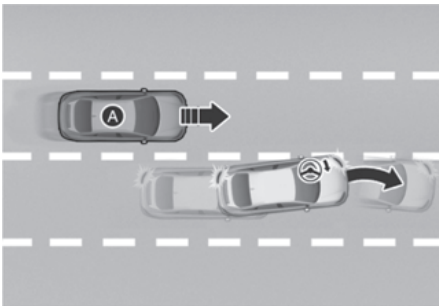
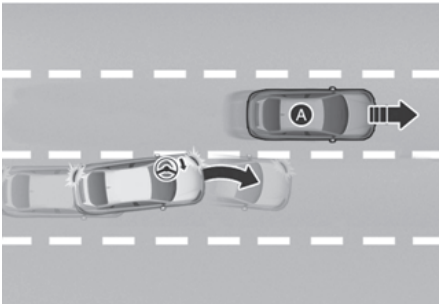

[A] Front-side vehicle

Lane-Change Side function helps avoid a collision with the vehicle or powered two-wheeler in the next lane when changing lanes by assisting the driver's steering.

Evasive Steering Assist function

 if equipped

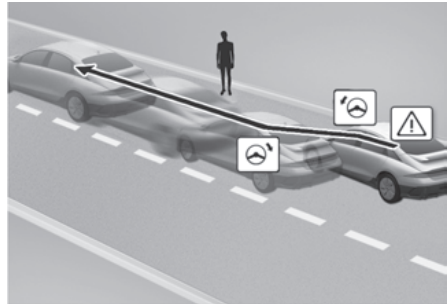

- Driver steering assist

Evasive Steering Assist function helps avoid a collision with a vehicle or powered two-wheeler, pedestrian or cyclist ahead in the same lane. When a risk of collision is detected, Evasive Steering Assist function will warn the driver and if the driver steers to avoid collision it will assist the driver's steering.

- Evasive steering assist

Evasive Steering Assist function helps avoid a collision with a powered two-wheeler, pedestrian or cyclist ahead in the same lane. When a risk of collision is detected, Evasive Steering Assist function will warn the driver and if there is space to avoid collision in the lane, it will assist the driver's steering.

Evasive Steering Assist function operates when there is a collision risk and sufficient operating area between your vehicle and the detected pedestrian or cyclist ahead.

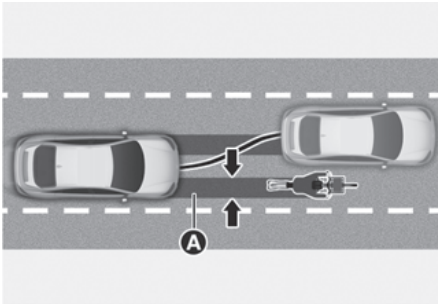

[A] Operating Area of Evasive Steering Assist function

Detecting sensor

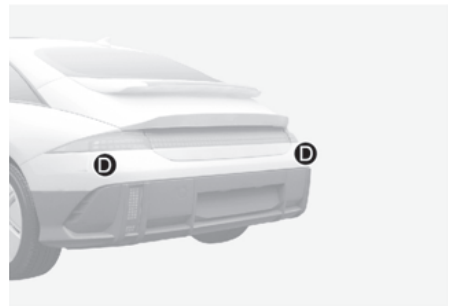
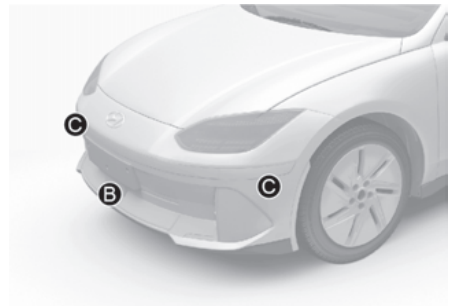

- [A] Front view camera
- [B] Front radar
- [C] Front corner radar (if equipped)
- [D] Rear corner radar (if equipped)

Refer to the picture above for the detailed location of the detecting sensors.

CAUTION

Take the following precautions to maintain optimal performance of the detecting sensor:

- Never disassemble the detecting sensor or sensor assembly, or cause any damage to it.
 - If the detecting sensors have been replaced or repaired, we recommend that you have the vehicle inspected by an authorized HYUNDAI dealer.
 - Never install any accessories or stickers on the front windshield, or tint the front windshield.
 - Exercise extreme caution to keep the front view camera dry.
 - Never place any reflective objects (for example, white paper, mirror) over the dashboard.
 - Do not place any objects near the front windshield or install any accessories on the front windshield. It can affect the performance of the defogging and defrosting function of the climate control system, which may prevent the Driver Assistance systems from operating.
 - Do not apply license plate frame or objects, such as a bumper sticker, film or a bumper guard, near the front radar cover.
 - Do not change the position of the license plate. The front radar's detection and control performance may be affected.
 - Always keep the front radar and cover clean and free of dirt and debris. Use only a soft cloth to wash the vehicle. Do not spray pressurized water directly on the sensor or sensor cover.
 - If the radar or around the radar has been damaged or impacted in any way, Forward Collision-Avoidance Assist may not properly operate even though a warning message does not appear on the instrument cluster. we recommend that you have the vehicle inspected by an authorized HYUNDAI dealer.
 - Use only genuine parts to repair or replace a damaged front radar cover. Do not apply paint to the front radar cover.
 - Vehicles equipped with front corner radar and/or rear corner radar
 - Do not apply license plate frame or objects, such as a bumper sticker, film or a bumper guard, near the front corner radar or rear corner radar.
 - The function may not work properly when the bumper has been replaced, or the surroundings of the front corner radar or rear corner radar has been damaged or paint has been applied.
 - If a trailer, carrier, etc., is installed, it may adversely affect the performance of the rear corner radar or Forward Collision-Avoidance Assist may not operate properly.
-

Forward Collision-Avoidance Assist settings

Forward Safety

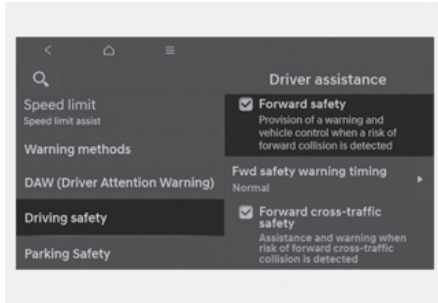

With the vehicle on, select or deselect **Setup (Settings) > Vehicle > Driver assistance > Driving safety > Forward safety** from the Settings menu to set whether to use each function.

- If Forward Safety is selected, Forward Collision-Avoidance Assist will warn the driver with a warning message, an audible warning depending on the collision risk levels. Braking assist will be applied depending on the collision risk levels. If Forward Safety is deselected, Forward Safety will turn off. The warning light (⚠️) will illuminate on the instrument cluster.

Forward Cross-Traffic Safety

⁺if equipped

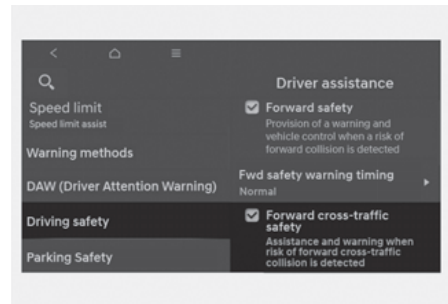

With the vehicle on, select **Setup (Settings) > Vehicle > Driver assistance > Driving safety > Forward cross-traffic safety** from the Settings menu to turn on Junction crossing function and deselect to turn off the function.

Forward/Side Safety

 if equipped

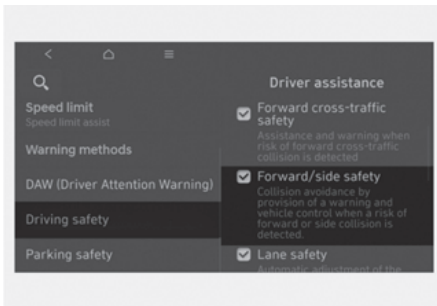

With the vehicle on, select **Setup (Settings) > Vehicle > Driver assistance > Driving safety > Forward/side safety** from the Settings menu to turn on Junction crossing function and deselect to turn off the function.

- If 'Forward/side Safety' is selected, Forward Collision-Avoidance Assist will warn the driver, steering wheel vibration, a warning message, an audible warning depending on the collision risk levels. Braking assist will be applied depending on the collision risk levels. If 'Forward/Side Safety' is deselected, Forward/Side Safety will turn off. The warning light () will illuminate on the instrument cluster.

WARNING

When the vehicle is restarted, Forward Collision-Avoidance Assist will always turn on. However, if '**Forward Safety**' is deselected, the driver should always be aware of the surroundings and drive safely.

CAUTION

- The setting for Forward Safety include 'Basic function' and 'Junction Turning', and 'Direct Oncoming'.
- The setting for Forward-Cross Traffic Safety includes 'Junction Crossing'.
- The setting for Forward/Side Safety includes 'Lane Change Oncoming', 'Lane-Change Side' and 'Evasive Steering Assist' (if equipped).
- If '**Forward Safety**' is deselected, Junction Crossing function will not operate even when '**Forward Cross-Traffic Safety**' and '**Forward/Side Safety**' is selected. (if equipped)

Forward Safety Warning Timing

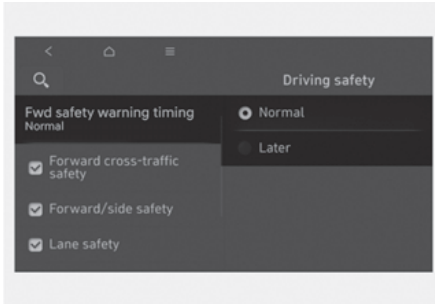

With the vehicle on, select **Setup (Settings) > Vehicle > Driver assistance > Driving safety > Forward safety warning timing** from the Settings menu to change the initial warning activation time for Forward Collision Avoidance Assist. The warning time can be set to either '**Standard (Normal)**' or '**Late (Later)**'.

- Use '**Standard (Normal)**' in normal driving conditions. If the Warning Timing seems sensitive, change it to '**Late**'.
- If '**Late (Later)**' is selected, Forward Collision-Avoidance Assist, warns the driver more slowly.

CAUTION

- Even though '**Standard**' is selected for Warning Timing, if a detected vehicle in front suddenly stops, the warning may seem late.
- Select '**Late**' for Warning Timing when traffic is light and when driving speed is slow.

Information

- If you change the Warning timing, the Warning timing of other Driver assistance systems may change.
- If the vehicle is restarted, Warning timing will maintain the last setting.

Warning Methods

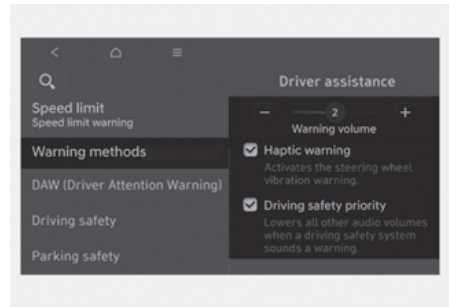

With the vehicle on, go to **Setup > Vehicle > Driver assistance > Warning methods (select speaker icon)** from the Settings in the infotainment system to select the following:

- **Warning volume:** The Warning volume can be adjusted.
If you turn off the Warning Volume, for your safety, the function may warn you with a low volume.
- **Haptic warning:** The steering wheel vibration can be set.(if equipped)
- **Driving safety priority:** Your vehicle lowers all other audio volumes when the Driver Assistance system warning sounds.

i Information

- If you change the Warning methods, Warning methods of other Driver Assistance systems may change.
- If the vehicle is restarted, Warning methods will maintain the last setting.
- There may be no settings menu depending on the feature applied to your vehicle.
- The Warning Volume and Haptic Warning cannot be turned off at the same time. When one of the warning is turned off the other is activated.

Forward Collision-Avoidance Assist operation

Basic function

The basic function for Forward Collision-Avoidance Assist is to warn and help control the vehicle depending on the collision risk level: 'Collision Warning', 'Emergency Braking' and 'Stopping vehicle and ending brake control'.

Collision Warning

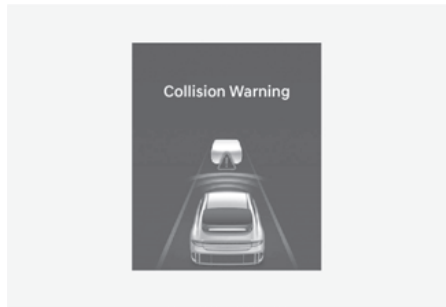

- To warn the driver of a collision, Forward Safety warning light (⚠️) blinking, the '**Collision Warning**' warning message will appear on the instrument cluster, an audible warning will sound and the steering wheel will vibrate.
- If a vehicle or powered two-wheeler is detected in front, the function will operate when your vehicle speed is between about 10-200 km/h (6-124 mph).
- If a pedestrian or cyclist is detected in front, the function will operate when your vehicle speed is between about 10-85 km/h (6-53 mph).

Emergency Braking

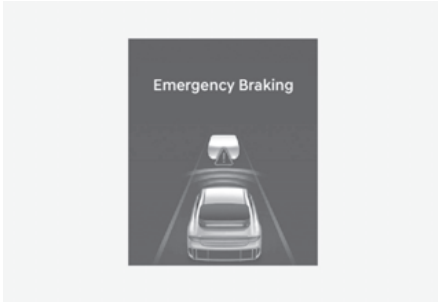

To warn the driver that emergency braking will be assisted, Forward Safety warning light (⚠️) blinking, the '**Emergency Braking**' warning message will appear on the instrument cluster, an audible warning will sound and the steering wheel will vibrate.

Emergency braking will operate under the following conditions.

- Vehicle of powered two-wheeler:

	Driving vehicle	Stopped vehicle
Weak braking power	about 10-200 km/h (6-124 mph)	
Strong braking power	about 10-130 km/h (6-80 mph)	about 10-75 km/h (6-47 mph)
		about 10-100 km/h (6-62 mph)*

*: If Forward Collision Avoidance Assist judges that avoiding a collision is difficult even by changing the driving lane, braking is assisted more earlier.

- Pedestrian or cyclist:

The function will operate when your vehicle speed is between about 10-65 km/h (6-40 mph).

Stopping vehicle and ending brake control



- When the vehicle is stopped due to emergency braking, the '**Drive carefully**' warning message will appear on the instrument cluster.

For your safety, the driver should depress the brake pedal immediately and check the surroundings.

- Brake control will end after the vehicle is stopped by emergency braking for about 2 seconds.

i Information

Press the hazard warning flasher to turn off the audible warning of the collision warning or emergency braking system.

Junction Turning function

Junction Turning function will warn and help control the vehicle depending on the collision risk level: 'Collision Warning', 'Emergency Braking' and 'Stopping vehicle and ending brake control'

Collision Warning

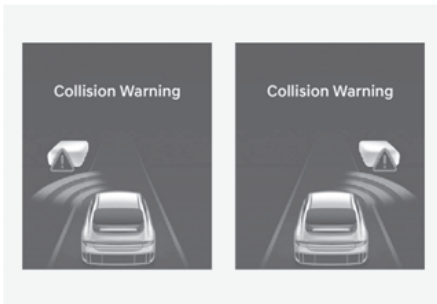

- To warn the driver of a collision, Forward Safety warning light (⚠️) blinking, the **'Collision Warning'** warning message will appear on the instrument cluster, an audible warning will sound and the steering wheel will vibrate.
- The function will operate when your vehicle speed is between about 10-30 km/h (6-19 mph) and the oncoming vehicle or powered two-wheeler speed is between about 30-70 km/h (19-44 mph).

Emergency Braking

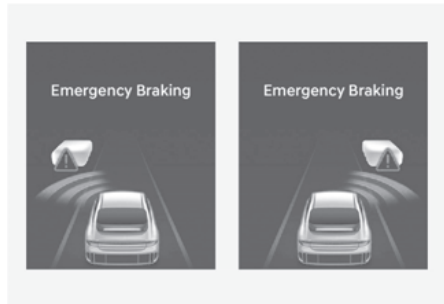

- To warn the driver that emergency braking will be assisted, Forward Safety warning light (⚠️) blinking, the **'Emergency Braking'** warning message will appear on the instrument cluster, an audible warning will sound and the steering wheel will vibrate.
- In emergency braking situation, braking is assisted with strong braking power by the function to help prevent collision with the oncoming vehicle.
- The function will operate when your vehicle speed is between about 10-30 km/h (6-19 mph) and the oncoming vehicle or powered two-wheeler speed is between about 30-70 km/h (19-44 mph).

i Information

If the driver's seat is on the left side, Junction Turning function will operate only when you turn left. If the driver's seat position is on the right side, the function will operate only when you turn right.

Stopping vehicle and ending brake control



- When the vehicle is stopped due to emergency braking, the '**Drive carefully**' warning message will appear on the instrument cluster.

For your safety, the driver should depress the brake pedal immediately and check the surroundings.

- Brake control will end after the vehicle is stopped by emergency braking for about 2 seconds.

i Information

Press the hazard warning flasher to turn off the audible warning of the collision warning or emergency braking system.

Direct Oncoming function

Direct Oncoming function will warn and control the vehicle depending on the collision risk level: 'Collision Warning', 'Emergency Braking' and 'Stopping vehicle and ending brake control'.

Collision Warning

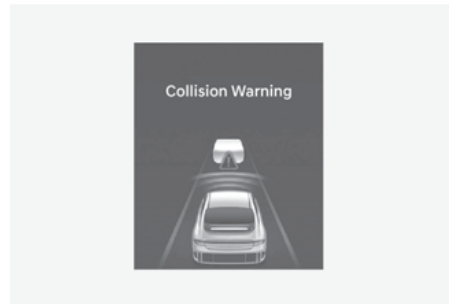

- To warn the driver of a collision, Forward Safety warning light (🚦) blinking, the '**Collision Warning**' warning message will appear on the instrument cluster, an audible warning will sound and the steering wheel will vibrate.
- The function will operate when your vehicle speed is between about 30-130 km/h (19-80 mph) and the detected oncoming vehicle speed is about above 10 km/h (6 mph) and the oncoming motorcycle speed is about above 25 km/h (16 mph).

Emergency Braking

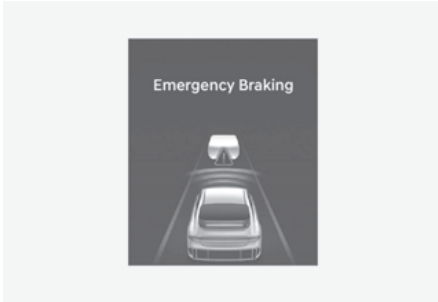

- To warn the driver that emergency braking will be assisted, Forward Safety warning light (⚠️) blinking, the '**Emergency Braking**' warning message will appear on the instrument cluster, an audible warning will sound and the steering wheel will vibrate.
- In emergency braking situation, braking is assisted with strong braking power by the function to help prevent collision with the oncoming vehicle.
- The function will operate when your vehicle speed is between about 30-130 km/h (19-80 mph) and the detected oncoming vehicle speed is about above 10 km/h (6 mph).

Stopping vehicle and ending brake control



- When the vehicle is stopped due to emergency braking, the '**Drive carefully**' warning message will appear on the instrument cluster. For your safety, the driver should depress the brake pedal immediately and check the surroundings.
- Brake control will end after the vehicle is stopped by emergency braking for about 2 seconds.

⚠️ CAUTION

If your vehicle or the oncoming vehicle is not driving straight, Direct Oncoming function warning and control may be late or may not operate.

i Information

Press the hazard warning flasher to turn off the audible warning of the collision warning or emergency braking system.

Junction Crossing function

+ if equipped

Junction Crossing function will warn and control the vehicle depending on collision risk level: '**Collision Warning**', '**Emergency Braking**' and '**Stopping vehicle and ending brake control**'

Collision Warning

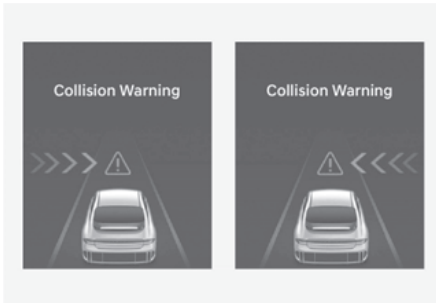

- To warn the driver of a collision, Forward Safety warning light (🚨) blinking, the '**Collision Warning**' warning message will appear on the instrument cluster, an audible warning will sound and the steering wheel will vibrate.
- The function will operate when your vehicle speed is between about 10-55 km/h (6-34 mph) and the crossing vehicle speed is between about 10-60 km/h (6-37 mph).

Emergency Braking

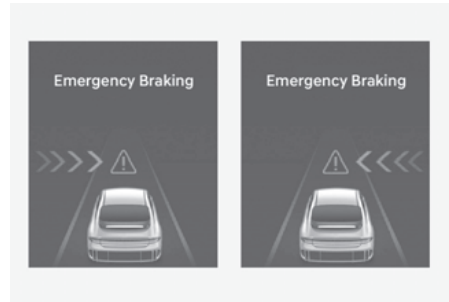

- To warn the driver that emergency braking will be assisted, Forward Safety warning light (🚨) blinking, the '**Emergency Braking**' warning message will appear on the instrument cluster, an audible warning will sound and the steering wheel will vibrate.
- In emergency braking situation, braking is assisted with strong braking power by the function to help prevent collision with the crossing vehicle.
- The function will operate when your vehicle speed is between about 10-55 km/h (6-34 mph) and the crossing vehicle speed is between about 10-40 km/h (6-25 mph).

Stopping vehicle and ending brake control



- When the vehicle is stopped due to emergency braking, the '**Drive carefully**' warning message will appear on the instrument cluster.

For your safety, the driver should depress the brake pedal immediately and check the surroundings.

- Brake control will end after the vehicle is stopped by emergency braking for about 2 seconds.

CAUTION

If your vehicle or the oncoming vehicle is not driving straight, Front Oncoming function warning and control may be late or may not operate.

Information

Press the hazard warning flasher to turn off the audible warning of the collision warning or emergency braking system.

Lane-Change Oncoming function

 **if equipped**

Lane-Change Oncoming function will warn and control the vehicle depending on collision risk level: 'Collision Warning' and 'Emergency Steering'

Collision Warning



- To warn the driver of a collision, Emergency Steering warning light () blinking, the '**Collision Warning**' warning message will appear on the instrument cluster, an audible warning will sound and the steering wheel will vibrate.
- The function will operate when your vehicle speed is between about 40-145 km/h (25-90 mph) and the oncoming vehicle or powered two-wheeler speed is about above 10 km/h (6 mph) and the relative speed with your vehicle is about below 200 km/h (124 mph).

Emergency Steering

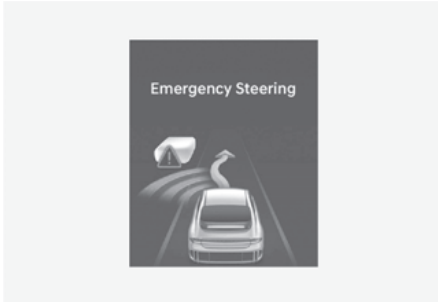

- To warn the driver that emergency steering will be assisted, Emergency Steering warning light (🚗) blinking, the **'Emergency Steering'** warning message will appear on the instrument cluster, an audible warning will sound and the steering wheel will vibrate.
- In emergency steering situation, steering is assisted by the function to help prevent collision with the oncoming vehicle.
- The function will operate when your vehicle speed is between about 40-145 km/h (25-90 mph) and the oncoming vehicle or powered two-wheeler speed is about above 10 km/h (6 mph) and the relative speed with your vehicle is about below 200 km/h (124 mph).

Lane-Change Side function

+ if equipped

Lane-Change Side function will warn and control the vehicle depending on collision risk level: 'Collision Warning' and 'Emergency Steering'

Collision Warning

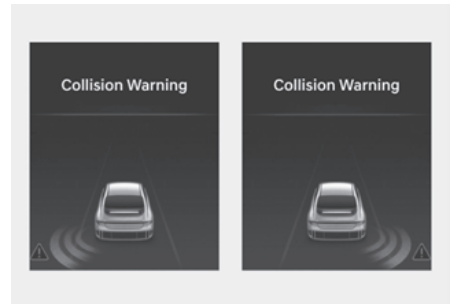
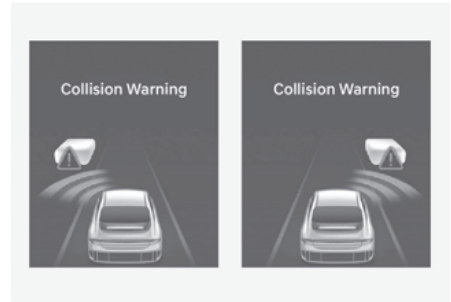

- To warn the driver of a collision, Emergency Steering warning light (🚗) blinking, the **'Collision Warning'** warning message will appear on the instrument cluster, an audible warning will sound and the steering wheel will vibrate.
- The function will operate when your vehicle speed is between about 40-145 km/h (25-90 mph).

Emergency Steering

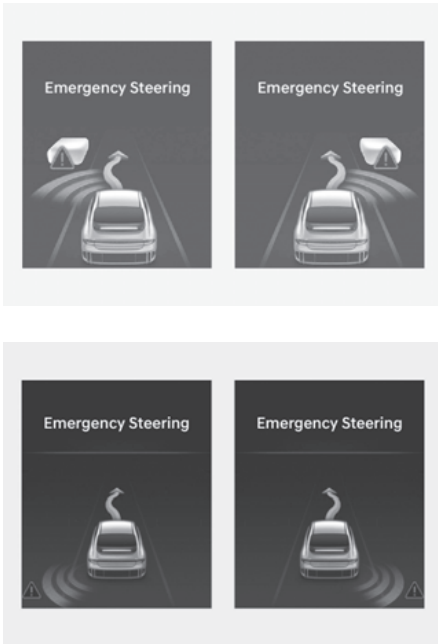

- To warn the driver that emergency steering will be assisted, Emergency Steering warning light (🚨) blinking, the 'Emergency Steering' warning message will appear on the instrument cluster, an audible warning will sound and the steering wheel will vibrate.
- In emergency steering situation, steering is assisted by the function to help prevent collision with the front-side vehicle.
- The function will operate when your vehicle speed is between about 40-145 km/h (25-90 mph) and front-side vehicle and powered two-wheeler is driving.

⚠ CAUTION

- Lane-Change Side function does not operate if the vehicle or powered two-wheeler speed of the preceding vehicle from the front side is 0 km/h (0 mph).
- The detecting range of the front corner radar and the rear corner radar is determined by a standard road width, therefore, on a narrow road, Lane-Change Side function may detect other vehicles or powered two-wheelers two lanes over and warn you. In contrast, on a wide road, Lane-Change Side function may not be able to detect a vehicle or powered two-wheeler driving in the next lane and may not warn you.
- Collision-avoidance assist will be canceled under the following circumstances:
 - Your vehicle enters the next lane by a certain distance
 - Your vehicle is away from the collision risk
 - The steering wheel is sharply steered
 - The brake pedal is depressed
 - Forward Collision-avoidance assist is operating
- After Lane-Change Side function operation or lane change, you must drive to the center of the lane. Lane-Change Side function will not operate if the vehicle is not driven in the center of the lane.

i Information

- When an additional accident is expected, Lane-Change Side function will not assist with steering and only warn the driver of a collision.
- If the driver's seat is on the left side, collision warning will operate when you turn left, and when it is on the right side, the system will operate when you turn right.
- If there is a risk of collision with a vehicle, powered two-wheeler pedestrian and cyclist in front, the steering will be assisted to help prevent collision when the driver steers the vehicle to avoid collision.
- The function will operate when your vehicle speed is between about 40-85 km/h (25-53 mph).

Evasive Steering Assist function

+ if equipped

Evasive Steering Assist function will warn and control the vehicle with 'Emergency steering'.

Emergency Steering (Driver steering assist)

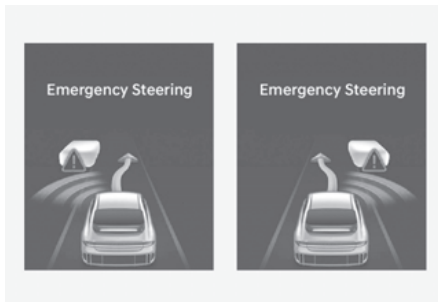

- To warn the driver that emergency steering will be assisted, Emergency Steering warning light (🚗) blinking, the '**Emergency Steering**' message will appear on the instrument cluster, an audible warning will sound and the steering wheel will vibrate.

Emergency Steering (Evasive steering assist)

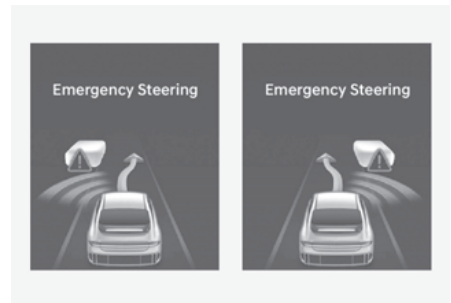

- To warn the driver that emergency steering will be assisted, Emergency Steering warning light (🚗) blinking, the '**Emergency Steering**' message will appear on the instrument cluster, an audible warning will sound and the steering wheel will vibrate.
- The recognized pedestrian or cyclist moves in the same direction as your vehicle, or in the opposite direction. In addition, there is sufficient space for an evasive movement for your vehicle. However, this function may not operate for pedestrians or cyclists moving in the horizontal direction.

- If there is high risk of collision with a powered two-wheeler, pedestrian and cyclist in front, and the vehicle speed to operate emergency braking is within the operation range, the steering will be assisted to help prevent collision when there is space to avoid collision in the driving lane.
- The function will operate when your vehicle speed is between about 65-75 km/h (40-47 mph).

CAUTION

- The steering wheel may turn automatically when emergency steering is operating.
 - Emergency steering will automatically cancel when risk factors disappear. If necessary, the driver must steer the vehicle.
 - Emergency steering may not operate or may cancel during operation if the steering wheel is held tight or steered in the opposite direction.
 - When steering is assisted to avoid collision with a vehicle, powered two-wheeler, pedestrian and cyclist, Evasive steering assist will be cancelled if collisions with other objects (vehicles, powered two-wheeler, pedestrians, or cyclists) are expected.
 - Evasive steering assist may not operate if space to avoid collision in the driving lane is insufficient.
-

Information

For more information on warning messages, refer to Collision Warning in "Basic function" section in this chapter.

WARNING

Take the following precautions when using Forward Collision-Avoidance Assist:

- For your safety, only change the Settings after parking the vehicle at a safe location.
- Forward Collision-Avoidance Assist does not operate in all situations or cannot avoid all collisions.
- The driver has the responsibility to control the vehicle. Do not solely depend on Forward Collision-Avoidance Assist. Rather, maintain a safe braking distance, and if necessary, depress the brake pedal to reduce driving speed or to stop the vehicle.
- Never deliberately operate Forward Collision-Avoidance Assist on people, objects, etc. It may cause serious injury or death.
- Forward Collision-Avoidance Assist may not operate if the driver depresses the brake pedal to avoid collision.

- Depending on the road and driving conditions, Forward Collision-Avoidance Assist may warn the driver late or may not warn the driver.
 - During Forward Collision-Avoidance Assist operation, the vehicle may stop suddenly injuring passengers and shifting loose objects. Always have the seat belt on and keep loose objects secured.
 - If any other system's warning message is displayed or audible warning is generated, Forward Collision-Avoidance Assist warning message may not be displayed and audible warning may not be generated.
 - You may not hear the warning sound of Forward Collision-Avoidance Assist if the surrounding is noisy.
 - Forward Collision-Avoidance Assist may turn off or may not operate properly or may operate unnecessarily depending on the road conditions and the surroundings.
 - Even if there is a problem with Forward Collision-Avoidance Assist, the vehicle's basic braking performance will operate properly.
 - During emergency braking, braking control by Forward Collision-Avoidance Assist will automatically cancel when the driver excessively depresses the accelerator pedal or sharply steers the vehicle.
-

CAUTION

- Depending on the condition of the vehicle, two-wheeled vehicle, pedestrian or cyclist in front and the surroundings, the speed range for Forward Collision-Avoidance Assist to operate may be reduced, and Forward Collision-Avoidance Assist may be limited, or may not operate.
 - Forward Collision-Avoidance Assist will operate under certain conditions by judging the risk level based on the condition of the oncoming vehicle or powered two-wheeler, driving direction, speed and surroundings.
 - Forward Collision-Avoidance Assist may be limited or disabled if the vehicle or powered two-wheeler speed is too high or the distance to the vehicle ahead is far.
 - When a collision with a surrounding vehicle is expected, Lane-Change Oncoming, Lane-Change Side and Evasive Steering Assist will not assist you with steering but only warn the you of a collision (if equipped).
-

i Information



- In a situation where collision is imminent, braking may be assisted by Forward Collision-Avoidance Assist when braking is insufficient by the driver.
 - The images and colors in the instrument cluster may differ depending on the cluster type or theme selected from the settings menu.
-

Forward Collision-Avoidance Assist malfunction and limitations

Forward Collision-Avoidance Assist malfunction

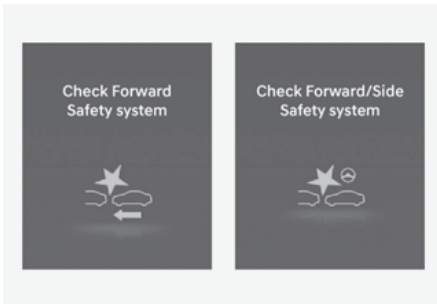
Type A/Type B



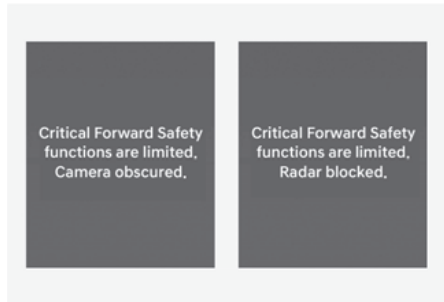

When Forward Collision-Avoidance Assist is not working properly, the '**Check Forward Safety system(s)**' and '**Check Forward/Side Safety system(s)**' warning message will appear, and the ,  and  warning lights will illuminate on the instrument cluster. We recommend that you have the vehicle inspected by an authorized HYUNDAI dealer.

Forward Collision-Avoidance Assist disabled



When the front windshield where the front view camera is located, front radar cover, bumper (if equipped) or sensor is covered with foreign material, such as snow or rain, it can reduce the detecting performance and temporarily limit or disable Forward Collision-Avoidance Assist.

If this occurs the '**Critical Forward Safety system(s) disabled. Camera obscured**' or the '**Critical Forward Safety system(s) disabled. Radar blocked**' warning message, and the ,  and  warning lights will illuminate on the instrument cluster.

Forward Collision-Avoidance Assist will operate properly when snow, rain or foreign material is removed.

If Forward Collision-Avoidance Assist does not operate properly after obstruction (snow, rain, or foreign material) is removed (including trailer, carrier, etc., from the rear bumper), we recommend that you have the vehicle inspected by an authorized HYUNDAI dealer.

WARNING

- Even though the warning message or warning light does not appear on the instrument cluster, Forward Collision-Avoidance Assist may not properly operate.
- Forward Collision-Avoidance Assist may not properly operate in an area (for example, open terrain), where any objects are not detected after turning ON the vehicle.
- If the vehicle is turned off and restarted while the camera is blocked or malfunctioned, the condition is maintained. Therefore, Forward Collision-Avoidance Assist may not operate properly.
- Driving in heavy rain or snow, or thick fog
- The field of view of the front view camera is obstructed by sun glare
- Street light or light from an oncoming traffic is reflected on the wet road surface, such as a puddle on the road
- An object is placed on the dashboard
- Your vehicle is being towed
- The surrounding is very bright
- The surrounding is very dark, such as in a tunnel, etc.
- The brightness changes suddenly, for example when entering or exiting a tunnel
- The brightness outside is low, and the headlights are not on or are not bright
- Driving through steam, smoke or shadow
- Only part of the vehicle, powered two-wheeler pedestrian or cyclist is detected
- The vehicle or powered two-wheeler in front is a bus, heavy truck, truck with an unusually shaped cargo, trailer, etc.
- The vehicle or powered two-wheeler in front has no tail lights, tail lights are located unusually, etc.
- The brightness outside is low, and the tail lights are not on or are not bright
- The rear of the front vehicle is small or the vehicle does not look normal, such as when the vehicle is tilted, overturned, or the side of the vehicle is visible, etc.
- The front vehicle's ground clearance is low or high

Limitations of Forward Collision-Avoidance Assist

Forward Collision-Avoidance Assist may not operate properly, or it may operate unexpectedly under the following circumstances:

- The detecting sensor or the surroundings are contaminated or damaged
- The temperature around the front view camera is high or low due to surrounding environment
- The camera lens is contaminated due to tinted, filmed or coated windshield, damaged glass, or sticky foreign material (sticker, bug, etc.) on the glass
- Moisture is not removed or frozen on the windshield
- Washer fluid is continuously sprayed, or the wiper is on

- A vehicle, powered two-wheeler, pedestrian or cyclist suddenly cuts in front
- The bumper around the front radar is impacted, damaged or the front radar is out of position
- The temperature around the front radar is high or low
- Driving through a tunnel or iron bridge
- Driving in vast areas where there are few vehicles or structures (for example, desert, meadow, suburb, etc.)
- Driving near areas containing metal substances, such as a construction zone, railroad, etc.
- A material is near that reflects very well on the front radar, such as a guardrail, nearby vehicle, etc.
- The cyclist in front is on a bicycle made of material that does not reflect on the front radar
- The vehicle or powered two-wheeler in front is detected late
- The vehicle or powered two-wheeler in front is suddenly blocked by an obstacle
- The vehicle or powered two-wheeler in front suddenly changes lane or suddenly reduces speed
- The vehicle or powered two-wheeler in front is bent out of shape
- The vehicle in front is covered with snow
- You are departing or returning to the lane
- Unstable driving

- You are on a roundabout and the vehicle or powered two-wheeler in front is not detected
- You are continuously driving in a circle
- The vehicle in front has an unusual shape
- The vehicle in front is driving uphill or downhill
- The pedestrian or cyclist is not fully detected, for example, if the pedestrian is leaning over or is not fully walking upright
- The pedestrian or cyclist is wearing clothing or equipment that makes it difficult to detect



The illustration above shows the image the front view camera and front radar are capable of detecting as a vehicle, pedestrian and cyclist.

- The pedestrian or cyclist in front is moving very quickly
- The pedestrian or cyclist in front is short or is posing a low posture
- The pedestrian or cyclist in front has impaired mobility

- The pedestrian or cyclist in front is moving intersected with the driving direction
- There is a group of pedestrians, cyclists or a large crowd in front
- The pedestrian or cyclist is wearing clothing that easily blends into the background, making it difficult to detect
- The pedestrian or cyclist is difficult to distinguish from the similarly shaped structure in the surroundings
- You are driving by a pedestrian, cyclist, traffic signs, structures, etc., near the intersection
- Driving in a parking lot
- Driving through a tollgate, construction area, unpaved road, partial paved road, uneven road, speed bumps, etc.
- Driving on an incline road, curved road, etc.
- Driving through a roadside with trees or streetlights
- The adverse road conditions cause excessive vehicle vibrations while driving
- Your vehicle height is low or high due to heavy loads, abnormal tire pressure, etc.
- Driving through a narrow road where trees or grass are overgrown
- There is interference by electromagnetic waves, such as driving in an area with strong radio waves or electrical noise

Junction Crossing, Lane-Change Oncoming, Lane-Change Side, Evasive Steering Assist function

- The temperature around the front corner radar or rear corner radar is high or low
- A trailer or carrier is installed around the rear corner radar
- The front corner radar or rear corner radar is covered with snow, rain, dirt, etc.
- The bumper around the front corner radar or rear corner radar is covered with objects, such as a bumper sticker, bumper guard, bike rack, etc.
- The bumper around the front corner radar or rear corner radar is impacted, damaged or the radar is out of position
- The front corner radar or rear corner radar is blocked by other vehicles, walls or pillars
- Driving on a highway (or motorway) ramp
- Driving on a road where the guardrail or wall is in double structure
- The other vehicle or powered two-wheeler drives very close behind your vehicle, or the other vehicle or powered two-wheeler passes by your vehicle in close proximity
- The speed of the other vehicle or powered two-wheeler is very fast that it passes by your vehicle in a short time
- Your vehicle passes by the other vehicle

- Your vehicle has started at the same time as the vehicle or powered two-wheeler next to you and has accelerated
- The vehicle or powered two-wheeler in the next lane moves two lanes away from you, or when the vehicle two lanes away moves to the next lane from you
- A motorcycle or bicycle is detected
- A vehicle such as a flat trailer is detected
- A big vehicle such as a bus or truck is detected
- A small moving obstacle such as a pedestrian, animal, shopping cart or a baby stroller is detected
- A vehicle with low height such as a sports car is detected
- The lane is difficult to see due to foreign material, such as rain, snow, dust, sand, oil and water puddles
- The color of the lane marking is not distinguishable from the road
- There are markings on the road near the lane or the markings on the road looks similar to the lane markings
- The shadow is on the lane marking by a median strip, trees, guardrail, noise barriers, etc.
- The lane number increases or decreases, or the lane markings are crossing

- There are more than two lane markings on the road
- The lane markings are complicated or a structure substitutes for the lines, such as a construction area
- There are road markings, such as zigzag lanes, crosswalk markings and road signs
- The lane suddenly disappears, such as at the intersection
- The lane is very wide or narrow
- There is a curb or road edges without a lane
- The vehicle in front is driving with one side on the lane marking
- The distance to the front vehicle is extremely short

Limitations of Evasive Steering Assist

Evasive Steering Assist function may not work properly in the following situations when:

- The pedestrians or cyclists are positioned outside of the operating area.

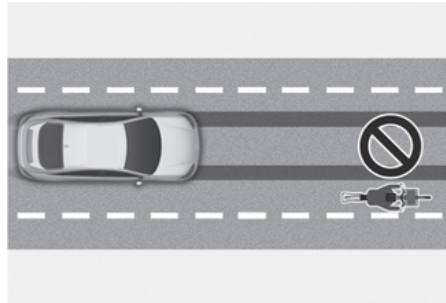

- The pedestrians or cyclists are moving laterally.

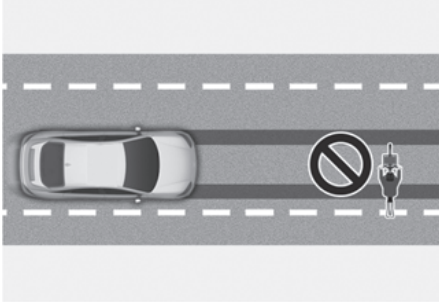

- The pedestrians or cyclists are positioned inside of the operating area, but there is not enough space available for evasive steering.

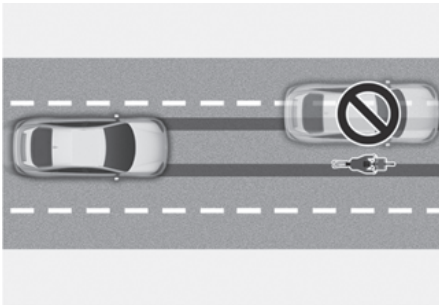

WARNING

- Driving on a curved road

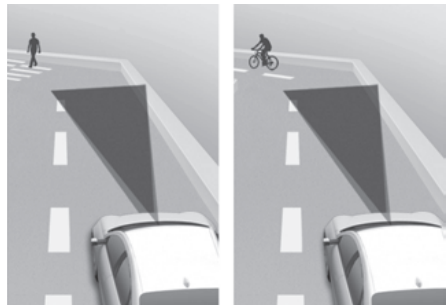
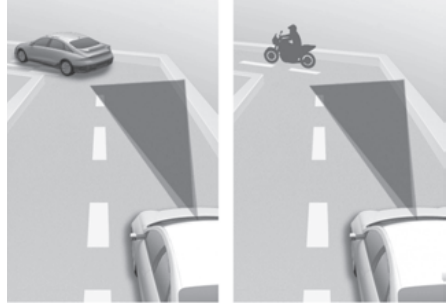

Forward Collision-Avoidance Assist may not detect other vehicles, powered two-wheelers pedestrians or cyclists in front of you when driving on curved roads adversely affecting the performance of the sensors. This may result in no warning, braking assist or steering assist (if equipped) when necessary.

When driving on a curve, you must maintain a safe braking distance, and if necessary, steer the vehicle and depress the brake pedal to reduce your driving speed in order to maintain a safe distance.

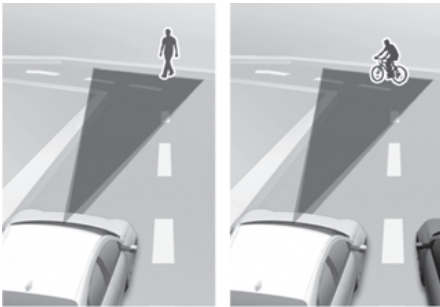
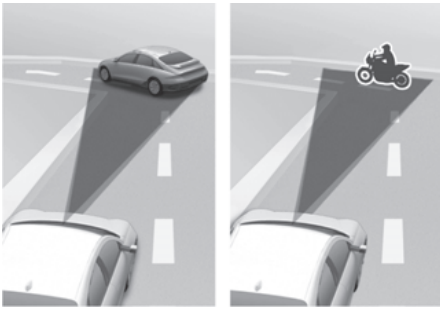

- Driving on an inclined road

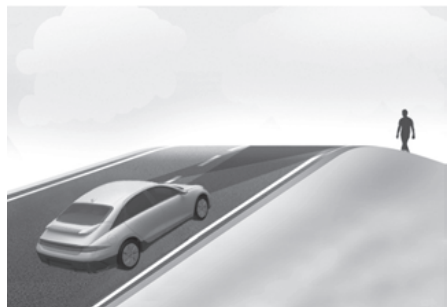
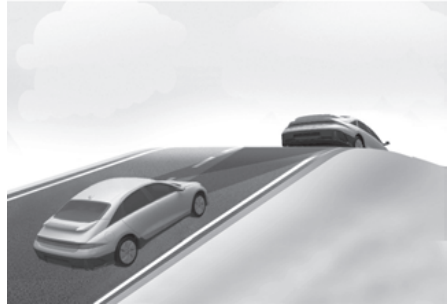

Forward Collision-Avoidance Assist may detect a vehicle, powered two-wheeler pedestrian or cyclist in the next lane or outside the lane when driving on a curved road.

If this occurs, Forward Collision-Avoidance Assist may unnecessarily warn the driver and control the brake or steering wheel (if equipped). Always check the traffic conditions around the vehicle.



Forward Collision-Avoidance Assist may not detect other vehicles, powered two-wheelers, pedestrians or cyclists in front of you while driving uphill or downhill, adversely affecting the performance of the sensors.

This may result in unnecessary warning, braking assist or steering assist (if equipped) or no warning, braking assist or steering assist (if equipped) when necessary.

Also, vehicle speed may rapidly decrease when a vehicle, powered two-wheeler, pedestrian or cyclist ahead is suddenly detected.

Always have your eyes on the road while driving uphill or downhill and if necessary, steer your vehicle and depress the brake pedal to reduce your driving speed in order to maintain a safe distance.

- Changing lanes



[A] Your vehicle
[B] Lane changing vehicle

When a vehicle or powered two-wheeler moves into your lane from an adjacent lane, it cannot be detected by the sensor until it is in the sensor's detection range. Forward Collision-Avoidance Assist may not immediately detect the vehicle or powered two-wheeler when the vehicle or powered two-wheeler changes lanes abruptly. In this case, you must maintain a safe braking distance, and if necessary, steer your vehicle and depress the brake pedal to reduce your driving speed in order to maintain a safe distance.

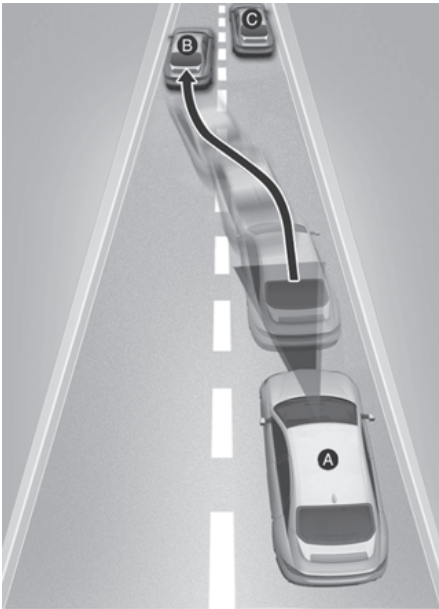

[A] Your vehicle
[B] Lane changing vehicle
[C] Same lane vehicle

When a vehicle in front of you merges out of the lane, Forward Collision-Avoidance Assist may not immediately detect the vehicle or powered two-wheeler that is now in front of you. In this case, you must maintain a safe braking distance, and if necessary, steer your vehicle and depress the brake pedal to reduce your driving speed in order to maintain a safe distance.

- Detecting vehicle

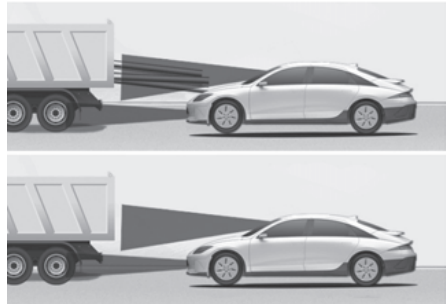

If the vehicle in front of you has cargo that extends rearward from the cab, or when the vehicle in front of you has higher ground clearance, additional special attention is required. Forward Collision-Avoidance Assist may not be able to detect the cargo extending from the vehicle. In these instances, you must maintain a safe braking distance from the rearmost object, and if necessary, steer your vehicle and depress the brake pedal to reduce your driving speed in order to maintain distance.

WARNING

- When you are towing a trailer or another vehicle, turn off Forward Collision-Avoidance Assist for safety reasons.
- Forward Collision-Avoidance Assist may operate if objects that are similar in shape or characteristics to vehicles, powered two-wheelers, pedestrians and cyclists are detected.
- Forward Collision-Avoidance Assist does not operate on bicycles, or smaller wheeled objects, such as luggage bags, shopping carts, or strollers.
- Forward Collision-Avoidance Assist may not operate properly if interfered by strong electromagnetic waves.
- Forward Collision-Avoidance Assist may not operate for 15 seconds after the vehicle is started, or the front view camera is initialized.

Information

For more information on the precautions of the rear corner radar, refer to the "Blind-Spot Collision-Avoidance Assist (BCA)" section in this chapter.

Lane Keeping Assist (LKA)

 if equipped

While driving over a certain speed, Lane Keeping Assist detects lane markings (or road edges) and may warn you if your vehicle leaves the lane without using the turn signal and may assist with steering to prevent your vehicle departing from its travel lane.

Detecting sensor



[A] Front view camera

The front view camera is used as a detecting sensor to detect lane markings (or road edges).

Refer to the picture above for the detailed location of the detecting sensor.

CAUTION

For more information on the precautions of the front view camera, refer to the "Forward Collision Avoidance Assist (FCA)" section in this chapter.

Lane Keeping Assist settings

Lane Safety

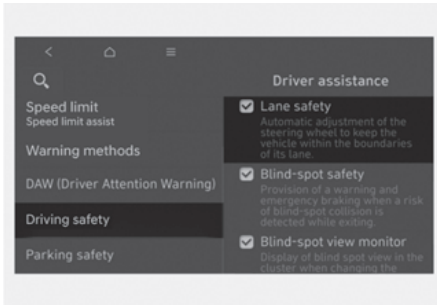

With the vehicle on, select **Setup** (**Settings**) > **Vehicle** > **Driver assistance** > **Driving safety** > **Lane Safety** from the Settings menu to set whether to use each function.

If "Lane Safety" is selected, Lane Keeping Assist will automatically assist the driver's steering when lane departure is detected to help prevent the vehicle from moving out of its lane. If "Lane Safety" is deselected, Lane keeping Assist will turn off and the yellow (🚗) indicator light will turn on the instrument cluster.

WARNING

- Lane Keeping Assist does not control the steering wheel when the vehicle is driven in the middle of the lane.
- The driver should always be aware of the surroundings. If "Lane Safety" is deselected, Lane Keeping assist cannot assist you.

Warning Methods

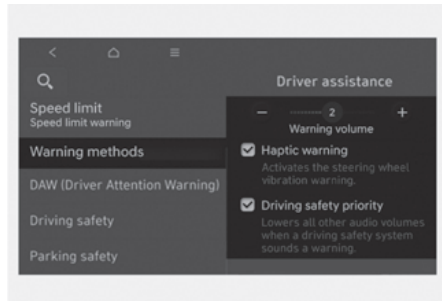

With the vehicle on, go to **Setup** > **Vehicle** > **Driver assistance** > **Warning methods** (**select speaker icon**) from the Settings in the infotainment system to select the following:

- **Warning volume:** The Warning volume can be adjusted.
- **Haptic warning:** The steering wheel vibration can be set.(if equipped)
- **Driving safety priority:** Your vehicle lowers all other audio volumes when the Driver Assistance system warning sounds.

Information

- If you change the Warning methods, Warning methods of other Driver Assistance systems may change.
- If the vehicle is restarted, Warning methods will maintain the last setting.
- There may be no Settings menu depending on the feature applied to your vehicle.

Lane Keeping Assist operation

Turning Lane Keeping Assist On/Off

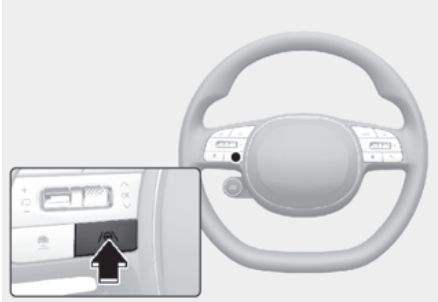

- For Europe
Whenever the vehicle is turned on, Lane Keeping Assist always turn on. The grey (LKA) indicator light illuminates on the cluster. When Lane Keeping Assist is on, press and hold the Lane Driving Assist (LDA) button to turn off the function. When Lane Keeping Assist turn off, the yellow (LKA) indicator light illuminates on the cluster.
- Except Europe
With the vehicle on, press and hold the Lane Driving Assist (LDA) button located on the steering wheel to turn on and off the function. When Lane Keeping Assist is on, the gray or green (LKA) indicator light illuminates on the cluster. When Lane Keeping Assist turn off, the yellow (LKA) indicator light illuminates on the cluster.

i Information

- When Lane Keeping Assist is ready, the grey (LKA) indicator light illuminates on the cluster.
- When Lane Keeping Assist is able to operate, the green (LKA) indicator light illuminates on the cluster.

Warning and control

Lane Keeping Assist will warn and control the vehicle with Lane Departure Warning and Lane Keeping Assist.

Lane Departure Warning

Left



Right

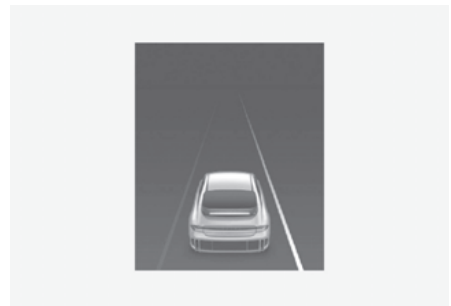

- To warn the driver that the vehicle is departing from the projected lane in front, the green (LKA) indicator light will blink on the instrument cluster, the lane line will blink on the instrument cluster depending on which direction the vehicle is veering, and an audible warning will sound. Also, the steering wheel will vibrate (if equipped).
- Lane Departure Warning will operate when your vehicle speed is between about 60-200 km/h (40-120 mph).

Lane Keeping Assist

- To warn the driver that the vehicle is departing from the projected lane in front, the green (LKA) indicator light will blink on the instrument cluster, and the steering wheel will make adjustments to keep vehicle inside the lane.
- Lane Keeping Assist will operate when your vehicle speed is between about 60-200 km/h (40-120 mph).

Hands-off warning

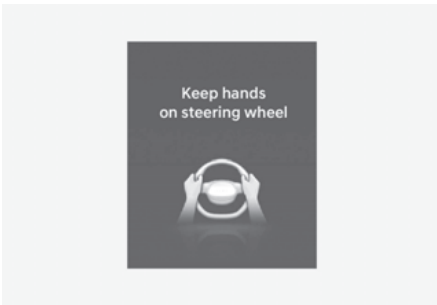

If the driver takes their hands off the steering wheel for several seconds, the **'Keep hands on steering wheel'** warning message will appear on the instrument cluster, and an audible warning will sound in stages.

WARNING

- The steering wheel may not be assisted if the steering wheel is held very tight or the steering wheel is steered over a certain degree.
- Lane Keeping Assist does not operate at all times. It is the responsibility of the driver to safely steer the vehicle and to maintain the vehicle in its lane.
- The hands-off warning message may appear late depending on road conditions. Always have your hands on the steering wheel while driving.
- If the steering wheel is held very lightly, the hands-off warning message may appear because Lane Keeping Assist may not recognize that the driver has their hands on the steering wheel.
- If you attach objects to the steering wheel, the hands-off warning may not work properly.

Information

- For more information on instrument cluster settings, refer to the "Cluster display control" section in chapter 4.
- When lane markings (or road edges) are detected, the lane lines on the instrument cluster will change from grey to white.

Lane undetected



Lane detected

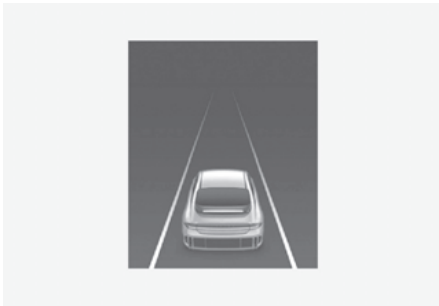

Lane Keeping Assist malfunction and limitations

Lane Keeping Assist malfunction

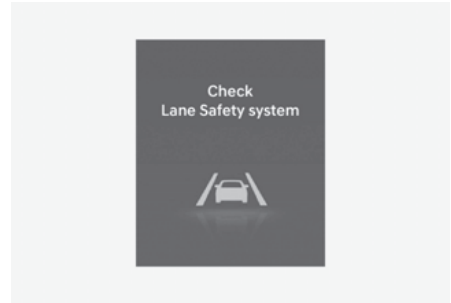

When Lane Keeping Assist is not working properly, the **'Check Lane Safety system'** warning message will appear and the yellow (🚗) indicator light will illuminate on the instrument cluster. If this occurs, we recommend that you have the vehicle inspected by an authorized HYUNDAI dealer.

- The images and colors in the instrument cluster may differ depending on the instrument cluster type or theme selected from the instrument cluster.
- Even though the steering is assisted by Lane Keeping Assist, the driver may control the steering wheel.
- The steering wheel may feel heavier or lighter when the steering wheel is assisted by Lane Keeping Assist than when it is not.

Lane Keeping Assist disabled

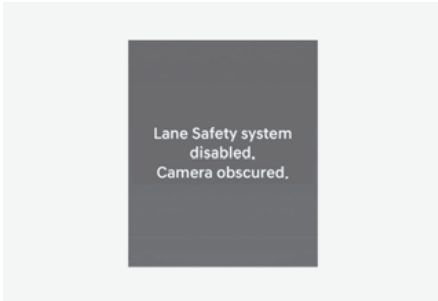

When the front windshield where the front view camera is located, or sensor is covered with foreign material, such as snow or rain, it can reduce the detecting performance and temporarily limit or disable Lane Keeping Assist.

If this occurs, the **'Lane Keeping Assist system disabled. Camera obscured'** warning message and master (⚠) light or Lane Keeping Assist warning light (🚧) will appear on the instrument cluster.

Lane Keeping Assist will operate properly when snow, rain or foreign material is removed.

If Lane Keeping Assist does not operate properly after it is removed, we recommend that you have the vehicle inspected by an authorized HYUNDAI dealer.

WARNING

- Even though the warning message does not appear on the instrument cluster, Lane Keeping Assist may not properly operate.
- If the vehicle is turned off and restarted while the camera is blocked or malfunctioned, the condition is maintained. Therefore, Lane Keeping Assist may not operate properly.

Limitations of Lane Keeping Assist

Lane Keeping Assist may not operate properly or may operate unexpectedly under the following circumstances:

- The lane is contaminated or difficult to detect because:
- The lane markings (or road edge) are covered with rain, snow, dirt, oil, etc.
- The color of the lane marking (or road edge) is not distinguishable from the road
- There are markings (or road edges) on the road near the lane or the markings (or road edges) on the road look similar to the lane markings (or road edge)
- The lane marking (or road edge) is indistinct or damaged
- The shadow is on the lane marking (or road edge) by a median strip, trees, guardrail, noise barriers, etc.
- The lane number increases or decreases, or the lane markings (or road edges) are crossing
- There are more than two lane markings (or road edges) on the road
- The lane markings (or road edges) are complicated or a structure substitutes for the lines, such as a construction area
- There are road markings, such as zigzag lanes, crosswalk markings and road signs
- The lane suddenly disappears, such as at the intersection

- The lane (or road width) is very wide or narrow
- There is a road edge without a lane
- There is a boundary structure in the roadway, such as a tollgate, sidewalk, curb, etc.
- The distance to the front vehicle is extremely short or the vehicle in front is covering the lane marking (or road edge)

Information

For more information on the limitations of the front view camera, refer to the "Forward Collision Avoidance Assist (FCA)" section in this chapter.

WARNING

Take the following precautions when using Lane Keeping Assist:

- The driver has the responsibility to safely drive and control the vehicle. Do not solely rely on Lane Keeping Assist and drive dangerously.
 - The operation of Lane Keeping Assist can be cancelled or not work properly depending on road conditions and surroundings. Always be cautious while driving.
 - Refer to the "Limitations of Lane Keeping Assist" section if the lane is not detected properly.
 - When you are towing a trailer or another vehicle, turn off Lane Keeping Assist for safety reasons.
 - If the vehicle is driven at high speed, the steering wheel will not be controlled. The driver must always follow the speed limit when using Lane Keeping Assist.
- If any other system's warning message is displayed or audible warning is generated, Lane Keeping Assist warning message may not be displayed and audible warning may not be generated.
 - You may not hear the warning sound of Lane Keeping Assist if the surrounding is noisy.
 - If you attach objects to the steering wheel, steering may not be assisted properly.
 - Lane Keeping Assist may not operate for 15 seconds after the vehicle is started, or the front view camera is initialized.
 - Lane Keeping Assist will not operate when:
 - The turn signal or hazard warning flasher is turned on.
 - The vehicle is not driven in the center of the lane when Lane Keeping Assist is turned on or right after changing a lane.
 - ESC (Electronic Stability Control) or VSM (Vehicle Stability Management) is activated.
 - The vehicle is driven on a sharp curve.
 - Vehicle speed is below 55 km/h (35 mph) or above 210 km/h (130 mph).
 - The vehicle makes sudden lane changes.
 - The vehicle brakes suddenly.
 - Loading freight exceeding the maximum load or placing freight unevenly may undermine driving safety. This may also prevent Lane Keeping Assist from operating properly.

Blind-Spot Collision-Avoidance Assist (BCA)

 If equipped

Blind-Spot Collision-Avoidance Assist detects approaching vehicles in the driver's blind spot areas and warn you of a possible collision with a warning light and a warning sound. If there is a collision risk when exiting a parallel space, Blind-Spot Collision-Avoidance Assist may assist with braking your vehicle to help avoid a collision.

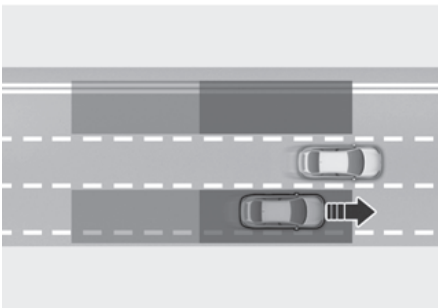

Blind-Spot Collision-Avoidance Assist helps detect and informs the driver that a vehicle is in the blind spot.

CAUTION

The detecting range may vary depending on the speed of your vehicle. Even if there is a vehicle in the blind spot area, Blind-Spot Collision-Avoidance Assist may not warn you when you pass by at high speeds.

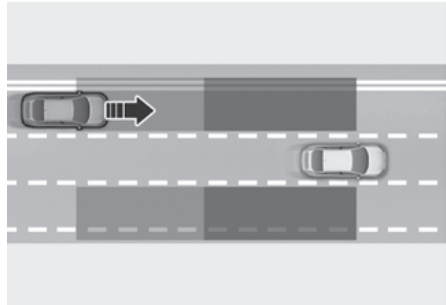

Blind-Spot Collision-Avoidance Assist helps detect and informs the driver that a vehicle is approaching at high speed from the blind spot area.

CAUTION

Warning timing may vary depending on the speed of the vehicle approaching at high speed.

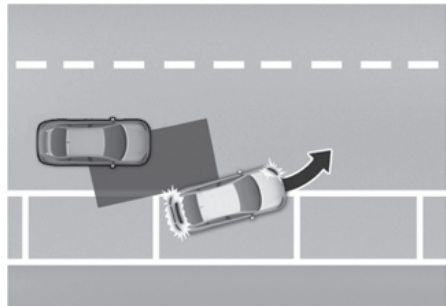

When you are driving forward out of a parking space, if Blind-Spot Collision-Avoidance Assist judges that there is a collision risk with an approaching vehicle in the blind spot, it can help avoid collision by applying the brake.

Detecting sensor

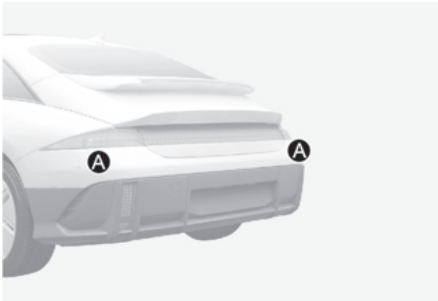

[A] Rear corner radar

Refer to the picture above for the detailed location of the detecting sensors.

CAUTION

Take the following precautions to maintain optimal performance of the detecting sensor:

- Never disassemble the detecting sensor assembly, or cause any damage to it.
- If the rear corner radar or near the radar has been damaged or impacted in any way, even though the warning message does not appear on the instrument cluster, Blind-Spot Collision Avoidance Assist may not operate properly. We recommend that you have the vehicle inspected by an authorized HYUNDAI dealer.
- If the rear corner radars have been replaced or repaired, we recommend that you have the vehicle inspected by an authorized HYUNDAI dealer.

- Use only genuine parts to repair the rear bumper where the rear corner radar is located.
- Rear bumper genuine parts with rear corner radars have proven their performance. Replacing or painting the rear bumper may result in poor performance of Blind-Spot Collision Avoidance Assist. When the parts need to be replaced or modified, make sure to use qualified products.
- Do not apply license plate frame or objects, such as a bumper sticker, film or a bumper guard near the rear corner radar.
- Blind-Spot Collision Avoidance Assist may not work properly if the bumper has been replaced, or the surroundings of the rear corner radar have been damaged or paint has been applied.
- If a trailer, carrier, etc., is installed, it may adversely affect the performance of the rear corner radar or Blind-Spot Collision Avoidance Assist may not operate.

Blind-Spot Collision-Avoidance Assist settings

Blind-Spot Safety

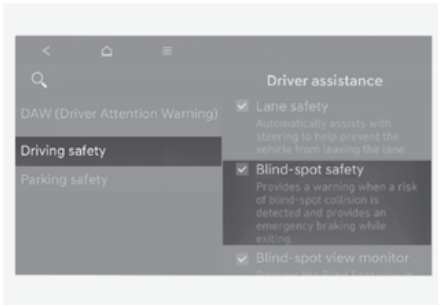

With the vehicle on, select **Setup (Settings) > Vehicle > Driver assistance > Driving safety > Blind-spot safety** from the settings menu to set whether to use each function.

- If "Blind-spot safety" is selected, Blind-Spot Collision Avoidance Assist will warn the driver with a warning message, an audible warning depending on the collision risk levels. Braking assist will be applied for parking exit depending on the collision risk levels.

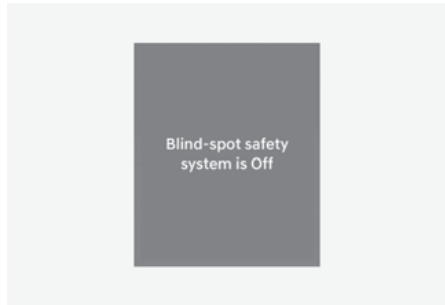

When the vehicle is restarted with Blind-Spot Collision-Avoidance Assist off, the **'Blind-spot safety system is Off'** message will appear on the instrument cluster.

If you select "Blind-spot safety", warning light on the outside rearview mirror will blink for three seconds. In addition, if the vehicle is turned on, when "Blind-spot safety" is selected, the warning light on the outside rearview mirror will blink for three seconds.

WARNING

The driver should always be aware of the surroundings and drive safely. If "Blind-Spot Safety" is deselected, Blind-spot Collision Avoidance Assist cannot assist you.

Information

If the vehicle is restarted, Blind-Spot Collision-Avoidance Assist will maintain the last setting.

Warning Methods

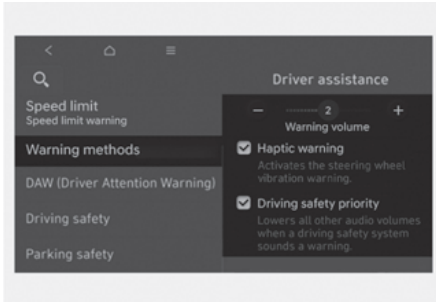

With the vehicle on, go to **Setup > Vehicle > Driver assistance > Warning methods** from the Settings in the infotainment system to select the following:

- **Warning volume:** The Warning volume can be adjusted.
- **Haptic warning:** The steering wheel vibration can be set.(if equipped)
- **Driving safety priority:** Your vehicle lowers all other audio volumes when the Driver Assistance system warning sounds.

i Information

- If you change the Warning methods, Warning methods of other Driver Assistance systems may change.
- If the vehicle is restarted, Warning methods will maintain the last setting.
- There may be no Settings menu depending on the feature applied to your vehicle.

Blind-Spot Collision-Avoidance Assist operation

Driving-Warning

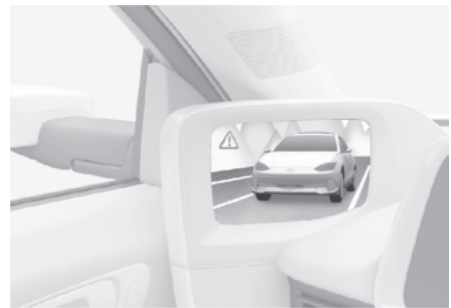
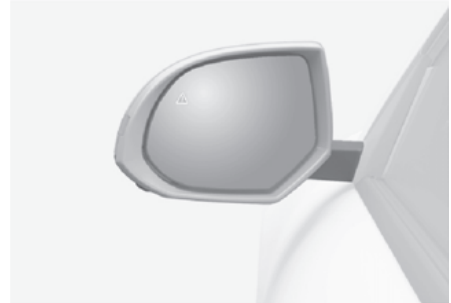

To warn the driver a vehicle is detected, the warning light on the side view mirror illuminates.

Vehicle detection operates under following conditions.

- Your vehicle speed: above 20 km/h (12 mph)
- Vehicle in the blind spot area: above 10 km/h (7 mph)

Collision warning operates when the turn signal is turned on in the direction of the detected vehicle.

- To warn the driver of a collision, the warning light on the side view mirror blinks. At the same time, an audible warning sounds and the steering wheel vibrates.
- When the turn signal is turned off, the collision warning is canceled and Blind-Spot Collision-Avoidance Assist returns to vehicle detection state.

Collision warning operates under following conditions.

- Your vehicle speed: above 40 km/h (25 mph)
- Vehicle in the blind spot area: above 10 km/h (7 mph)



WARNING

- The detecting range of the rear corner radar is determined by a standard road width, therefore, on a narrow road, Blind-Spot Collision-Avoidance Assist may detect other vehicles two lanes over and warn you. In contrast, on a wide road, Blind-Spot Collision-Avoidance Assist may not be able to detect a vehicle driving in the next lane and may not warn you.
 - When the hazard warning flasher is on, the collision warning by the turn signal will not operate.
-

i Information

If the driver's seat is on the left side, the collision warning may occur when you turn left. Maintain a proper distance with the vehicles in the left lane. If the driver's seat is on the right side, the collision warning may occur when you turn right. Maintain a proper distance with the vehicles in the right lane.

The images and colors in the instrument cluster may differ depending on the cluster type or theme selected from the settings menu.

Collision-avoidance assist (while parallel parking exit)

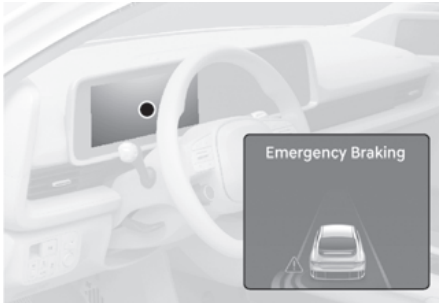

- To warn the driver of a collision, the warning light on the outside rearview mirror will blink and a warning message will appear on the instrument cluster. At the same time, an audible warning will sound, warning light on the head-up display (if equipped) will blink and the steering wheel will vibrate.
- Emergency braking will be assisted to help prevent collision with the vehicle in the blind spot area.
- Blind-Spot Collision-Avoidance Assist will operate when your vehicle speed is below 3 km/h (2 mph) and the speed of the vehicle in the blind spot area is above 5 km/h (3 mph).



- When the vehicle is stopped due to emergency braking, the '**Drive carefully**' warning message will appear on the instrument cluster. For your safety, the driver should depress the brake pedal immediately and check the surroundings.
- Brake control will end after the vehicle is stopped by emergency braking for about 2 seconds.

WARNING

Take the following precautions when using Blind-Spot Collision-Avoidance Assist:

- For your safety, only change the Settings after parking the vehicle at a safe location.
- If any other system's warning message is displayed or audible warning is generated, Blind-Spot Collision-Avoidance Assist's warning message may not be displayed and audible warning may not be generated.

- You may not hear the warning sound of Blind-Spot Collision-Avoidance Assist if the surrounding is noisy.
 - Blind-Spot Collision-Avoidance Assist may not operate if the driver applies the brake pedal to avoid a collision.
 - When Blind-Spot Collision-Avoidance Assist is operating, braking control by the function will automatically cancel when the driver excessively depresses the accelerator pedal or sharply steers the vehicle.
 - During Blind-Spot Collision-Avoidance Assist operation, the vehicle may stop suddenly injuring passengers and shifting loose objects. Always have the seat belt on and keep loose objects secured.
 - Even if there is a problem with Blind-Spot Collision-Avoidance Assist, the vehicle's basic steering and braking performance will operate properly.
 - Blind-Spot Collision-Avoidance Assist does not operate in all situations and cannot avoid all collisions.
 - Blind-Spot Collision-Avoidance Assist may warn the driver late or may not warn the driver depending on the road and driving conditions.
- Driver should maintain control of the vehicle at all times. Do not depend on Blind-Spot Collision-Avoidance Assist. Maintain a safe braking distance, and if necessary, depress the brake pedal to reduce driving speed or to stop the vehicle.
 - Never operate Blind-Spot Collision-Avoidance Assist on people, animal, objects, etc. It may cause serious injury or death.
-

WARNING

The brake control may not operate properly depending on the status of ESC (Electronic Stability Control).

There will only be a warning when:

- The ESC (Electronic Stability Control) warning light is on
 - ESC (Electronic Stability Control) is engaged in a different function
-

Blind-Spot Collision-Avoidance Assist malfunction and limitations

Blind-Spot Collision-Avoidance Assist malfunction

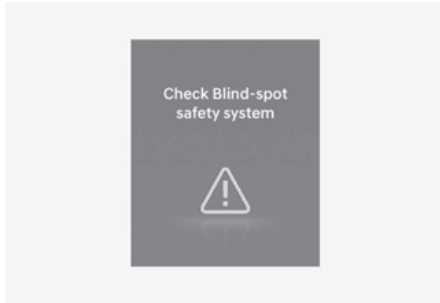

When Blind-Spot Collision Warning is not working properly, the '**Check Blind-spot safety system**' warning message will appear on the instrument cluster for several seconds, and the master (⚠) warning light will illuminate on the instrument cluster. If this occurs, we recommend that you have the vehicle inspected by an authorized HYUNDAI dealer.

Type A

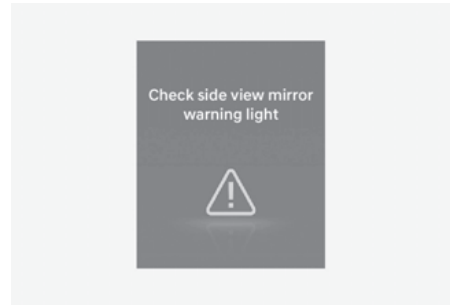

Type B

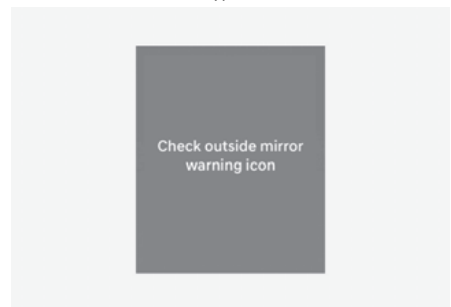

When the outside rearview mirror warning light is not working properly, the '**Check side view mirror warning light**' (or '**Check outside mirror warning icon**') warning message will appear on the instrument cluster for several seconds, and the master (⚠) warning light will illuminate on the instrument cluster. If this occurs, we recommend that you have the vehicle inspected by an authorized HYUNDAI dealer.

Blind-Spot Collision-Avoidance Assist disabled

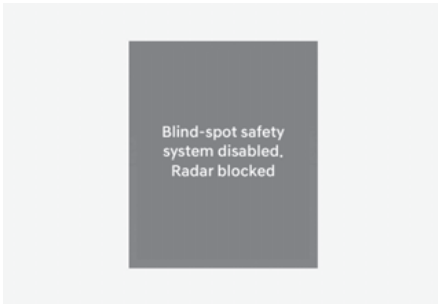

When the rear bumper around the rear corner radar or sensor is covered with foreign material, such as snow or rain, or installing a trailer or carrier, it can reduce the detecting performance and temporarily limit or disable Blind-Spot Collision-Avoidance Assist.

If this occurs, the '**Blind-Spot Safety system(s) disabled. Radar blocked**' warning message will appear on the instrument cluster.

Blind-Spot Collision-Avoidance Assist will operate properly when such foreign material or trailer, etc., is removed, and then the vehicle is restarted.

If Blind-Spot Collision-Avoidance Assist does not operate properly after it is removed, we recommend that you have the vehicle inspected by an authorized HYUNDAI dealer.

WARNING

- Even though the warning message does not appear on the instrument cluster, Blind-Spot Collision-Avoidance Assist may not properly operate.
- Blind-Spot Collision-Avoidance Assist may not properly operate in an area (for example, open terrain) where any objects are not detected right after the vehicle is turned on, or when the detecting sensor is blocked with foreign material right after the vehicle is turned on.

CAUTION

Turn off Blind-Spot Collision-Avoidance Assist to install or remove a trailer, carrier, or another attachment. Turn on Blind-Spot Collision-Avoidance Assist when finished.

Limitations of Blind-Spot Collision-Avoidance Assist

Blind-Spot Collision-Avoidance Assist may not operate properly, or it may operate unexpectedly under the following circumstances:

- There is inclement weather, such as heavy snow, heavy rain, etc.
- The rear corner radar is covered with snow, rain, dirt, etc.

- The temperature around the rear corner radar is high or low
 - Driving on a highway ramp
 - The road pavement (or the peripheral ground) abnormally contains metallic components (for example, possibly due to subway construction)
 - There is a fixed object near the vehicle, such as sound barriers, guardrails, central dividers, entry barriers, street lamps, signs, tunnels, walls, etc. (including double structures)
 - Driving in vast areas where there are few vehicles or structures (for example, desert, meadow, suburb, etc.)
 - Driving through a narrow road where trees or grass are overgrown
 - Driving on a wet road surface, such as a puddle on the road
 - The other vehicle drives very close behind your vehicle, or the other vehicle passes by your vehicle in close proximity
 - The speed of the other vehicle is very fast that it passes by your vehicle in a short time
 - Your vehicle passes by the other vehicle
 - Your vehicle changes lane
 - Your vehicle has started at the same time as the vehicle next to you and has accelerated
 - The vehicle in the next lane moves two lanes away from you, or when the vehicle two lanes away moves to the next lane from you
 - A trailer, carrier or other attachment is installed around the rear corner radar
 - The bumper around the rear corner radar is covered with objects, such as a bumper sticker, bumper guard, bike rack, etc.
 - The bumper around the rear corner radar is impacted, damaged or the radar is out of position
 - Your vehicle height is low or high due to heavy loads, abnormal tire pressure, etc.
- Blind-Spot Collision-Avoidance Assist may not operate properly, or it may operate unexpectedly when the following objects are detected:
- A motorcycle or bicycle is detected
 - A vehicle such as a flat trailer is detected
 - A big vehicle such as a bus or truck is detected
 - A moving obstacle such as a pedestrian, animal, shopping cart or a baby stroller is detected
 - A vehicle with low height such as a sports car is detected

Braking control may not work, driver's attention is required in the following circumstances:

- The vehicle severely vibrates while driving over a bumpy road, uneven road or concrete patch
- Driving on a slippery surface due to snow, water puddle, ice, etc.
- The tire pressure is low or a tire is damaged
- The braking system has been modified
- The vehicle makes abrupt lane changes

i Information

For more information on the limitations of the front view camera, refer to the "Forward Collision Avoidance Assist (FCA)" and "Lane Keeping Assist (LKA)" section in this chapter.

! WARNING

- Driving on a curved road

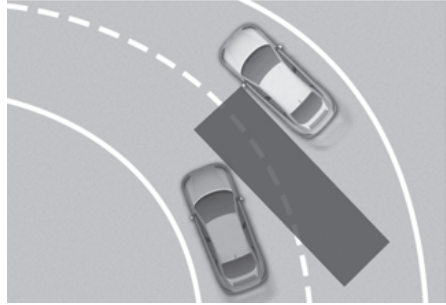

Blind-Spot Collision-Avoidance Assist may not operate properly when driving on a curved road. The function may not detect the vehicle in the next lane.

Always pay attention to road and driving conditions while driving.

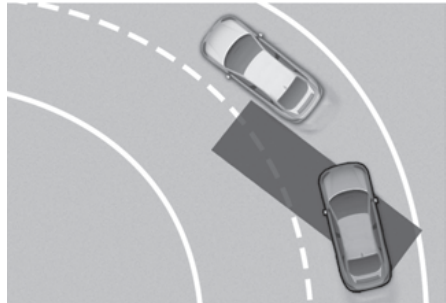

Blind-Spot Collision-Avoidance Assist may not operate properly when driving on a curved road. The function may recognize a vehicle in the same lane.

Always pay attention to road and driving conditions while driving.

- Driving on an inclined road

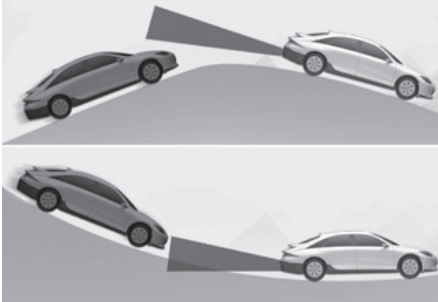

Blind-Spot Collision-Avoidance Assist may not operate properly when driving on a slope. The function may not detect the vehicle in the next lane or may incorrectly detect the ground or structure. Always pay attention to road and driving conditions while driving.

- Driving where the road is merging/dividing

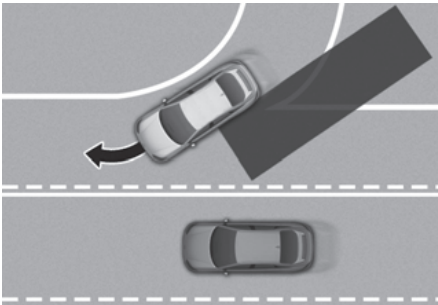

Blind-Spot Collision-Avoidance Assist may not operate properly when driving where the road merges or divides. The function may not detect the vehicle in the next lane.

Always pay attention to road and driving conditions while driving.

- Driving where the heights of the lanes are different

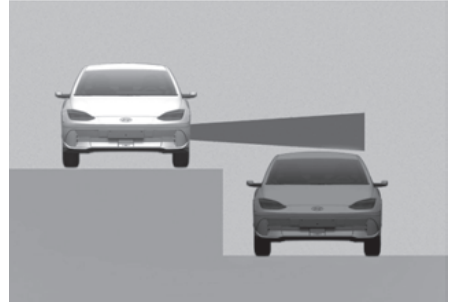

Blind-Spot Collision-Avoidance Assist may not operate properly when driving where the heights of the lanes are different. The function may not detect the vehicle on a road with different lane heights (underpass joining section, grade separated intersections, etc.). Always pay attention to road and driving conditions while driving.

WARNING

- When you are towing a trailer or another vehicle, make sure that you turn off Blind-Spot Collision-Avoidance Assist.
- Blind-Spot Collision-Avoidance Assist may not operate properly if interfered by strong electromagnetic waves.
- Blind-Spot Collision-Avoidance Assist may not operate for 3 seconds after the vehicle is started, or the front view camera or rear corner radars are initialized.

Safe Exit Warning (SEW)

 if equipped

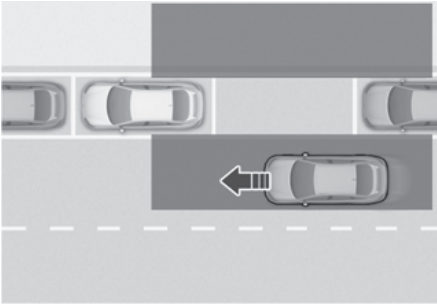

While your vehicle is stopped, and if Safe Exit Warning detects a vehicle approaching the rear corner of your vehicle and a passenger opens a door, Safe Exit Warning may warn you with a warning message and a warning sound to help avoid a collision.

CAUTION

Warning timing may vary depending on the speed of the approaching vehicle.

Detecting sensor

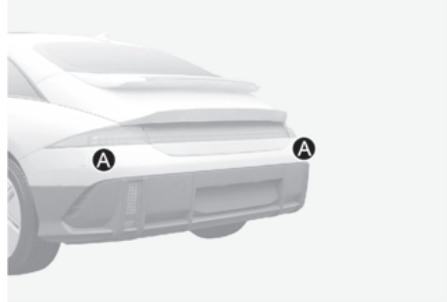

[A] Rear corner radar

Refer to the picture above for the detailed location of the detecting sensors.

CAUTION

For more information on the precautions of the rear corner radars, refer to the "Blind-Spot Collision-Avoidance Assist (BCA)" section in this chapter.

Safe Exit Warning settings

Exit Safety

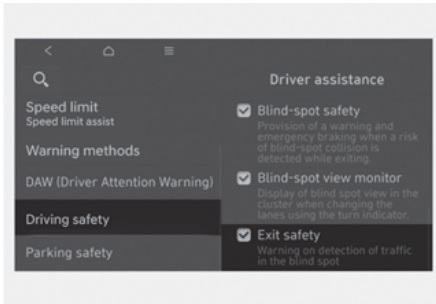

With the vehicle on, select **Setup (Settings) > Vehicle > Driver assistance > Driving safety > Exit safety** from the Settings menu to turn on Safe Exit Warning and deselect to turn off the function.

WARNING

The driver should always be aware of the surroundings. If "Exit Safety" is deselected, Safe Exit Warning cannot assist you.

Information

If the vehicle is restarted, Safe Exit Warning will maintain the last setting.

Warning Methods

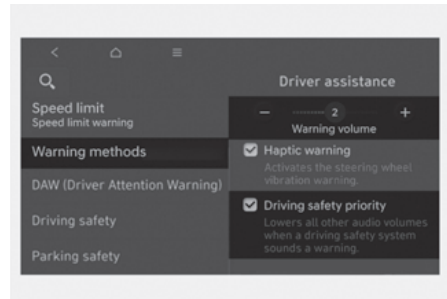

With the vehicle on, go to **Setup > Vehicle > Driver assistance > Warning methods (select speaker icon)** from the Settings in the infotainment system to select the following:

- **Warning volume:** The Warning Volume can be adjusted.
If you turn off the Warning Volume, for your safety, the function may warn you with a low volume.
- **Driving safety priority:** Your vehicle lowers all other audio volumes when the Driver Assistance system warning sounds.

Information

- If you change the Warning methods, Warning methods of other Driver Assistance systems may change.
- If the vehicle is restarted, Warning methods will maintain the last setting.
- There may be no Settings menu depending on the feature applied to your vehicle.

Safe Exit Warning operation

Safe Exit Warning

Safe Exit Warning will warn and control the vehicle with Collision warning when exiting vehicle.

Collision warning when exiting vehicle

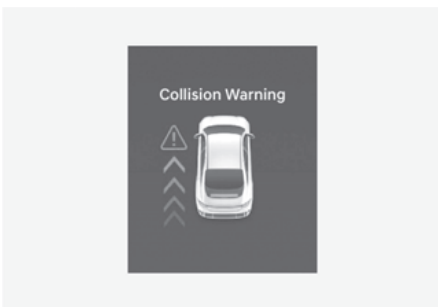
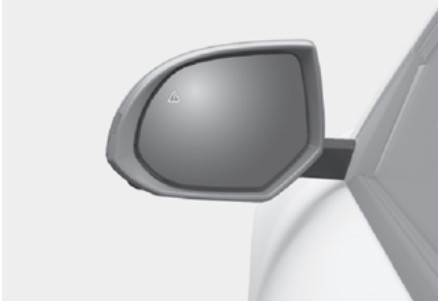

- When an approaching vehicle from the rear is detected at the moment a door is opened, the '**Collision Warning**' warning message will appear on the instrument cluster, and an audible warning will sound.
- Safe Exit Assist will warn the driver when your vehicle speed is below 3 km/h (2 mph), and the speed of the approaching vehicle from the rear is above 6 km/h (4 mph).

WARNING

Take the following precautions when using Safe Exit Warning:

- For your safety, only change the Settings after parking the vehicle at a safe location.
- If any other system's warning message is displayed or audible warning is generated, Safe Exit Warning's warning message may not be displayed and audible warning may not be generated.
- You may not hear the warning sound of Safe Exit Warning if the surroundings are noisy.
- Safe Exit Warning does not operate in all situations and cannot prevent all collisions.
- Safe Exit Warning may warn the driver late or may not warn the driver depending on the road and driving conditions. Always check vehicle surroundings.
- The driver and passengers are responsible for accidents that occur while exiting the vehicle. Always check the surroundings before you exit the vehicle.

i Information

- After the vehicle is turned off, Safe Exit Warning operates about for 3minutes, but turns off immediately if the doors are locked.
- The images and colors in the instrument cluster may differ depending on the cluster type or theme selected from the settings menu.

Safe Exit Warning malfunction and limitations

Safe Exit Warning malfunction

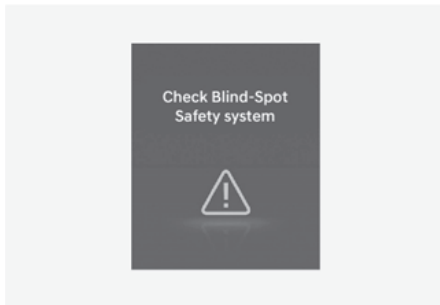

When Safe Exit Warning is not working properly, the '**Check Blind-Spot Safety system(s)**' warning message will appear on the instrument cluster for several seconds, and the master (⚠) warning light will illuminate on the instrument cluster. If this occurs, we recommend that you have the vehicle inspected by an authorized HYUNDAI dealer.

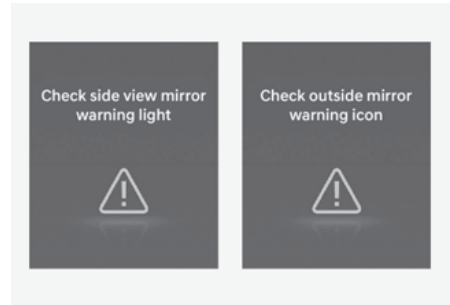

When the outside rearview warning light is not working properly, the '**Check side view mirror warning light**' (or '**Check outside mirror warning icon**') warning message will appear on the instrument cluster for several seconds, and the master (⚠) warning light will illuminate on the instrument cluster. If this occurs, we recommend that you have the vehicle inspected by an authorized HYUNDAI dealer.

Safe Exit Warning disabled

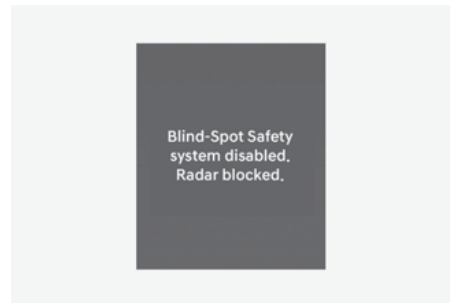

When the rear bumper around the rear corner radar or sensor is covered with foreign material, such as snow or rain, or installing a trailer or carrier, it can reduce the detecting performance and temporarily limit or disable Safe Exit Assist.

If this occurs, the '**Blind-Spot Safety system(s) disabled. Radar blocked**' warning message will appear on the instrument cluster.

Safe Exit Warning will operate properly when such foreign material or trailer, etc., is removed, and then the vehicle is restarted.

If Safe Exit Warning does not operate properly after it is removed, we recommend that you have the vehicle inspected by an authorized HYUNDAI dealer.

 **WARNING**

- Even though the warning message does not appear on the instrument cluster, Safe Exit Warning may not properly operate.
- Safe Exit Warning may not properly operate in an area (for example, open terrain) where any objects are not detected right after the vehicle is turned on, or when the detecting sensor is blocked with foreign material right after the vehicle is turned on.

 **CAUTION**

Turn off Safe Exit Warning to install or remove a trailer, carrier, or another attachment. Turn on Safe Exit Warning when finished.

Limitations of Safe Exit Warning

Safe Exit Warning may not operate properly, or it may operate unexpectedly under the following circumstances:

- Getting out of the vehicle where trees or grass are overgrown
- Getting out of the vehicle where the road is wet
- The approaching vehicle is very fast or very slow

 **Information**

For more information on the limitations of the rear corner radar, refer to the "Blind-Spot Collision-Avoidance Assist (BCA)" section in this chapter.

 **WARNING**

- Safe Exit Warning may not operate properly if interfered by strong electromagnetic waves.
 - Safe Exit Warning may not operate for 3 seconds after the vehicle is started, or the rear corner radars are initialized.
 - If the vehicle is turned off and restarted while the camera is blocked or malfunctioned, the condition is maintained. Therefore, Safe Exit Warning may not operate properly.
-

Manual Speed Limit Assist (MSLA)

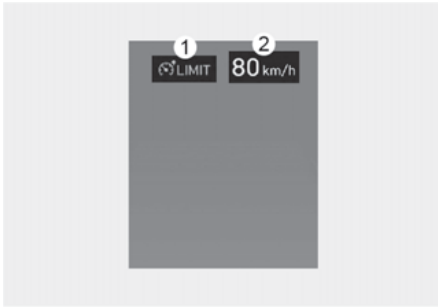



- (1) Speed Limit indicator
- (2) Set speed

You can set the speed limit when you do not want to drive over a specific speed. If you drive over the preset speed limit, Manual Speed Limit Assist will operate (set speed limit will blink and chime will sound) until the vehicle speed returns within the speed limit.

Manual Speed Limit Assist operation

Setting speed limit



1. Press and hold Driving Assist () button at the desired speed. The Speed Limit () indicator will illuminate on the instrument cluster.



2. Push the + switch up or - switch down, and release it at the desired speed.
Push the + switch up or - switch down and hold it. The speed will increase or decrease to the nearest multiple of ten (multiple of five in mph) at first, and then increase or decrease by 10 km/h (5 mph).

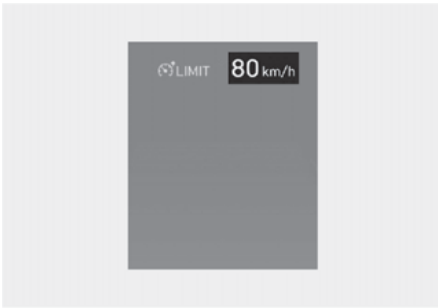

3. The set speed limit will be displayed on the instrument cluster.

If you would like to drive over the preset speed limit, depress the accelerator pedal deeply.



The set speed limit will blink and chime will sound until you return the vehicle speed within the speed limit.

i Information

The set speed may differ depending on the vehicle specifications. You may not increase the set speed above the maximum set speed.

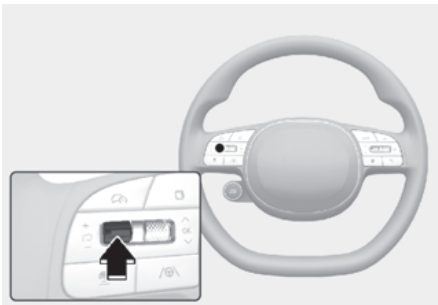
Temporarily pausing Manual Speed Limit Assist



Press the  switch to temporarily pause the set speed limit. The set speed limit will turn off but the Speed Limit () indicator will stay on.

Resuming Manual Speed Limit Assist

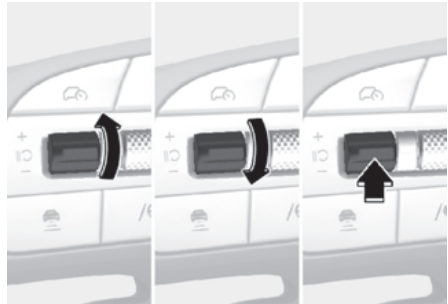



To resume Manual Speed Limit Assist after the function was paused, operate the +, -,  switch.

If you push the + switch up or - switch down, vehicle speed will be set to the current speed on the instrument cluster.

If you press the  switch, vehicle speed will resume to the preset speed.

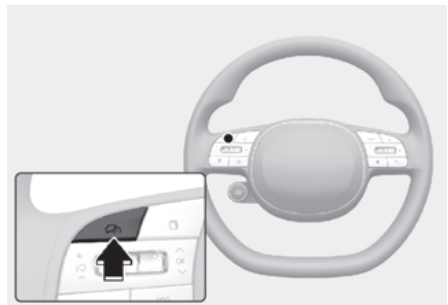
Turning off Manual Speed Limit Assist



Press the Driving Assist () button to turn Manual Speed Limit Assist off. The Speed Limit () indicator will go off.

WARNING

Take the following precautions when using Manual Speed Limit Assist:

- Always set the vehicle speed to the speed limit in your country.
 - Keep Manual Speed Limit Assist off when the function is not in use, to avoid inadvertently setting a speed. Check that the Speed Limit () indicator is off.
 - Manual Speed Limit Assist does not substitute for proper and safe driving. It is the responsibility of the driver to always drive safely and be aware of unexpected and sudden situations. Pay attention to the road conditions at all times.
-

Intelligent Speed Limit Assist (ISLA)

 if equipped

Intelligent Speed Limit Assist uses information from the detected road signs and uses the navigation system data to inform you of the speed limit and to help maintain within the speed limit on the road.

CAUTION

- Intelligent Speed Limit Assist may not operate properly if the function is used in other countries.
 - If a navigation is applied to your vehicle, the navigation needs to be regularly updated for Intelligent Speed Limit Assist to operate properly.
 - The infotainment system may change after software updates. For more information, refer to the manual provided in the infotainment system and the quick reference guide.
-

Detecting sensor



[A] Front view camera

Refer to the picture above for the detailed location of the detecting sensor.

CAUTION

For more information on the precautions of the front view camera, refer to the "Forward Collision Avoidance Assist (FCA)" section in this chapter.

Intelligent Speed Limit Assist settings

Speed Limit

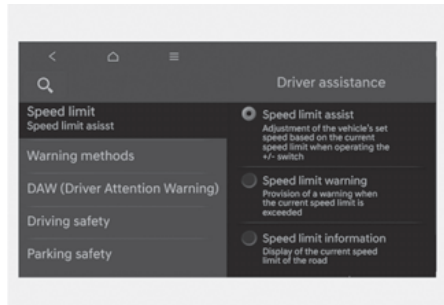

With the vehicle on, select or deselect **Setup (Settings) > Vehicle > Driver assistance > Speed limit** from the Settings menu to set whether to use each function.

- **Select country:** when the navigation system is not available, you can manually select the country to set the speed limit.
- If **'Speed limit assist'** is selected, Intelligent Speed Limit Assist will inform the driver of speed limit and additional road signs. In addition, Intelligent Speed Limit Assist will inform the driver to change set speed of Manual Speed Limit Assist and/or Smart Cruise Control to help the driver stay within the speed limit.

- If '**Speed limit warning**' is selected, Intelligent Speed Limit Assist will inform the driver of speed limit. In addition, Intelligent Speed Limit Assist will warn the driver when the vehicle is driven faster than the speed limit.
- If '**Speed limit information**' is selected, Intelligent Speed Limit Assist will inform the driver of speed limit and additional road signs.
- If '**Off**' is selected, Intelligent Speed Limit Assist will turn off. The  warning light is displayed.

WARNING

For your safety, only change the Settings after parking the vehicle at a safe location.

Warning Methods

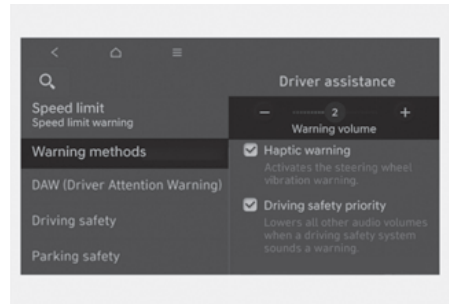

With the vehicle on, go to **Setup > Vehicle > Driver assistance > Warning methods** from the Settings in the infotainment system to select the following:

- **Warning volume:** The Warning volume can be adjusted.
If you turn off the Warning Volume, for your safety, the function may warn you with a low volume.

Information

- If you change the Warning methods, Warning methods of other Driver Assistance systems may change.
- If the vehicle is restarted, Warning methods will maintain the last setting.
- There may be no Settings menu depending on the feature applied to your vehicle.

Intelligent Speed Limit Assist operation

Warning and control

Intelligent Speed Limit Assist will warn and control the vehicle by 'Displaying speed limit', 'Warning overspeed' and 'Changing set speed'.

Displaying speed limit

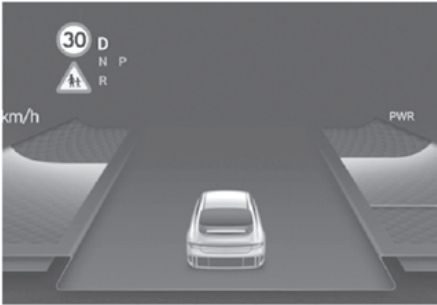

Speed limit information is displayed on the instrument cluster.

i Information

- If speed limit information of the road cannot be recognized, '---' sign will be displayed. Please refer to the "Limitations of Intelligent Speed Limit Assist" section, if the road signs are difficult to recognize.
- Intelligent Speed Limit Assist provides additional road sign information in addition to speed limit. The additional road sign information provided may vary according to your country.

- Supplementary sign displayed under the speed limit or overtaking restriction sign means the conditions under which the signs must be followed. If the supplementary sign is not recognized, it will be displayed as blank.
- The images and colors in the instrument cluster may differ depending on the cluster type or theme selected from the instrument cluster.

Warning overspeed

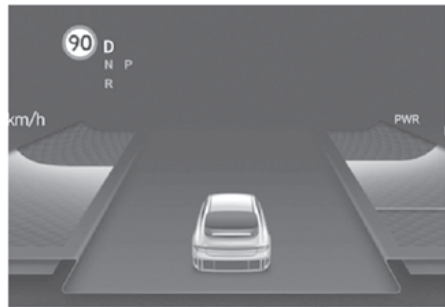

When driving at a speed higher than the displayed speed limit, the red speed limit indicator will blink and warning sounds.

Changing set speed



If the speed limit of the road changes during the operation of Manual Speed Limit Assist or Smart Cruise Control, an arrow in the direction of up or down is displayed to inform the driver that the set speed needs to be changed. At this time, the driver can change the set speed according to the speed limit by using the + or - switch on the steering wheel.

Set Speed Auto Change (Navigation equipped)

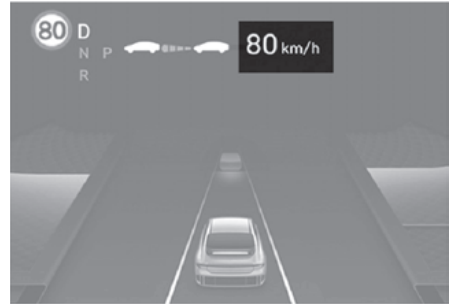

Manual Speed Limit Assist or Smart Cruise Control assists the vehicle to adjust its speed according to the speed limit. When the cruising speed is set as same as the speed limit, the vehicle automatically adjusts its speed if the speed limit changes. The function operates on the road which has a speed limit of 70 km/h (44 mph) or higher. When the function is active, the cruising speed on the instrument cluster appears in green.

WARNING

- Even after changing the set speed according to the speed limit of the road, the vehicle can still be driven over the speed limit. If necessary, depress the brake pedal to reduce your driving speed.
- If the speed limit of the road is under 30 km/h (20 mph), the set speed change function will not work.
- Intelligent Speed Limit Assist operates using the speed units in the instrument cluster set by the driver. If the speed unit is not set to the speed unit used in your country, Intelligent Speed Limit Assist may not operate properly.

i Information

- For more information on Manual Speed Limit Assist operation, refer to the "Manual Speed Limit Assist (MSLA)" section in this chapter.
- For more information on Smart Cruise Control operation, refer to the "Smart Cruise Control (SCC)" section in this chapter.

Intelligent Speed Limit Assist malfunction and limitations

Intelligent Speed Limit Assist malfunction

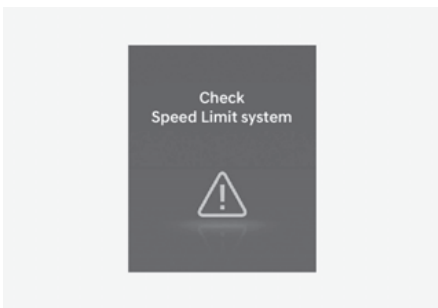

When Intelligent Speed Limit Assist is not working properly, the '**Check Speed Limit system**' warning message will appear on the instrument cluster for several seconds, and the master (⚠) warning light and (⊖) warning light will illuminate on the instrument cluster. If this occurs, we recommend that you have the vehicle inspected by an authorized HYUNDAI dealer.

Intelligent Speed Limit Assist disabled

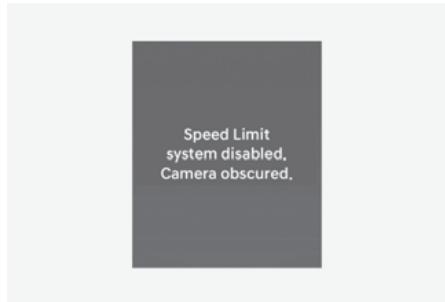

When the front windshield where the front view camera is located is covered with foreign material, such as snow or rain, it can reduce the detecting performance and temporarily limit or disable Intelligent Speed Limit Assist. If this occurs, the '**Speed Limit system disabled. Camera obscured**' warning message and (⊖) warning light will appear on the instrument cluster.

Intelligent Speed Limit Assist will operate properly when snow, rain or foreign material is removed.

If Intelligent Speed Limit Assist does not operate properly after it is removed, we recommend that you have the vehicle inspected by an authorized HYUNDAI dealer.

⚠ WARNING

- Even though the warning message or warning light does not appear on the instrument cluster, Intelligent Speed Limit Assist may not properly operate.
- If the vehicle is turned off and restarted while the camera is blocked or malfunctioned, the condition is maintained. Therefore, Intelligent Speed Limit Assist may not operate properly.

Limitations of Intelligent Speed Limit Assist

Intelligent Speed Limit Assist may not operate properly, or it may operate unexpectedly under the following circumstances:

- The road sign is contaminated or indistinguishable
- The road sign is difficult to see due to bad weather, such as rain, snow, fog, etc.
- The road sign is not clear or damaged
- The road sign is partially obscured by surrounding objects or shadow
- The road signs do not conform to the standard
- The text or picture on the road sign is different from the standard
- The road sign is installed between the main line and the exit road or between diverging roads
- There is no conditional road signs on the road sign located on the exit road
- A sign is attached to another vehicle
- The distance between the vehicle and the road signs is too far
- The vehicle encounters illuminant road signs
- Intelligent Speed Limit Assist incorrectly recognizes numbers or pictures in the street signs or other signs as the speed limit
- A road sign near the road you are driving is detected
- The other traffic sign or signboards are alongside the road sign
- Multiple signs are installed close together
- The minimum speed limit sign is misrecognized
- The minimum speed limit sign is on the road
- The brightness changes suddenly, for example when entering or exiting a tunnel or passing under a bridge
- Headlights are not used or the brightness of the headlights are weak at night or in the tunnel
- Road signs are difficult to recognize due to the reflection of sunlight, street lights, or oncoming vehicles
- The navigation information or GPS information contain errors.
- The driver does not follow the guide of the navigation.
- The driver is driving on a new road that is not in the navigation system yet.
- The field of view of the front view camera is obstructed by sun glare
- Driving on a road that is sharply curved or continuously curved
- Driving through speed bumps, or driving up and down or left to right on steep inclines
- The vehicle is shaking heavily
- Driving on a newly opened road

- The navigation software is being updated while driving
- The navigation is restarted while driving

WARNING

- Intelligent Speed Limit Assist is a supplemental function that helps the driver to comply with the speed limit on the road, and may not display the correct speed limit or control the driving speed properly.
 - Always set the vehicle speed to the speed limit in your area.
 - Intelligent Speed Limit Assist may not operate for 15 seconds after the vehicle is started, or the front camera is initialized.
-

Information

For more information on the limitations of the front view camera, refer to the "Forward Collision Avoidance Assist (FCA)" section in this chapter.

Driver Attention Warning (DAW)

 if equipped

Inattentive Driving Warning

Driver Attention Warning monitors your driving pattern while driving. When the driver's attention level is below a certain level, Driver Attention Warning recommends a break to help with safe driving.

Leading vehicle departure alert function

Leading Vehicle Departure Alert function will inform the driver when a detected vehicle in front departs.

Detecting sensor



[A] Front view camera

The front view camera is used as a detecting sensor to help detect driving patterns and front vehicle departure while vehicle is being driven.

Refer to the picture above for the detailed location of the detecting sensor.

CAUTION

- Always keep the front view camera in good condition to maintain optimal performance of Driver Attention Warning.
- For more information on the precautions of the front view camera, refer to the "Forward Collision Avoidance Assist (FCA)" section in this chapter.

Driver Attention Warning settings

Leading Vehicle Departure Alert

With the vehicle on, select or deselect **Setup (Settings) > Vehicle > Driver assistance > Driver Attention Warning** from the Settings menu to set whether to use the function.

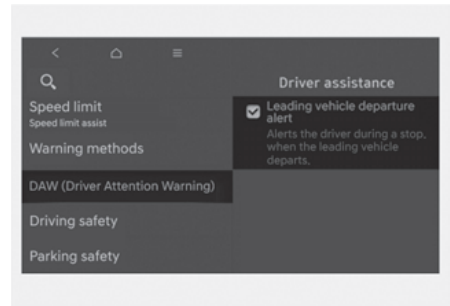

- If 'Leading Vehicle Departure Alert' is selected, the function will inform the driver when a detected vehicle in front departs from a stop.

Driver Attention Warning operation

Inattentive Driving Warning

The basic function of Driver Attention Warning is to warn the driver 'Consider taking a break'.

Taking a break

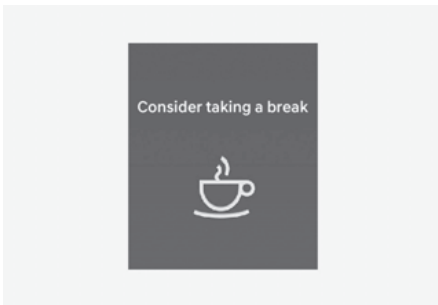

- The '**Consider taking a break**' message and Driver Attention Warning light (☹️) will appear on the instrument cluster and an audible warning will sound to suggest that the driver take a break, when the driver's attention level is below 1.
- Driver Attention Warning will not suggest a break when the total driving time is shorter than 4 minutes or 4 minutes has not passed after the last break was suggested.
- The 'Taking a brake' will operate when your vehicle speed is between about 0-200 km/h (0-120 mph).

⚠️ WARNING

For your safety, change the Settings after parking the vehicle at a safe location.

⚠️ CAUTION

- Driver Attention Warning may suggest a break depending on the driver's driving pattern or habits, even if the driver doesn't feel fatigue.
- Driver Attention Warning is a supplemental function and may not be able to determine whether the driver is inattentive.
- A driver who feels fatigued should take a break at a safe location, even though there is no break suggestion by Driver Attention Warning.

Leading Vehicle Departure Alert function



When a detected vehicle in front departs from a stop, Leading Vehicle Departure Alert will inform the driver by displaying the '**Leading vehicle is driving away**' message on the instrument cluster and an audible warning will sound.

WARNING

- If any other system's warning message is displayed or audible warning is generated, Leading Vehicle Departure Alert's warning message may not be displayed and audible warning may not be generated.
- The driver has the responsibility to safely drive and control the vehicle.

CAUTION

- Leading Vehicle Departure Alert is a supplemental function and may not alert the driver whenever the front vehicle departs from a stop.
- Always check the front of the vehicle and road conditions before departure.



Information

The images and colors in the instrument cluster may differ depending on the cluster type or theme selected from the settings menu.

Driver Attention Warning malfunction and limitations

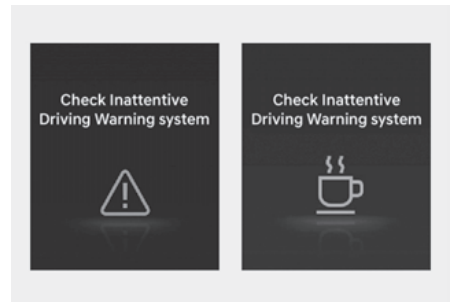
Driver Attention Warning malfunction



When Driver Attention Warning is not working properly, the '**Check Inattentive Driving Warning system**' warning message will appear on the instrument cluster for several seconds, and the master () warning light and Driver Attention Warning light () will illuminate on the instrument cluster. If this occurs, we recommend that you have the vehicle inspected by an authorized HYUNDAI dealer.

Driver Attention Warning disabled

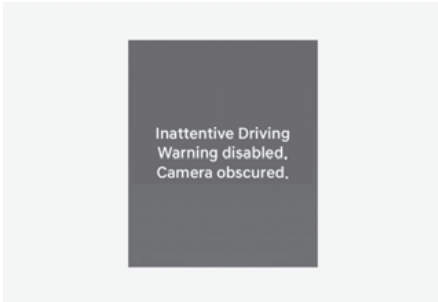

When the front windshield where the front view camera is located is covered with foreign material, such as snow or rain, it can reduce the detecting performance and temporarily limit or disable Driver Attention Warning. If this occurs, the **'Inattentive Driving Warning disabled. Camera obscured'** warning message will appear on the instrument cluster. Driver Attention Warning will operate properly when snow, rain or foreign material is removed. If Driver Attention Warning does not operate properly after it is removed, we recommend that you have the vehicle inspected by an authorized HYUNDAI dealer.

WARNING

- Driver Attention Warning may not properly operate in an area (for example, open terrain) where any objects are not detected right after turning ON the vehicle.
- If the vehicle is turned off and restarted while the camera is blocked or malfunctioned, the condition is maintained. Therefore, Driver Attention Warning may not operate properly.

Limitations of Driver Attention Warning

Driver Attention Warning may not work properly in the following situations:

- The vehicle is driven violently
- The vehicle intentionally crosses over lanes frequently
- The vehicle is controlled by Driver Assistance system, such as Lane Keeping Assist

Leading Vehicle Departure Alert function

- When the vehicle cuts in

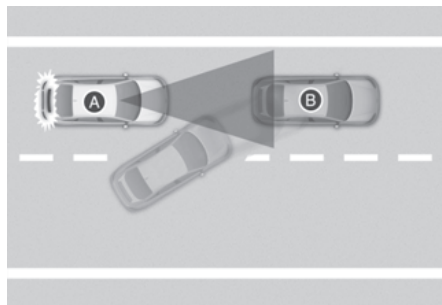
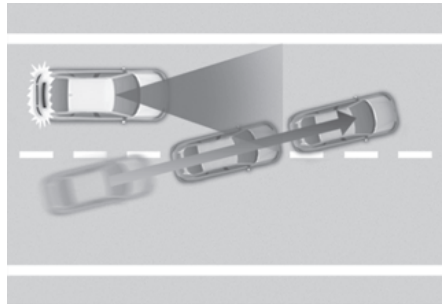

[A] Your vehicle
[B] Front vehicle

If a vehicle cuts in front of your vehicle, Leading Departure Alert may not operate properly.

- When the vehicle ahead sharply steers

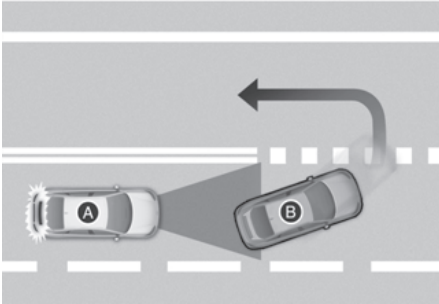

[A] Your vehicle
[B] Front vehicle

If the vehicle in front makes a sharp turn, such as to turn left or right or make a U-turn, etc., Leading Vehicle Departure Alert may not operate properly.

- When the vehicle ahead abruptly departs

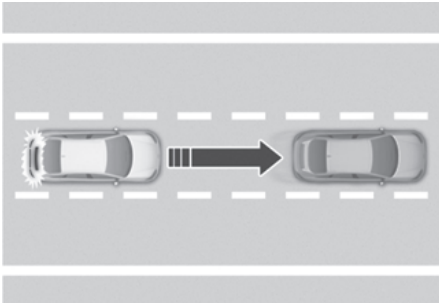

If the vehicle in front abruptly departs, Leading Vehicle Departure Alert may not operate properly.

- When a pedestrian or bicycle is between you and the vehicle ahead



If there is a pedestrian(s) or bicycle(s) in between you and the vehicle in front, Leading Vehicle Departure Alert may not operate properly.

- When in a parking lot

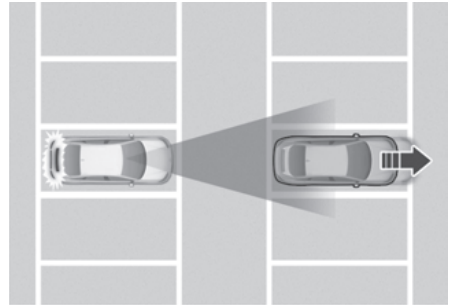

If a vehicle parked in front drives away from you, Leading Vehicle Departure Alert may alert you that the parked vehicle is driving away.

- When driving at a tollgate or intersection, etc.

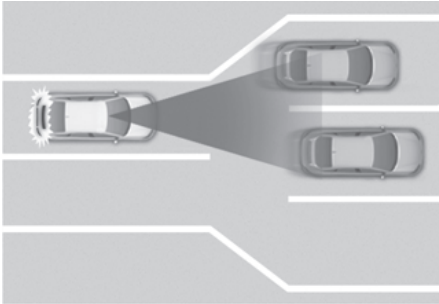

If you pass a tollgate or intersection with lots of vehicles or you drive where lanes are merged or divided frequently, Leading Vehicle Departure Alert may not operate properly.

⚠ WARNING

Driver Attention Warning may not operate for 15 seconds after the vehicle is started, or the front view camera is initialized.

i Information

For more information on the precautions of the front view camera, refer to the "Forward Collision Avoidance Assist (FCA)" section in this chapter.

Blind-Spot View Monitor (BVM)

+ if equipped

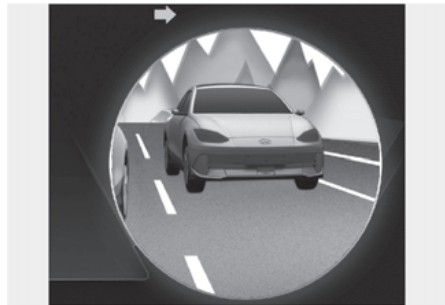

Blind-Spot View Monitor uses the wide-side view cameras to display the rear blind spot areas of your vehicle on the instrument cluster when the turn signal is turned on to help with safe lane changes.

Detecting sensor

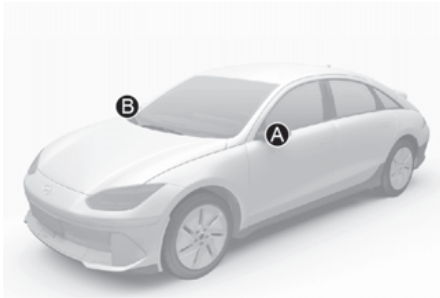

[A] Wide-side view camera (camera located at bottom of the mirror)

[B] Wide-side view camera (camera located at bottom of the mirror)

Refer to the picture above for the detailed location of the detecting sensors.

Blind-Spot View Monitor settings

Setting features

Blind-Spot View

With the vehicle on, select **Setup (Settings) > Vehicle > Driver assistance > Driving safety > Blind-spot view monitor** from the Settings menu to turn on Blind-Spot View Monitor and deselect to turn off the function.

Blind-Spot View Monitor Operation

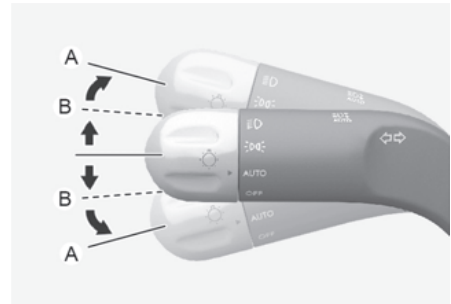

Blind-Spot View Monitor will turn on and off when the turn signal is turned on and off.

Operating conditions

When the left or right side turn signal turns on, the image in that direction is displayed on the instrument cluster.

Off conditions

- When the turn signal turns off, the image on the instrument cluster will turn off.
- When the hazard warning flasher is on, Blind-Spot View Monitor will turn off, regardless of the turn signal status.
- When other important warning is displayed on the instrument cluster, Blind-Spot View Monitor may turn off.

Blind-Spot View Monitor malfunction

When Blind-Spot View Monitor is not working properly, or the cluster display flickers, or the camera image does not display properly, we recommend that you have the vehicle inspected by an authorized HYUNDAI dealer.

WARNING

- The image shown on the instrument cluster may differ from the actual distance of the object. Make sure to directly check the vehicle's surroundings for safety.
- Always keep the camera lens clean. If the lens is covered with foreign material, it may adversely affect camera performance and Blind-Spot View Monitor may not operate properly.

Cruise Control (CC)

 if equipped

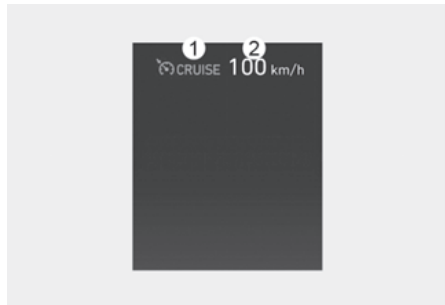

- (1) Cruise indicator
- (2) Set speed



Cruise Control will allow you to drive at speeds above 30 km/h (20 mph) without depressing the accelerator pedal.

Cruise Control operation

Setting speed

1. Accelerate to the desired speed, which must be more than 30 km/h (20 mph).



1. Press the Driving Assist () button at the desired speed. The set speed and Cruise () indicator will illuminate on the instrument cluster.
2. Release the accelerator pedal.
Vehicle speed will maintain the set speed even when the accelerator pedal is not depressed.

i Information

- The vehicle may slightly slow down or speed up while driving uphill or downhill.
- The Driving Assist button symbol may vary depending on your vehicle option.

- Push the + switch up and hold it while monitoring the set speed on the instrument cluster. The set speed will increase to the nearest multiple of ten (multiple of five in mph) at first, and then increase by 10 km/h (5 mph) each time the switch is operated in this manner.

Release the switch when the desired speed is shown and the vehicle will accelerate to that speed.

i Information

The set speed may differ depending on the vehicle specifications. You may not increase the set speed above the maximum set speed.

To increase speed

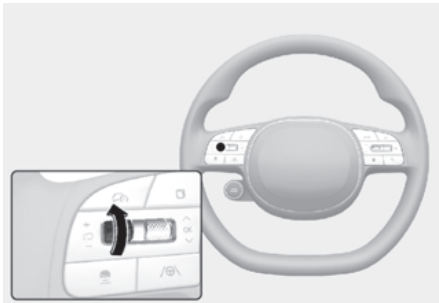

- Push the + switch up and release it immediately. The set speed will increase by 1 km/h (1 mph) each time the switch is operated in this manner.

To decrease speed

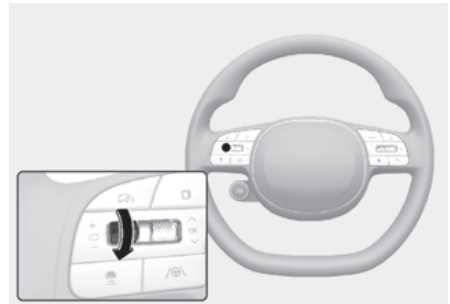

- Push the - switch down and release it immediately. The set speed will decrease by 1 km/h (1 mph) each time the switch is operated in this manner.
- Push the - switch down and hold it while monitoring the set speed on the instrument cluster. The set speed will decrease to the nearest multiple of ten (multiple of five in mph) at first, and then decrease by 10 km/h (5 mph) each time the switch is operated in this manner.

Release the switch at the speed you want to maintain.

Accelerating temporarily

If you want to speed up temporarily when Cruise Control is on, depress the accelerator pedal.

To return to the set speed, take your foot off the accelerator pedal.

If you push the + switch up or - switch down at increased speed, the set speed will be set to the current increased speed.

To temporarily pausing Cruise Control

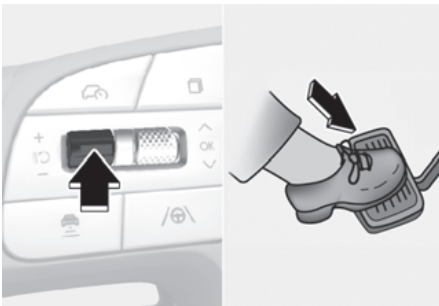

Cruise Control will be paused when:

- Depressing the brake pedal.
- Pushing the || button.
- Shifting the gear to N (Neutral).
- Decreasing vehicle speed to less than about 30 km/h (20 mph).
- Increasing vehicle speed to more than about 190 km/h (120 mph)
- Operating the electronic parking brake system (EPB).
- ESC (Electronic Stability Control) is operating.

The set speed will turn off but the Cruise (CRUISE) indicator will stay on.

NOTICE

If Cruise Control pauses during a situation that is not mentioned, we recommend that you have the vehicle inspected by an authorized HYUNDAI dealer.

Resuming Cruise Control

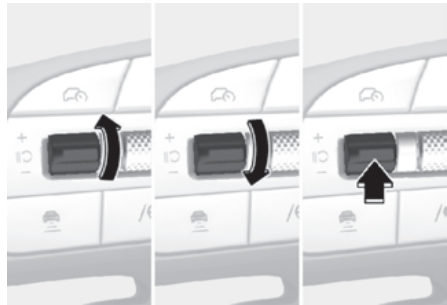

Operate the +, - or || switch.

If you push the + switch up or - switch down, vehicle speed will be set to the current speed on the instrument cluster.

If you press the || switch, vehicle speed will resume to the preset speed.

The vehicle speed must be above 30 km/h (20 mph) for Cruise Control to resume.

WARNING

Check the driving condition before using the || switch. Driving speed may sharply increase or decrease when you press the || switch.

Turning off Cruise Control



Press the Driving Assist (🚗❌) button to turn Cruise Control off. The Cruise (🚗CRUISE) indicator will go off.

Always press the Driving Assist (🚗❌) button to turn Cruise Control off when not in use.

i Information

If your vehicle is equipped with Manual Speed Limit Assist, press and hold the Driving Assist button to turn off Cruise Control. However, Manual Speed Limit Assist will turn on.

⚠️ WARNING

Take the following precautions when using Cruise Control:

- Always set the vehicle speed to the speed limit in your country.
- Keep Cruise Control off when the system is not in use, to avoid inadvertently setting a speed. Check that the Cruise (🚗CRUISE) indicator is off.
- Cruise Control does not substitute for proper and safe driving. It is the responsibility of the driver to always drive safely and should always be aware of unexpected and sudden situations from occurring.
- Always drive cautiously to prevent unexpected and sudden situations from occurring. Pay attention to the road conditions at all times.
- Do not use Cruise Control when it may be unsafe to keep the vehicle at a constant speed:
 - When driving in heavy traffic, or when traffic conditions make it difficult to drive at a constant speed
 - When driving on rainy, icy, or snow-covered roads
 - When driving on hilly or windy roads
 - When driving in windy areas
 - When driving with limited view (possibly due to bad weather, such as fog, snow, rain and sandstorm)
- Do not use Cruise Control when towing a trailer.

Smart Cruise Control (SCC)

 if equipped

Smart Cruise Control detects a vehicle ahead and helps maintain the distance from the vehicle ahead and the set speed.

Overtaking Acceleration Assist

When Smart Cruise Control judges you are attempting to overtake a vehicle in front, Smart Cruise Control help with accelerating.

Based on Driving Style

 if equipped

Smart Cruise Control will operate based on the driver's driving style, such as inter-vehicle distance, acceleration, reaction speed.

Detecting sensor

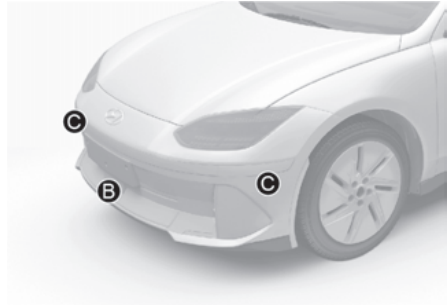

- [A] Front view camera,
- [B] Front radar,
- [C] Front corner radar (if equipped)

The front view camera and front radar are used as a detecting sensor to detect front vehicles.

Refer to the picture above for the detailed location of the detecting sensor.

CAUTION

Always keep the front view camera and front radar in good condition to maintain optimal performance of Smart Cruise Control.

For more information on the precautions of the front view camera and front radar, refer to the "Forward Collision Avoidance Assist (FCA)" section in this chapter.

Smart Cruise Control settings

Smart Cruise Control

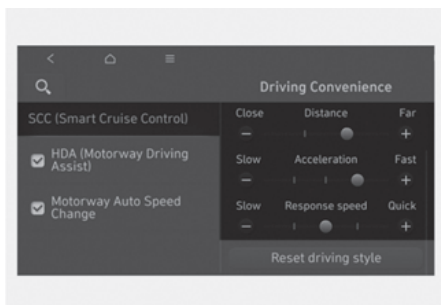

With the vehicle on, select **Setup (Settings) > Vehicle > Driver assistance > Convenience > SCC (Smart Cruise Control) > Based on driving style** from the settings menu to change Distance, Acceleration and Response (Reaction) Speed manually.

Driving Style settings

⁺if equipped

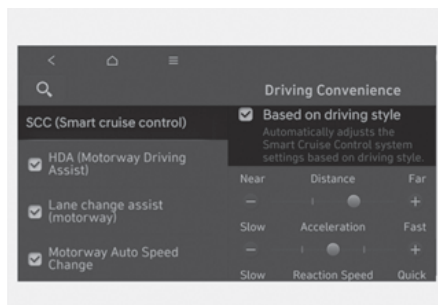

With the vehicle on, select **Setup (Settings) > Vehicle > Driver assistance > Convenience > SCC (Smart Cruise Control) > Based on driving style** from the settings menu to check the driver's driving style, and to change each driving style manually.

i Information

- If the 'Based on driving style' is supported, you can select it from the **Setup (Settings) > Vehicle > Driver assistance > Convenience > SCC (Smart Cruise Control)** menu.
- Based on driving style setting continuously learns when the driver drives the vehicle.
- When Based on driving style is deactivated, the driver's driving style such as vehicle distance, acceleration, response (reaction) speed will maintain in the same stage.
- Even if the steps of the driver's driving style such as vehicle distance, acceleration, response (reaction) speed displayed when the Base on driving style is activated or deactivated are the same, the driving style to be controlled may be differently.

Warning Methods

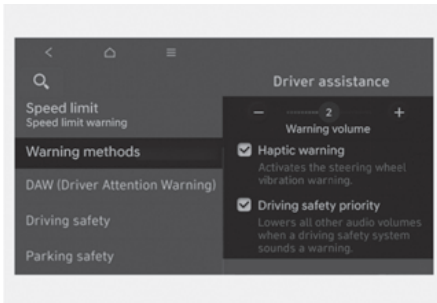

With the vehicle on, go to **Setup > Vehicle > Driver assistance > Warning methods (select speaker icon)** from the Settings in the infotainment system to select the following:

- **Warning volume:** The warning volume can be adjusted.
If you turn off the Warning Volume, for your safety, the function may warn you with a low volume.
- **Haptic warning:** The steering wheel vibration can be set.(if equipped)
- **Driving safety priority:** Your vehicle lowers all other audio volumes when the Driver Assistance system warning sounds.

i Information

- If you change the Warning methods, Warning methods of other Driver Assistance systems may change.
- If the vehicle is restarted, warning methods will maintain the last setting.
- There may be no Settings menu depending on the feature applied to your vehicle.
- The Warning Volume and Haptic Warning cannot be turned off at the same time. When one of the warning is turned off the other is activated.

Smart Cruise Control operation

Operating conditions

Basic function

Smart Cruise Control operates when the following conditions are satisfied.

- The gear is in D (Drive)
- The driver's door is closed
- EPB (Electronic Parking Brake) is not applied
- Your vehicle speed is within the operating speed range
 - 10-180 km/h (5-110 mph): when there is no vehicle in front
 - 0-180 km/h (0-110 mph): when there is a vehicle in front
- ESC (Electronic Stability Control) or ABS (Anti-Lock Braking System) is on

Smart Cruise Control does not operate in the following conditions.

- The driver's door is opened
- Vehicle RPM is high
- EPB (Electronic Parking Brake) is applied
- ESC (Electronic Stability Control) or ABS (Anti-Lock Braking System) is controlling the vehicle
- Forward Collision-Avoidance Assist brake control is operating
- Remote Smart Parking Assist brake control is operating (if equipped)

i Information

When stopped behind another vehicle, the driver can turn on Smart Cruise Control while the brake pedal is depressed.

Operating conditions for Acceleration Assist

Overtaking Acceleration Assist operates when the turn signal indicator is turned on to the left (left-hand drive) or turned on to the right (right-hand drive) while Smart Cruise Control is operating, and the following conditions are satisfied:

- Your vehicle speed is above 60 km/h (40 mph)
- A vehicle is detected in front of your vehicle

Overtaking Acceleration Assist does not operate in the following conditions.

- The hazard warning flasher is on
- Vehicle speed is reduced to maintain distance with the vehicle in front

WARNING

- When the turn signal indicator is turned on to the left (left-hand drive) or turned on to the right (right-hand drive) while there is a vehicle ahead, the vehicle may accelerate temporarily. Pay attention to the road conditions at all times.
- Regardless of the driving direction in your country, Overtaking Acceleration Assist will operate when the conditions are satisfied. When using the function in countries with different driving direction, always check the road conditions at all times.

Turning on Smart Cruise Control



- Press the Driving Assist button to turn on Smart Cruise Control. The speed will be set to the current speed on the instrument cluster.
- If there is no vehicle in front of you, the set speed will be maintained, but if there is a vehicle in front of you, the speed may decrease to maintain the distance to the vehicle ahead. If the vehicle ahead accelerates, your vehicle will travel at a steady cruising speed after accelerating to the set speed.

Information

If your vehicle speed is between 0-30 km/h (0-20 mph) when you press the Driving Assist button, Smart Cruise Control speed will be set to 30 km/h (20 mph).

Setting vehicle distance

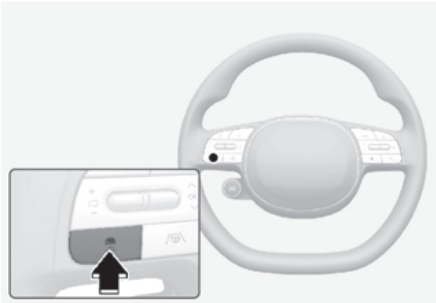

Each time the button is pressed, the headway changes as follows:

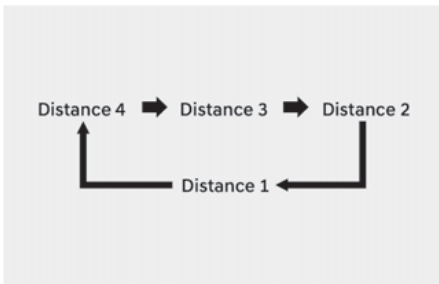

i Information

- If you drive at 90 km/h (56 mph), the distance is maintained as follows:
Distance 4 - about 53 m (172 ft.)
Distance 3 - about 40 m (130 ft.)
Distance 2 - about 30 m (106 ft.)
Distance 1 - about 25 m (82 ft.)
- The distance is set to the last set distance when the vehicle is restarted, or when Smart Cruise Control was temporarily canceled.

Increasing set speed

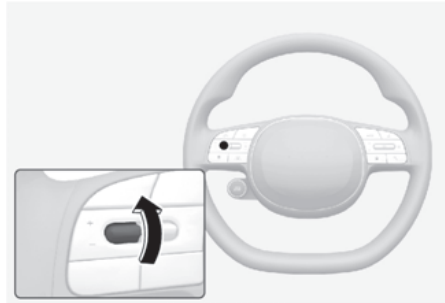

- Push the + switch up and release it immediately. The set speed will increase by 1 km/h (1 mph) each time the switch is operated in this manner.
- Push the + switch up and hold it while monitoring the set speed on the instrument cluster. The set speed will increase 10 km/h (5 mph) each time the switch is operated in this manner. Release the switch when the desired speed is shown, and the vehicle will accelerate to that speed. You can increase the set speed to 180 km/h (110 mph).

! WARNING

Check the driving condition before using the + switch. Driving speed may sharply increase when you push up and hold the + switch.

Decreasing set speed

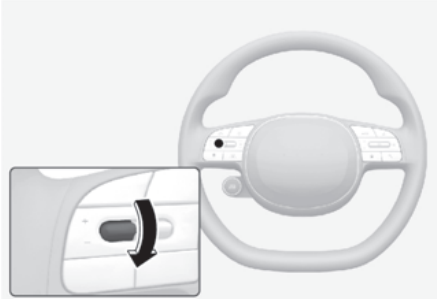

- Push the - switch down and release it immediately. The set speed will decrease by 1 km/h (1 mph) each time the switch is operated in this manner.
- Push the - switch down and hold it while monitoring the set speed on the instrument cluster. The set speed will decrease by 10 km/h (5 mph) each time the switch is operated in this manner. Release the switch at the speed you want to maintain. You can decrease the set speed to 30 km/h (20 mph).

Temporarily cancelling Smart Cruise Control

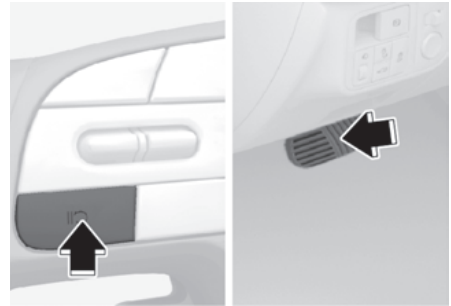

Press the II O switch or depress the brake pedal to temporarily cancel Smart Cruise Control.

Resuming Smart Cruise Control

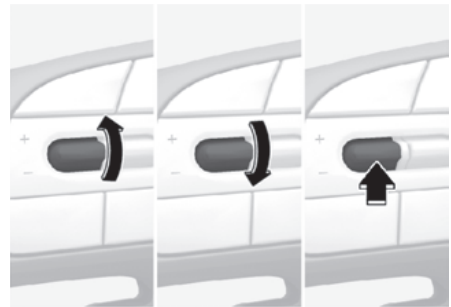



To resume Smart Cruise Control after the function was cancelled, operate the +, - or II O switch.

If you push the + switch up or - switch down, vehicle speed will be set to the current speed on the instrument cluster.

If you press the  switch, vehicle speed will resume to the preset speed.

 **WARNING**

Check the driving condition before using the  switch. Driving speed may sharply increase or decrease when you press the  switch.

Turning off Smart Cruise Control



Press the Driving Assist () button to turn Smart Cruise Control off.

 **Information**

If your vehicle is equipped with Manual Speed Limit Assist, press and hold the Driving Assist () button to turn off Smart Cruise Control. However Manual Speed Limit Assist will turn on.

 **WARNING**

Do not use the switches and buttons at the same time. Smart Cruise Control may not operate properly.

Display and Control

Basic function

You can see the status of the Smart Cruise Control operation in the Driving Assist view on the instrument cluster. Refer to the "Cluster display" section in chapter 4. Smart Cruise Control will be displayed as below depending on the status of the function.

Operating



Temporarily cancelled



- When operating
 1. Whether there is a vehicle ahead and the selected distance level
 2. Set speed
 3. Whether there is a vehicle ahead and the target vehicle distance

- When temporarily cancelled
 1. Your vehicle (gray)
 2. Previous set speed (gray)
 3. Your vehicle and distance level (gray) (if equipped)

i Information

- The distance of the front vehicle on the instrument cluster is displayed according to the actual distance between your vehicle and the vehicle ahead.
- The target distance may vary according to the vehicle speed and the set distance level. If the vehicle speed is low, even though the vehicle distance have changed, the change of the target vehicle distance may be small.
- The images and colors in the instrument cluster may differ depending on the cluster type or theme selected from the settings menu.

Accelerating temporarily



If you want to speed up temporarily without altering the set speed while Smart Cruise Control is operating, depress the accelerator pedal. While the accelerator pedal is depressed, the set speed, distance level and target distance will blink on the instrument cluster. However, if the accelerator pedal is depressed insufficiently, the vehicle may decelerate.

! WARNING

Be careful when accelerating temporarily, because the speed and distance is not controlled automatically even if there is a vehicle in front of you.

Based on Driving Style operation



When Based on driving style is operating, the vehicle distance level and target distance will be displayed white based on the driving style.

Temporarily cancelling Smart Cruise Control

Type A

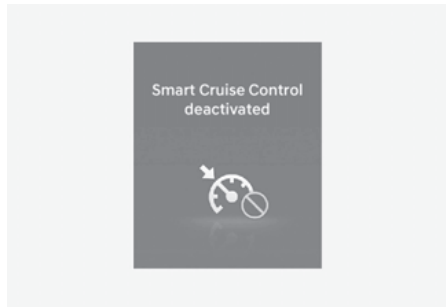

Type B

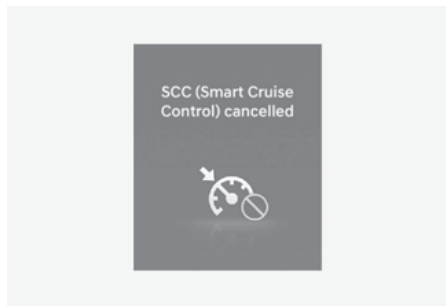

- The vehicle speed is above 190 km/h (120 mph)
- The vehicle is stopped for a certain period of time
- The accelerator pedal is continuously depressed for a certain period of time
- The conditions for the Smart Cruise Control to operate is not satisfied

If Smart Cruise Control is temporarily cancelled automatically, the **'Smart Cruise Control'** deactivated (or **'SCC (Smart Cruise Control) Cancelled'**) warning message will appear on the instrument cluster, and an audible warning will sound to warn the driver.

i Information

If Smart Cruise Control is temporarily cancelled while the vehicle is at a standstill with the function activated, EPB (Electronic Parking Brake) maybe applied.

! WARNING

When Smart Cruise Control is temporarily cancelled, distance with the front vehicle will not be maintained. Always have your eyes on the road while driving, and if necessary, depress the brake pedal to reduce your driving speed in order to maintain a safe distance.

Smart Cruise Control conditions not satisfied

Type A

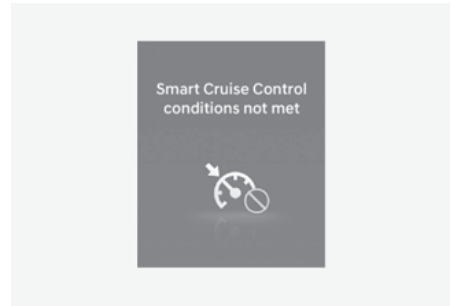

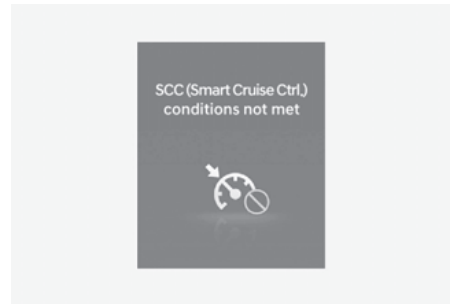

Type B

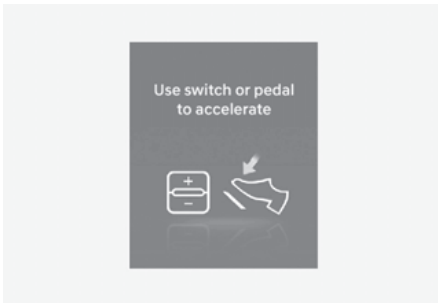

If the Driving Assist button, + switch, - switch or  switch is operated when Smart Cruise Control operating conditions are not satisfied, the **'Smart Cruise Control conditions not met'** (or **'SCC(Smart Cruise Ctrl.) conditions not met'**) will appear on the instrument cluster, and an audible warning will sound.

In traffic situation



In traffic, your vehicle will stop if the vehicle ahead of you stops. Also, if the vehicle ahead of you starts moving, your vehicle will start as well. In addition, after the vehicle has stopped and a certain time have passed, the '**Use switch or pedal to accelerate**' message will appear on the instrument cluster. Depress the accelerator pedal or operate the + switch, - switch or  switch to start driving.

Warning road conditions ahead

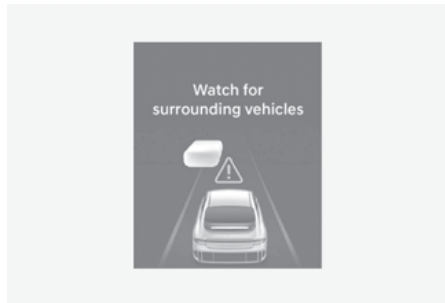

In the following situation, the '**Watch for surrounding vehicles**' warning message will appear on the instrument cluster, and an audible warning will sound to warn the driver of road conditions ahead.

- The vehicle in front disappears when Smart Cruise Control is maintaining the distance with the vehicle ahead while driving below a certain speed.

WARNING

Always pay attention to vehicles or objects that may suddenly appear in front of you, and if necessary, depress the brake pedal to reduce your driving speed in order to maintain a safe distance.

Collision Warning

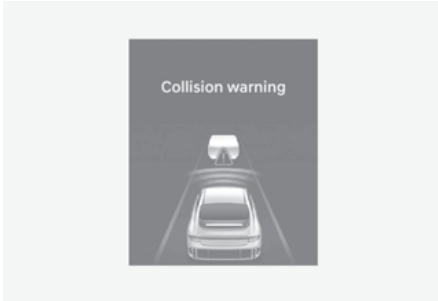

While Smart Cruise Control is operating, when the collision risk with the vehicle ahead is high, the **'Collision Warning'** warning message will appear on the instrument cluster, and an audible warning will sound to warn the driver. Always have your eyes on the road while driving, and if necessary, depress the brake pedal to reduce your driving speed in order to maintain a safe distance.

WARNING

In the following situations, Smart Cruise Control may not warn the driver of a collision.

- The distance from the front vehicle is near, or the vehicle speed of the front vehicle is faster or similar with your vehicle
- The speed of the front vehicle is very slow or is at a standstill
- The accelerator pedal is depressed right after Smart Cruise Control is turned on

WARNING

Take the following precautions when using Smart Cruise Control:

- Smart Cruise Control does not substitute for proper and safe driving. It is the responsibility of the driver to always check the speed and distance to the vehicle ahead.
- Smart Cruise Control may not recognize unexpected and sudden situations or complex driving situations, so always pay attention to driving conditions and control your vehicle speed.
- Keep Smart Cruise Control off when the function is not in use to avoid inadvertently setting a speed.
- Do not open the door or leave the vehicle when Smart Cruise Control is operating, even if the vehicle is stopped.
- Always be aware of the selected speed and headway distance.
- Keep a safe distance according to road conditions and vehicle speed. If the headway distance is too close during high-speed driving, a serious collision may result.
- When maintaining distance with the vehicle ahead, if the front vehicle disappears, Smart Cruise Control may suddenly accelerate to the set speed. Always be aware of unexpected and sudden situations from occurring.
- Vehicle speed may decrease on an upward slope and increase on a downward slope.

- Always be aware of situations such as when a vehicle cuts in suddenly.
 - When you are towing a trailer or another vehicle, turn off Smart Cruise Control for safety reasons.
 - Turn off Smart Cruise Control when your vehicle is being towed.
 - Smart Cruise Control may not operate properly if interfered by strong electromagnetic waves.
 - Smart Cruise Control may not detect an obstacle in front and lead to a collision. Always look ahead cautiously to prevent unexpected and sudden situations from occurring.
 - Vehicles moving in front of you with a frequent lane change may cause a delay in Smart Cruise Control reaction or may cause Smart Cruise Control to react to a vehicle actually in an adjacent lane. Always drive cautiously to prevent unexpected and sudden situations from occurring.
 - Always be aware of the surroundings and drive safely, even though a warning message does not appear or an audible warning does not sound.
 - If any other system's warning message is displayed or warning sound is generated, Smart Cruise Control warning message may not be displayed and warning sound may not be generated.
 - You may not hear the warning sound of Forward Collision-Avoidance Assist if the surrounding is noisy.
 - The vehicle manufacturer is not responsible for any traffic violation or accidents caused by the driver.
 - Always set the vehicle speed under the speed limit in your area.
 - Vehicle distance, acceleration and reaction speed may change if the driver's driving style changes.
-

CAUTION

- The vehicle must be driven sufficiently to reflect the actual driving style of the driver, such as inter-vehicle distance, acceleration and reaction speed.
 - Based on Driving style does not reflect whether the driver has changed when determining the driver's driving style.
 - If you are driving in special conditions, such as snow, rain, fog or steep slopes, the vehicle may not be driven according to the driver's driving style.
-

Information

- Smart Cruise Control may not operate for 15 seconds after the vehicle is started or the front view camera or front radar is initialized.
 - You may hear a sound when the brake is controlled by Smart Cruise Control.
 - Based on Driving Style may not reflect the driver's driving style or driving conditions that affects driving safety.
 - Based on Driving Style does not reflect any other driving style other than inter-vehicle distance, acceleration and reaction speed.
-

Smart Cruise Control malfunction and limitations

Smart Cruise Control malfunction

Type A

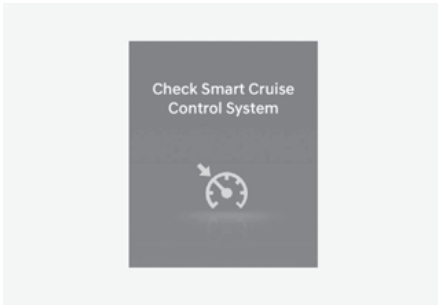

Type B

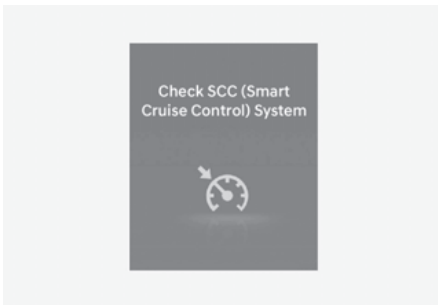

When Smart Cruise Control is not working properly, the '**Check Smart Cruise Control System**' (or '**Check SCC (Smart Cruise Control) system**') warning message will appear, and the (⚠) warning light will illuminate on the instrument cluster. We recommend that you have the vehicle inspected by an authorized HYUNDAI dealer.

Smart Cruise Control disabled

Type A

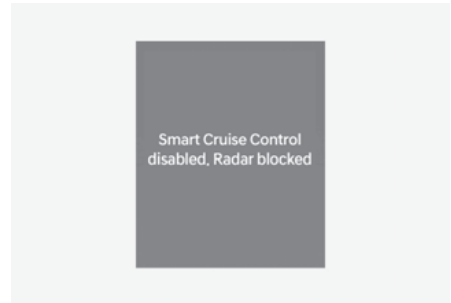

Type B

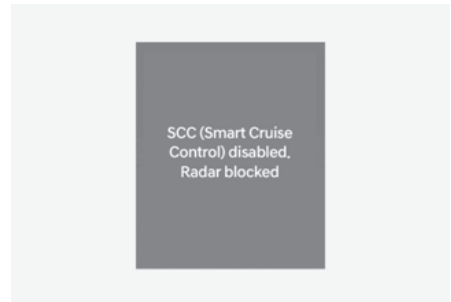

When the front radar cover or sensor is covered with snow, rain, or foreign material, it can reduce the detecting performance and temporarily limit or disable Smart Cruise Control.

If this occurs the '**Smart Cruise Control disabled. Radar blocked**' (or '**SCC (Smart Cruise control) disabled. Radar blocked**') warning message will appear for a certain period of time on the instrument cluster.

Smart Cruise Control will operate properly when snow, rain or foreign material is removed.

WARNING

Even though the warning message does not appear on the instrument cluster, Smart Cruise Control may not properly operate.

CAUTION

Smart Cruise Control may not properly operate in an area (for example, open terrain), where there is nothing to detect after turning ON the vehicle.

Limitations of Smart Cruise Control

Smart Cruise Control may not operate properly, or it may operate unexpectedly under the following circumstances:

- The detecting sensor or the surroundings are contaminated or damaged
- Washer fluid is continuously sprayed, or the wiper is on
- The camera lens is contaminated due to tinted, filmed or coated windshield, damaged glass, or sticky foreign material (sticker, bug, etc.) on the glass
- Moisture is not removed or frozen on the windshield
- The field of view of the front view camera is obstructed by sun glare
- Street light or light from an oncoming vehicle is reflected on the wet road surface, such as a puddle on the road
- The temperature around the front view camera is high or low
- An object is placed on the dashboard
- The surrounding is very bright
- The surrounding is very dark, such as in a tunnel, etc.
- The brightness changes suddenly, for example when entering or exiting a tunnel
- The brightness outside is low, and the headlights are not on or are not bright
- Driving in heavy rain or snow, or thick fog
- Driving through steam, smoke or shadow
- Only part of the vehicle is detected
- The vehicle in front has no tail lights, tail lights are located unusually, etc.
- The brightness outside is low, and the tail lights are not on or are not bright
- The rear of the front vehicle is small or does not look normal (for example, tilted, overturned, etc.)
- The front vehicle's ground clearance is low or high
- A vehicle suddenly cuts in front
- Your vehicle is being towed
- Driving through a tunnel or iron bridge
- Driving near areas containing metal substances, such as a construction zone, railroad, etc.
- An object reflecting off the front radar such as a guardrail, nearby vehicle, etc.
- The bumper around the front radar is impacted, damaged or the front radar is out of position

- The temperature around the front radar is high or low
- Driving in vast areas where there are few vehicles or structures (for example, desert, meadow, suburb, etc.)
- The vehicle in front is made of material that does not reflect on the front radar
- Driving near a highway (or motorway) interchange or tollgate
- Driving on a slippery surface due to snow, water puddle, ice, etc.
- Driving on a curved road
- The vehicle in front is detected late
- The vehicle in front is suddenly blocked by an obstacle
- The vehicle in front suddenly changes lane or suddenly reduces speed
- The vehicle in front is bent out of shape
- The front vehicle's speed is fast or slow
- With a vehicle in front, your vehicle changes lane at low speed
- The vehicle in front is covered with snow
- Unstable driving
- You are on a roundabout and the vehicle in front is not detected
- You are continuously driving in a circle
- Driving in a parking lot
- Driving through a construction area, unpaved road, partial paved road, uneven road, speed bumps, etc.
- Driving on an incline road, curved road, etc.
- Driving through a roadside with trees or streetlights
- The adverse road conditions cause excessive vehicle vibrations while driving
- Your vehicle height is low or high due to heavy loads, abnormal tire pressure, etc.
- Driving through a narrow road where trees or grass are overgrown
- There is interference by electromagnetic waves, such as driving in an area with strong radio waves or electrical noise

- Driving on a curved road



On curves, Smart Cruise Control may not detect a vehicle in the same lane, and may accelerate to the set speed. Also, vehicle speed may rapidly decrease when the vehicle ahead is detected suddenly.

Select the appropriate set speed on curves and apply the brake pedal or accelerator pedal according to the road and driving conditions ahead.

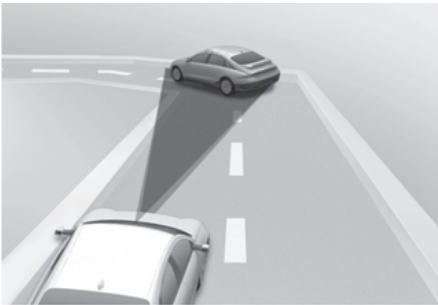

Your vehicle speed can be reduced due to a vehicle in the adjacent lane.

Apply the accelerator pedal and select the appropriate set speed. Check to be sure that the road conditions permit safe operation of the Smart Cruise Control.

- Driving on an inclined road



During uphill or downhill driving, the Smart Cruise Control may not detect a moving vehicle in your lane, and cause your vehicle to accelerate to the set speed. Also, vehicle speed will rapidly decrease when the vehicle ahead is detected suddenly.

Select the appropriate set speed on inclines and apply the brake pedal or accelerator pedal according to the road and driving conditions ahead.

- Changing lanes



[A] Your vehicle

[B] Lane changing vehicle

When a vehicle moves into your lane from an adjacent lane, it cannot be detected by the sensor until it is in the sensor's detection range. Smart Cruise Control may not immediately detect the vehicle when the vehicle changes lanes abruptly. In this case, you must maintain a safe braking distance, and if necessary, depress the brake pedal to reduce your driving speed in order to maintain a safe distance.

- Situations when detecting are limited

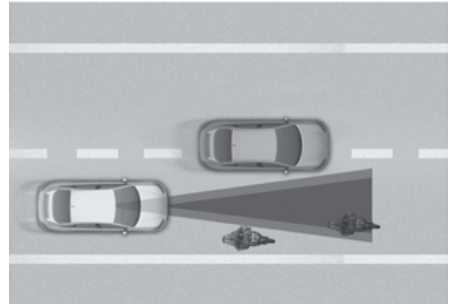

In the following cases, some vehicles, pedestrians or animals in your lane cannot be detected by the sensor:

- Vehicles offset to one side
- Slow-moving vehicles or sudden decelerating vehicles
- Vehicles with higher ground clearance or vehicles carrying loads that stick out of the back of the vehicle
- Vehicles that has the front lifted due to heavy loads
- Vehicles within about 2 m (6 ft.) from your vehicle
- Oncoming vehicles
- Stopped vehicles
- Vehicles with small rear profile, such as trailers
- Narrow vehicles, such as motorcycles or bicycles
 - Special vehicles

- Animals and pedestrians

Adjust your vehicle speed by depressing the brake pedal according to the road and driving conditions ahead.

In the following cases, the vehicle in front cannot be detected by the sensor:

- You are steering your vehicle
- Driving on narrow or sharply curved roads

Adjust your vehicle speed by depressing the brake pedal according to the road and driving conditions ahead.

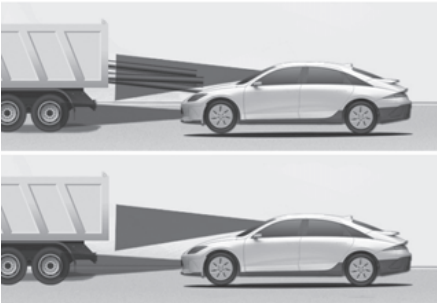

- When a vehicle ahead disappears at an intersection, your vehicle may accelerate.

Always pay attention to road and driving conditions while driving.

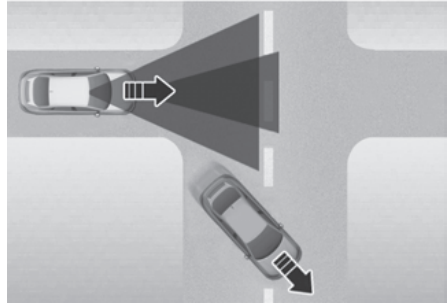

- When a vehicle in front of you merges out of the lane, Smart Cruise Control may not immediately detect the new vehicle that is now in front of you.

Always pay attention to road and driving conditions while driving.

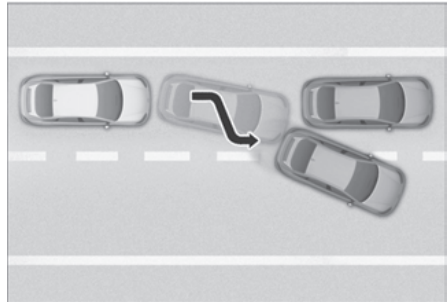

- Always look out for pedestrians when your vehicle is maintaining a distance with the vehicle ahead.

Navigation-Based Smart Cruise Control (NSCC)

 if equipped

Navigation-based Smart Cruise Control helps maintain safe speed depending on the road conditions by using information from the navigation system when driving on highways while Smart Cruise Control is operating.

i Information

- Navigation-based Smart Cruise Control is available only on controlled access road of certain highways.
 - Controlled access road indicates roads with limited entrances and exits that allow uninterrupted high speed traffic flow. Only passenger cars and motorcycles are allowed on controlled access roads.
- Additional highways may be expanded by future navigation updates.

i Information

Navigation-based Smart Cruise Control operates on main roads of highways (or motorways), and does not operate on interchanges or junctions.

Highway Curve Zone Auto Slowdown

If vehicle speed is high, Highway Curve Zone Auto Slowdown function will temporarily decelerate your vehicle or limit acceleration to help you drive safely on a curve based on the curve information from the navigation.

Navigation-based Smart Cruise Control settings

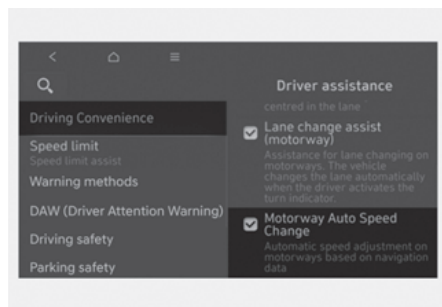

With the vehicle on, select **Setup (Settings) > Vehicle > Driver assistance > Convenience > Highway auto speed change** from the Settings menu to turn on Navigation-based Smart Cruise Control and deselect to turn off the function.

i Information

When there is a problem with Navigation-based Smart Cruise Control, the function cannot be set from the Settings menu.

Navigation-based Smart Cruise Control operation

Operating conditions

Navigation-based Smart Cruise Control is ready to operate if all of the following conditions are satisfied:

- Select '**Highway Auto Speed Change**' from the infotainment system.
- Smart Cruise Control is operating
- Driving on main roads of highways (or motorways)

i Information

For more information on how to operate Smart Cruise Control, refer to the "Smart Cruise Control (SCC)" section in this chapter.

Navigation-based Smart Cruise Control display and control

When Navigation-based Smart Cruise Control operates, it will be displayed on the instrument cluster as follows:



Navigation-based Smart Cruise Control standby

If the operating conditions are satisfied, the green **NAV** indicator light illuminates.

Navigation-based Smart Cruise Control operating

While the speed is being controlled, the green **NAV** indicator light blinks.

Temporarily canceled or interrupted by the driver

If Navigation-based Smart Cruise Control cannot control the vehicle, such as when Smart Cruise Control is temporarily canceled or the navigation system is searching for a route, the gray **NAV** indicator light illuminates.

When the driver depresses the accelerator pedal, the white **NAV** indicator light blinks.

! WARNING



"Drive carefully" warning message will appear in the following circumstances:

- Navigation-based Smart Cruise Control is not able to slow down your vehicle to a safe speed

i Information

The images and colors in the instrument cluster may differ depending on the cluster type or theme selected from the settings menu.

Highway Curve Zone Auto Slowdown

- Depending on the curve ahead on the highway (or motorway), the vehicle will decelerate, and after passing the curve, the vehicle will accelerate to Smart Cruise Control set speed.
- Vehicle deceleration time may differ depending on the vehicle speed and the degree of the curve on the road. The higher the driving speed, deceleration will start faster.

Limitations of Navigation-based Smart Cruise Control

Navigation-based Smart Cruise Control may not operate properly under the following circumstances:

- The navigation is not working properly
- Map information is not transmitted due to infotainment system's abnormal operation
- Speed limit and road information in the navigation is not updated
- The map information and the actual road is different because of real-time GPS data or map information error
- The navigation searches for a route while driving
- GPS signals are blocked in areas such as a tunnel
- A road that divides into two or more roads and joins again
- The driver goes off course the route set in the navigation
- The route to the destination is changed or cancelled by resetting the navigation
- The vehicle enters a service station or rest area
- Android Auto or Car Play is operating
- The navigation cannot detect the current vehicle position (for example, elevated roads including overpass adjacent to general roads or nearby roads exist in a parallel way)
- The navigation is being updated while driving
- The navigation is being restarted while driving
- The speed limit of some sections changes according to the road situations
- Driving on a road under construction
- Driving on a road that is controlled
- There is bad weather, such as heavy rain, heavy snow, etc.

- Driving on a road that is sharply curved

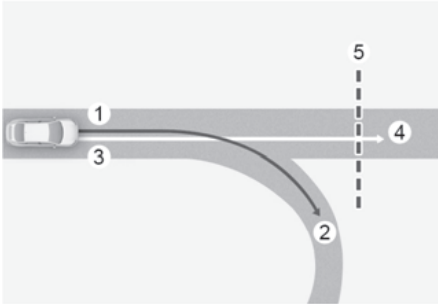

- (1) Set route,
- (2) Branch line,
- (3) Driving route,
- (4) Main road,
- (5) Curved road section

- When there is a difference between the navigation set route (branch line) and the driving route (main road), Highway Curve Zone Auto Slowdown function may not operate until the driving route is recognized as the main road.

- When the vehicle's driving route is recognized as the main road by maintaining the main road instead of the navigation set route, Highway Curve Zone Auto Slowdown function will operate. Depending on the distance to the curve and the current vehicle speed, vehicle deceleration may not be sufficient or may decelerate rapidly.

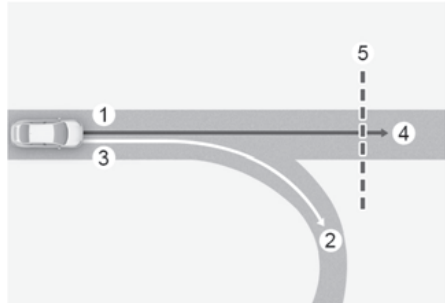

- (1) Set route,
- (2) Branch line,
- (3) Driving route,
- (4) Main road,
- (5) Curved road section

- When there is a difference between the navigation route (main road) and the driving route (branch line), Highway Curve Zone Auto Slowdown function will operate based on the curve information on the main road.

- When it is judged that you are driving out of the route by entering the highway interchange or junction, Highway Curve Zone Auto Slowdown function will not operate.

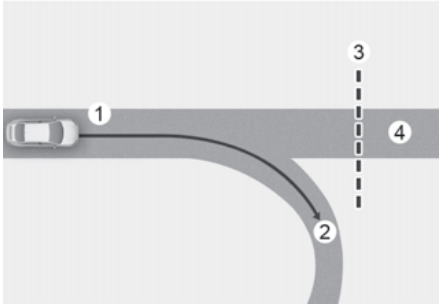

- (1) Driving route,
- (2) Branch line,
- (3) Curved road section,
- (4) Main road,
- If there is no destination set on the navigation, Highway Curve Zone Auto Slowdown function will operate based on the curve information on the main road.
- Even if you depart from the main road, Highway Curve Zone Auto Slowdown function may temporarily operate due to navigation information of the highway curve section.

WARNING

- Navigation-based Smart Cruise Control is not a substitute for safe driving practices, but a convenience function. Always have your eyes on the road, and it is the responsibility of the driver to avoid violating traffic laws.
- The navigation's speed limit information may differ from the actual speed limit information on the road. It is the driver's responsibility to check the speed limit on the actual driving road or lane.
- Navigation-based Smart Cruise Control will automatically be cancelled when you leave the highway (or motorway) main road. Always pay attention to road and driving conditions while driving.
- Navigation-based Smart Cruise Control may not operate due to the existence of leading vehicles and the driving conditions of the vehicle. Always pay attention to road and driving conditions while driving.
- When you are towing a trailer or another vehicle, turn off Navigation-based Smart Cruise Control for safety reasons.
- After you pass through a tollgate on a highway (or motorway), Navigation-based Smart Cruise Control will operate based on the first lane. If you enter one of the other lanes, Navigation-based Smart Cruise Control might not operate properly.

- The vehicle will accelerate if the driver depresses the accelerator pedal while Navigation-based Smart Cruise Control is operating, and the function will not decelerate the vehicle. However, if the accelerator pedal is depressed insufficiently, the vehicle may decelerate.
- If the driver accelerates and releases the accelerator pedal while Navigation-based Smart Cruise Control is operating, the vehicle may not decelerate sufficiently or may rapidly decelerate to a safe speed.
- If the curve is too large or too small, Navigation-based Smart Cruise Control may not operate.

i Information

- A time gap could occur between the navigation's guidance and when Navigation-based Smart Cruise Control operation starts and ends.
- The speed information on the instrument cluster and navigation may differ.
- Even if you are driving at a speed lower than Smart Cruise Control set speed, acceleration may be limited by the curve sections ahead.
- If Navigation-based Smart Cruise Control is operating while leaving the main road to enter an interchange, junction, rest area, etc., the function may operate for a certain period of time.
- Deceleration by Navigation-based Smart Cruise Control may feel it is not sufficient due to road conditions such as uneven road surfaces, narrow lanes, etc.

Lane Following Assist (LFA)

+ If equipped

Lane Following Assist detects lane markings and/or a vehicle ahead on the road, and center your vehicle in the lane.

Detecting sensor



[A] Front view camera

The front view camera is used as a detecting sensor to detect lane markings and front vehicles.

Refer to the picture above for the detailed location of the detecting sensor.

⚠ CAUTION

For more information on the precautions of the front view camera, refer to the "Forward Collision Avoidance Assist (FCA)" section in this chapter.

Lane Following Assist settings

Warning Methods

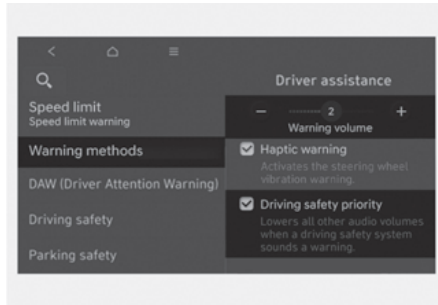

With the vehicle on, go to **Setup > Vehicle > Driver assistance > Warning methods (select speaker icon)** from the Settings in the infotainment system to select the following:

- **Warning volume:** The Warning Volume can be adjusted.

If you turn off the Warning Volume, for your safety, the function may warn you with a low volume.

- **Driving safety priority:** Your vehicle lowers all other audio volumes when the Driver Assistance system warning sounds.

i Information

- If you change the Warning methods, Warning methods of other Driver Assistance systems may change.
- If the vehicle is restarted, Warning methods will maintain the last setting.
- There may be no Settings menu depending on the feature applied to your vehicle.

Lane Following Assist operation

Turning Lane Following Assist On/Off

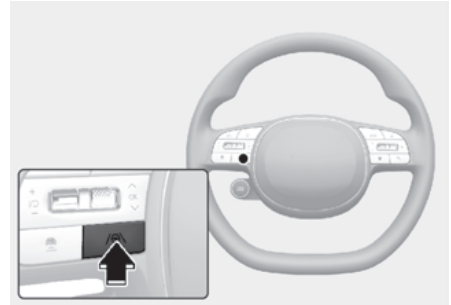

With the vehicle on, shortly press the Lane Driving Assist button located on the steering wheel to turn on Lane Following Assist. The grey or green (🚗) indicator light will illuminate on the instrument cluster.

Press the button again to turn off the function.

Lane Following Assist



If the vehicle ahead and/or both lane markings are detected and your vehicle speed is below 180 km/h (110 mph), the green (➡) indicator light illuminates on the instrument cluster, and Lane Following Assist helps center the vehicle in the lane by assisting the steering wheel.

CAUTION

When the steering wheel is not assisted, the white (➡) indicator light blinks and changes to grey.

Hands-off warning



If the driver takes their hands off the steering wheel for several seconds, the **'Keep hands on steering wheel'** warning message will appear and an audible warning will sound in stages.

First stage: Warning message

Second stage: Warning message (red steering wheel) and audible warning

Type A

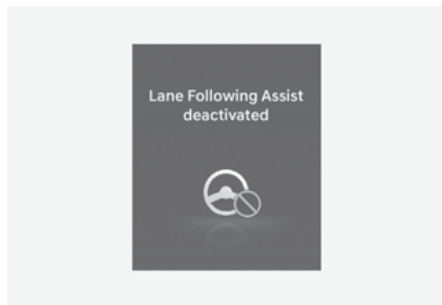

Type B

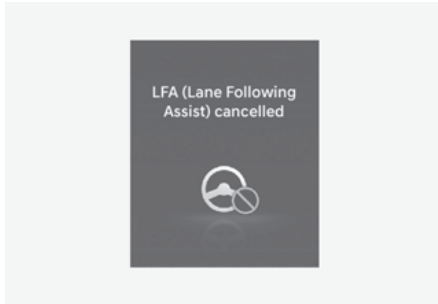

If the driver still does not have their hands on the steering wheel after the hands-off warning, the '**Lane Following Assist deactivated**' (or '**LFA (Lane Following Assist) cancelled**') warning message will appear and Lane Following Assist will be automatically cancelled.

WARNING

- The steering wheel may not be assisted if the steering wheel is held very tight or the steering wheel is steered over a certain degree.
- Lane Following Assist does not operate at all times. It is the responsibility of the driver to safely steer the vehicle and to maintain the vehicle in its lane.
- The hands-off warning message may appear late depending on road conditions. Always have your hands on the steering wheel while driving.
- If the steering wheel is held very lightly the hands-off warning message may appear because Lane Following Assist may not recognize that the driver has their hands on the steering wheel.
- If you attach objects to the steering wheel, the hands-off warning may not work properly.

Information

- For more information on instrument cluster settings, refer to the "Cluster display control" section in chapter 4.
- When both lane markings are detected, the lane lines on the instrument cluster will change from grey to white.

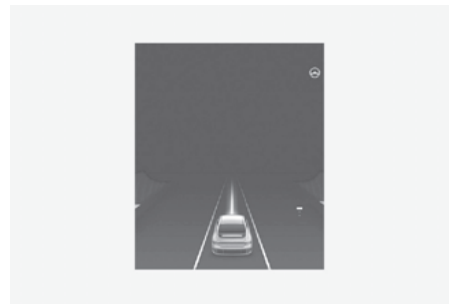

- The images and colors in the instrument cluster may differ depending on the instrument cluster type or theme selected from the settings menu.
- If lane markings are not detected, steering wheel control by Lane Following Assist can be limited depending on whether a vehicle is in front or the driving conditions of the vehicle.

- Even though the steering is assisted by Lane Following Assist, the driver may control the steering wheel.
 - The steering wheel may feel heavier or lighter when the steering wheel is assisted by Lane Following Assist than when it is not.
-

Lane Following Assist Malfunction and Limitations

Lane Following Assist malfunction

Type A

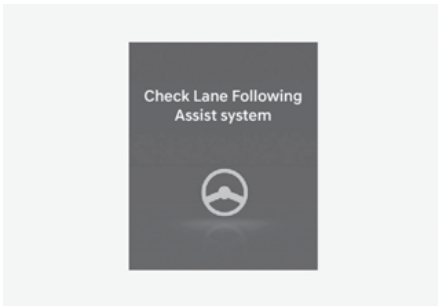

Type B

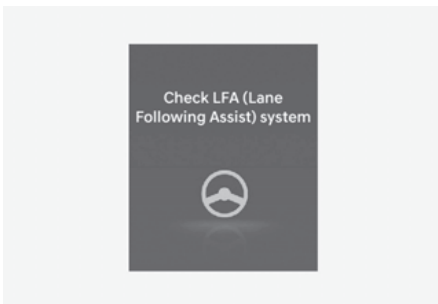

When Lane Following Assist is not working properly, the '**Check Lane Following Assist system**' (or '**Check LFA (Lane Following Assist) system**') warning message will appear on the instrument cluster for several seconds, and the master (⚠) warning light illuminates on the instrument cluster. If this occur, we recommend that you have the vehicle inspected by an authorized HYUNDAI dealer.

Limitations of Lane Following Assist

For more information on Lane Following Assist's limitations, refer to the "Lane Keeping Assist (LKA)" section in this chapter.

i Information

For more information on "Warnings" when using Lane Following Assist, refer to the "Lane Keeping Assist (LKA)" section in this chapter.

! WARNING

Loading freight exceeding the maximum load or placing freight unevenly may undermine driving safety. This may also prevent Lane Following Assist from operating properly.

Highway Driving Assist (HDA)

 if equipped

Basic function

Highway Driving Assist detect lanes and vehicles ahead, and help maintain the distance from the vehicle ahead and the set speed, and center your vehicle in the lane while driving on the highway.

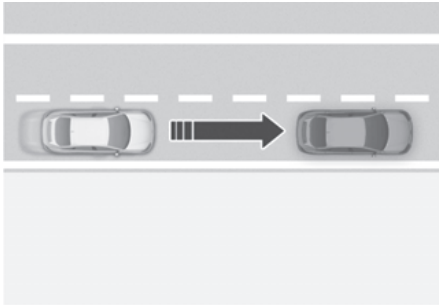

Highway Lane Change Assist (if equipped)

Highway Lane Change Assist function helps change lanes to the direction you operate the turn signal switch if the function judges that lane change is possible.

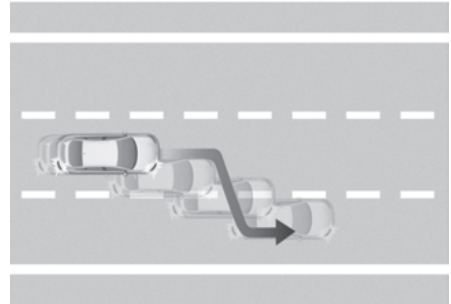

i Information

- Highway Driving Assist is available only on controlled access road of certain highways.
 - Controlled access road indicates roads with limited entrances and exits that allow uninterrupted high speed traffic flow. Only passenger cars and motorcycles are allowed on controlled access roads.
- Additional highways may be expanded by future navigation updates.

i Information

Highway Driving Assist operates on main roads of highways (or motorways), and does not operate on interchanges or junctions.

Detecting sensor

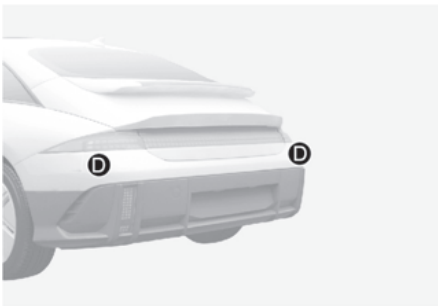
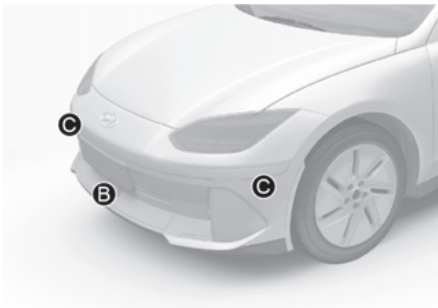

- [A] Front view camera,
- [B] Front radar,
- [C] Front corner radar (if equipped),
- [D] Rear corner radar (if equipped)

Refer to the picture above for the detailed location of the detecting sensors.

CAUTION

For more information on the precautions of the detecting sensors, refer to the "Forward Collision Avoidance Assist (FCA)" section in this chapter.

Highway Driving Assist settings

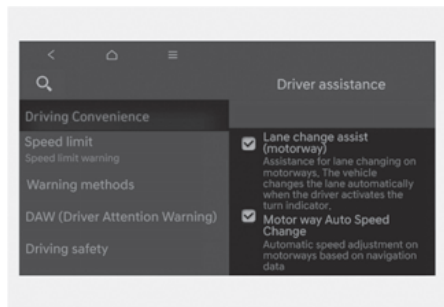

With the vehicle on, select or deselect **Setup (Settings) > Vehicle > Driver assistance > Driving convenience** from the Settings menu to set whether to use each function.

Basic function

If "HDA (Motorway Driving Assist)" is selected, it helps maintain distance from the vehicle ahead, maintain the set speed, and helps center the vehicle in the lane.

Highway Lane Change Assist

+ if equipped

If "Lane change assist (motorway)" is selected, it helps the driver change lanes.

i Information

- When "HDA (Motorway Driving Assist)" is deselected, the setting for "Lane change assist (motorway)" cannot be changed.
- If there is a problem with the functions, the settings cannot be changed. We recommend that the vehicle be inspected by an authorized HYUNDAI dealer.
- If the vehicle is restarted, the functions will maintain the last setting.

! WARNING

For your safety, only change the settings after parking the vehicle at a safe location.

Warning Methods

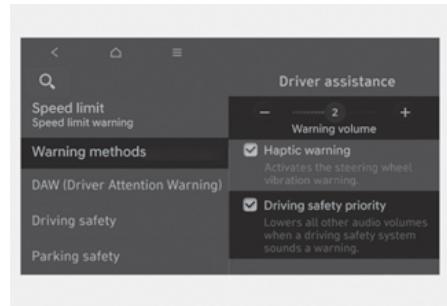

With the vehicle on, go to **Setup > Vehicle > Driver assistance > Warning methods (select speaker icon)** from the Settings in the infotainment system to select the following:

- **Warning volume:** The Warning Volume can be adjusted.
If you turn off the Warning Volume, for your safety, the function may warn you with a low volume.
- **Driving safety priority:** Your vehicle lowers all other audio volumes when the Driver Assistance system warning sounds.

i Information

- If you change the Warning methods, Warning methods of other Driver Assistance systems may change.
- If the vehicle is restarted, Warning methods will maintain the last setting.
- There may be no Settings menu depending on the feature applied to your vehicle.

Highway Driving Assist operation

Basic function

Displaying operating status

You can see the status of the Highway Driving Assist operation in the Driving Assist view on the instrument cluster. Refer to the "View modes" section in chapter 4.

Highway Driving Assist will be displayed as below depending on the status of the function.

Operating state

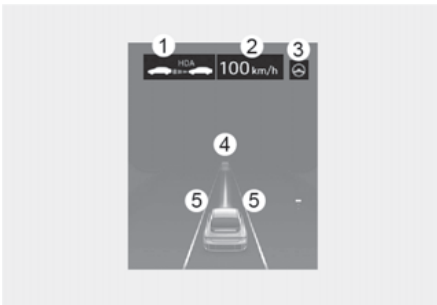

Standby state

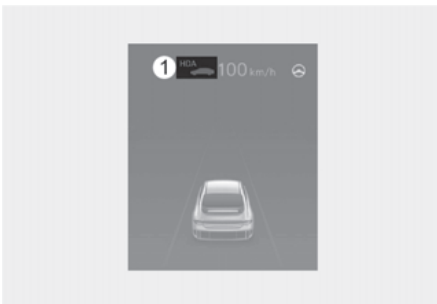

1. Highway Driving Assist indicator, whether there is a vehicle ahead and the selected distance level are displayed.

- Highway Driving Assist indicator (HDA)
 - Green HDA: Operating state
 - Grey HDA: Standby state
 - White HDA blink: Accelerator depressed state

2. Set speed

3. Lane Following Assist indicator

4. Whether there is a vehicle ahead and the selected headway

5. Whether the lane is detected or not

i Information

- For more information on the display, refer to the "Smart Cruise Control (SCC)" and "Lane Following Assist (LFA)" sections in this chapter.
- The images and colors in the instrument cluster may differ depending on the cluster type or theme selected from the settings menu.

Highway Driving Assist operation

Highway Driving Assist operates when:

- Driving on the main road of highways, and turning on Highway Driving Assist by pressing the Driving Assist button
- Entering the main road of highways while Lane Following assist and Smart Cruise Control are operating

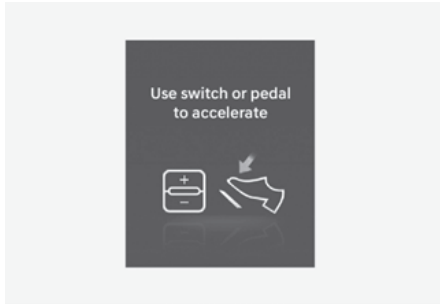

Restarting after stopping

When Highway Driving Assist is operating, your vehicle will stop if the vehicle ahead of you stops. Also, if the vehicle ahead of you starts moving within 30 seconds after the stop, your vehicle will start as well. In addition, after the vehicle has stopped and 30 seconds have passed, the '**Use switch or pedal to accelerate**' message will appear on the instrument cluster. Depress the accelerator pedal or operate the + switch, - switch or  switch to start driving.

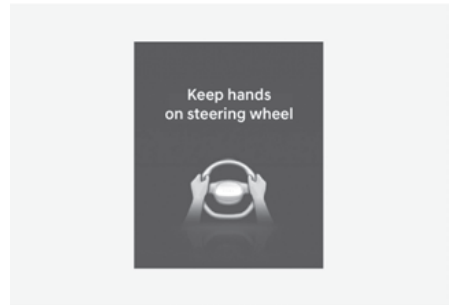

Hands-off warning

If the driver takes their hands off the steering wheel for several seconds, the **'Keep hands on steering wheel'** warning message will appear and an audible warning will sound in stages.

First stage: Warning message

Second stage: Warning message (red steering wheel) and audible warning

Type A/Type B

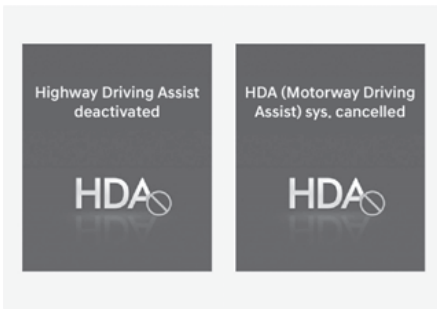

If the driver still does not have their hands on the steering wheel after the hands-off warning, **'HDA(Motorway Driving Assist) sys. cancelled'** (or **'Highway Driving Assist deactivated'**) warning message will appear and Highway Driving Assist and Lane Change Assist will be automatically cancelled.

Type A/Type B

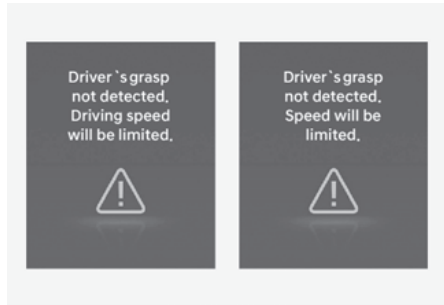

Driving speed limit

When Highway Driving Assist is cancelled by the hands-off warning, The driving speed will be limited.

While Driving Speed Limit function is operating, the **'Driver's grasp not detected. Speed will be limited'** (or **'Driver's grasp not detected. Driving speed will be limited'**) warning message will appear on the instrument cluster, and an audible warning will sound continuously.

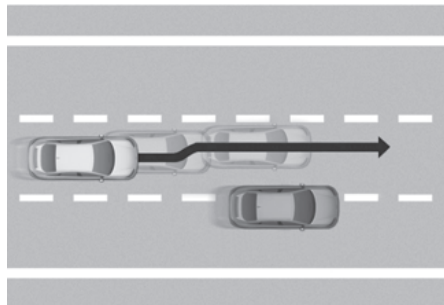

Driving to one side within lane (if equipped)

When vehicle speed is above 60 km/h (40 mph), if a vehicle around you is driving at a close distance, your vehicle will control steering in the opposite direction of the vehicle to assist in safe driving.

If there are vehicles in both sides of the lane that are driving close to you, the function will not veer to the opposite side of the lane.

Highway Driving Assist standby

When the Smart Cruise Control is temporarily cancelled while Highway Driving Assist is operating, Highway Driving Assist will be in the standby state. At this time, Lane Following Assist will operate properly.

i Information

- Driving Speed Limit helps you drive below 60 km/h (40 mph). At this time, the vehicle decelerates due to the vehicle ahead. After the vehicle has decelerated, it cannot automatically accelerate.
- Driving Speed Limit will cancel in the following circumstances:
 - When the driver grabs the steering wheel again
 - When the driver turns on Lane Following Assist by pressing the Lane Driving Assist button
 - When +, -, II↻ switch or  button is operated, or the accelerator pedal or the brake pedal is depressed

Highway Lane Change Assist

 if equipped

Displaying operating status

You can see the status of the Highway Lane Change Assist function operation in the Driving Assist view on the instrument cluster. Refer to the "View modes" section in chapter 4.

Highway Lane Change Assist function will be displayed as below depending on the status of the function.





Ready/Operating



Standby/Canceled



1. Highway Lane Change Assist indicator

- Green  on: Ready state
- Green  blink: Operating state
- Grey  on: Standby state
- White  blink: Canceled state (display only a certain time)

2. Lane line

The lane line is displayed same as the Highway Lane Change Assist indicator (1). However, if the function is on standby, it displays whether the lane line is detected.

3. Green arrow and shade

The green arrow is displayed when a certain amount of time has passed after the function has started operating, and until the lane change has completed.

4. Message

- Message is displayed when the function does not operate even though the turn signal is used.
- Message is displayed when the function is cancelled while operating.

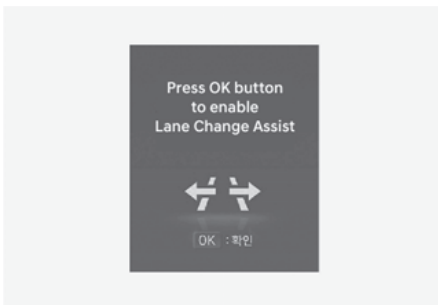

To turn on Highway Lane Change Assist

Highway Lane Change Assist function will turn on when the following conditions are satisfied.

- The Driving Assist button or Lane Driving Assist button is used to turn on Highway Driving Assist.
- The OK button is pressed on the steering wheel while a message asking to use Highway Lane Change Assist is displayed on the instrument cluster.

Highway Lane Change Assist ready to operate

While Highway Lane Change Assist function is on, the function will be ready to operate when all the following conditions are satisfied:

- Highway Driving Assist is operating
- Lane Following Assist is operating
- A vehicle in the rear area of your vehicle is detected more than once after the vehicle is turned on
- Your vehicle speed is above 60 km/h (40 mph)
- Hands-off warning is not displayed on the instrument cluster
- Hazard warning flasher is off

i Information

- While Lane Change Assist function is turned on (indicator on), Lane Following Assist will not cancel even if the turn signal indicator or hazard warning flasher is operating.
- Lane Change Assist function turns off automatically when driven in the following road conditions:
 - One driving lane
 - A road with a intersection or crosswalk ahead
 - A road with no structure, such as a medium strip, guardrails, etc.
 - There is a pedestrian or cyclist on the road ahead
- When the function is in the ready state, and vehicle speed is below 55 km/h (34 mph), the function will change to the standby state.

! WARNING

When Highway Lane Change Assist function turns off while operating, steering assist will be temporarily cancelled. Always be cautious while driving.

Highway Lane Change Assist operating

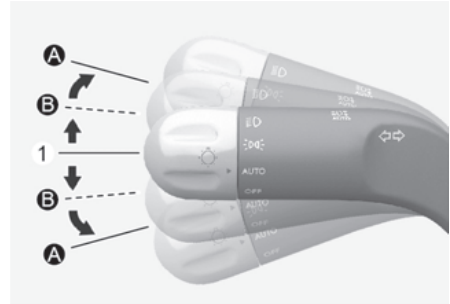

(1) Center

Highway Lane Change Assist function will operate, when you push the turn signal lever up or down to the A or B position while the function is in the ready state (↔ indicator is green), and all of the following conditions are satisfied:

- The driver has his/her hand on the steering wheel
- There is no collision risk in the direction of lane change
- There is a single dotted lane line in the direction of lane change
- There are no Forward Collision-Avoidance Assist and Blind Spot Collision-Avoidance Assist warnings
- The vehicle is driven in the middle of the lane (should not be driving close to one side of the lane)
- The road you are driving on, or the road you are about to change lane is a road that the function can operate

i Information

- Highway Lane Change Assist operates when the turn signal lever is positioned at A. If the turn signal lever is released to the center (1) before stepping on the lane, Highway Lane Change Assist cancels. If the turn signal lever is released to the center (1) after stepping on the lane, Highway Lane Change Assist changes the lane and turns off the turn signal after lane change is complete.
 - When the turn signal lever is placed at B position for a certain period of time, the green arrow will appear. At this time, even when the lever is released and returns to its original position (1), lane change will still be assisted.
 - While lane change is being made by the function, the turn signal indicator will blink even when the turn signal lever is not held, and the turn signal indicator will turn off when lane change is complete.
-

Highway Lane Change Assist standby

Highway Lane Change Assist function will be in the standby state when one of the ready state condition is not satisfied, or when entering or driving on one of the following roads:

- Road within a certain distance from the tollgate on the main road of the highway (or motorway)
- The road ahead ends without an interchange or junction
- Road with sharp curves
- Road with narrow lanes

Highway Lane Change Assist cancel

The function will be canceled when:

- The turn signal lever is moved to the A position while the Highway Lane Change Assist function is operating and placed in the center (1) before stepping on the lane line
- The turn signal lever is turned on in the opposite direction of lane change
- The steering wheel is steered sharply

WARNING

- While Highway Driving Assist is operating, the function will cancel if one of the following occurs:
 - Highway Driving Assist is turned off
 - Lane Following Assist or Smart Cruise Control is turned off or temporarily canceled
 - Hands-off warning message is displayed on the instrument cluster
 - The hazard warning flasher is turned on
 - Forward Collision-Avoidance Assist or Blind-Spot Collision Warning warning message is displayed
 - Possible collision is detected in the next lane, even though there are no Forward Collision-Avoidance Assist and Blind-Spot Collision-Avoidance warning
 - The target lane to make a lane change disappears
 - The target lane to make a lane change is not detected
 - There is a problem with turn signal lights
 - Highway Lane Change Assist function is off (The function turns off when the function is turned off from the settings menu, when the road changes to a one-way road, when there is a intersection or crosswalk ahead, when you enter a road with no structure, such as a medium strip, guardrail, etc., or when there is a pedestrian or cyclist on the driving lane.)
 - Your vehicle speed is below 55 km/h (35 mph)
 - While the function is operating, when the function is canceled, depending on the driving conditions, the vehicle may drive to the middle of the driving lane or steering assist may stop. Always pay attention to road and driving conditions while driving.
 - The function may not operate properly on roads with pedestrians or cyclists, such as an intersection or crosswalk. Always pay attention to road and driving conditions while driving.
-

Highway Driving Assist Malfunction and Limitations

Highway Driving Assist malfunction

Type A/Type B

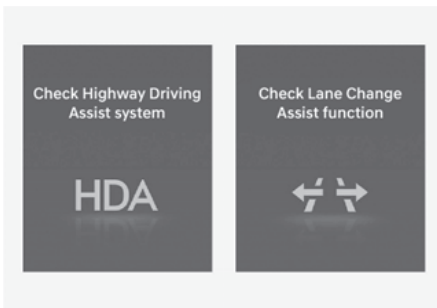

When Highway Driving Assist or Highway Lane Change function is not working properly, the 'Check Highway Driving Assist (HDA) system' or 'Check Lane Change Assist function' warning message will appear, and the Δ warning light will illuminate on the instrument cluster. We recommend that the vehicle be inspected by an authorized HYUNDAI dealer.

WARNING

- The driver is responsible for controlling the vehicle for safe driving.
- Always have your hands on the steering wheel while driving.
- Highway Driving Assist is a supplemental function that assists the driver in driving the vehicle and is not a complete autonomous driving system. Always check road conditions, and if necessary, take appropriate actions to drive safely.
- Always have your eyes on the road, and it is the responsibility of the driver to avoid violating traffic laws. The vehicle manufacturer is not responsible for any traffic violation or accidents caused by the driver.
- Highway Driving Assist may not be able to recognize all traffic situations. Highway Driving Assist may not detect possible collisions due to limitations of the function. Always be aware of the limitations of the function. Obstacles such as vehicles, motorcycles, bicycles, pedestrians, or unspecified objects or structures such as guardrails, tollgate, etc., that may collide with the vehicle may not be detected.
- Highway Driving Assist will turn off automatically under the following situations:
 - Driving on roads that Highway Driving Assist does not operate, such as a rest area, intersection, junction, etc.
 - The navigation does not operate properly such as when the navigation is being updated or restarted
- Highway Driving Assist may inadvertently operate or turn off depending on road conditions (navigation information) and surroundings.
- Lane Following Assist function may be temporarily disabled when the front view camera cannot detect lanes properly or the hands-off warning is on.
- You may not hear the warning sound of Highway Driving Assist if the surrounding is noisy.

- If the vehicle is driven at high speed above a certain speed at a curve, your vehicle may drive to one side or may depart from the driving lane.
- When you are towing a trailer or another vehicle, turn off Highway Driving Assist for safety reasons.
- The hands-off warning message may appear early or late depending on how the steering wheel is held or road conditions. Always have your hands on the steering wheel while driving.
- For your safety, please read the owner's manual before using the Highway Driving Assist.
- Highway Driving Assist will not operate when the vehicle is started, or when the detecting sensors or navigation is being initialized.
- The driver goes off course or the route to the destination is changed or canceled by resetting the navigation
- The vehicle enters a service station or rest area
- Android Auto or Car Play is operating
- The navigation cannot detect the current vehicle position (for example, elevated roads including overpass adjacent to general roads or nearby roads exist in a parallel way)
- White single dotted lane line or road edge cannot be detected
- The road is temporarily controlled due to construction, etc.
- There is no structure, such as a medium strip, guardrails, etc., on the road
- There is a changeable lane in the direction of lane change

Limitation of Highway Driving Assist

Highway Driving Assist and Highway Lane Change function may not operate properly, or may not operate under the following circumstances:

- The map information and the actual road is different because the navigation is not updated
- The map information and the actual road is different because of real-time GPS data or map information error
- The infotainment system is overloaded by simultaneously performing functions such as route search, video playback, voice recognition, etc.
- GPS signals are blocked in areas such as a tunnel

***i* Information**

For more information on the limitations of the front view camera, front radar, front corner radar and rear corner radar, refer to the "Forward Collision Avoidance Assist (FCA)" section in this chapter.

Rear View Monitor (RVM)

 If equipped

Rear View Monitor displays the area behind your vehicle to help with safe parking or driving.

Detecting sensor

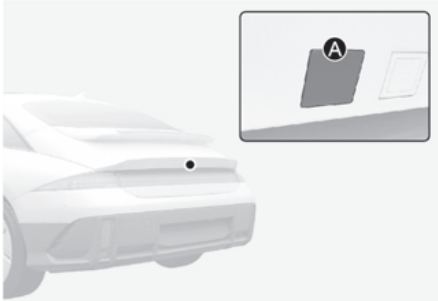

[A] Wide-rear view camera

Refer to the picture above for the detailed location of the detecting sensor.

Rear View Monitor settings

Warning Methods

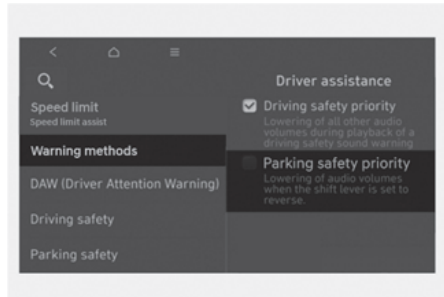

With the vehicle on, go to **Setup > Vehicle > Driver assistance > Warning methods (select speaker icon)** from the Settings in the infotainment system to select the following:

- **Parking safety priority:** Your vehicle lowers all other audio volumes when Rear View Monitor is operating.

i Information

- If you change the Warning methods, Warning methods of other Driver Assistance systems may change.
- If the vehicle is restarted, Warning methods will maintain the last setting.
- There may be no Settings menu depending on the feature applied to your vehicle.

Camera settings

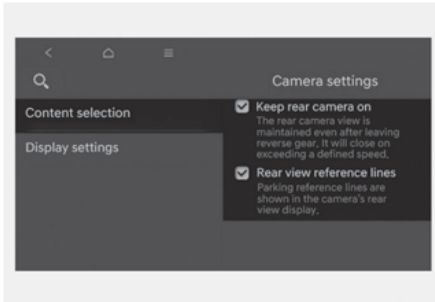

- You can change Rear View Monitor "Content selection" by touching the setup icon (⚙️) on the screen while Surround View Monitor is operating, or selecting **Setup > Vehicle > Driver assistance > Parking safety > Camera settings** from the Settings menu while the vehicle is on.
- Content selection, you can change settings for "Rear view reference lines".

i Information

There may be no Setting menu depending on the vehicle specification.

Keep rear camera on

With the vehicle on, select **Camera settings > Content selection > Keep rear camera on** from the Settings menu to turn on Keep rear camera on function and deselect to turn off the function

Rear view reference lines

If "Rear view reference lines" is selected, the rear view parking guide lines and rear top view guide lines will be displayed at the left side of the infotainment system.

i Information

- The horizontal guideline of the Rear View Parking Guidance shows the distance of 0.5 m (20 in), 1 m (40 in) and 2.3 m (91 in) from the vehicle.
- The horizontal guideline of the Rear Top View Parking Guidance shows the distance 0.5 m (20 in) and 1.5 m (60 in) from the vehicle.

Rear View Monitor operation

Parking/View button



Press the Parking/View button (1) while the gear is in P (Park) to turn on Rear View Monitor.

Press the Parking/View button (1) while the gear is in D (Drive) or N (Neutral) to turn on Rear View Monitor while driving.

Rear view



Operating conditions

- Shift the gear to R (Reverse), the rear view will appear on the screen.
- Press the Parking/View button (1) while the gear is in P (Park), the rear view will appear on the screen.
- Touch the , the rear view will appear on the screen.

Off conditions

- The rear view cannot be turned off when the gear is in R (Reverse).
- Press the Parking/View button (1) again while the gear is in P (Park) with the rear view on the screen, the rear view will turn off.
- Shift the gear from R (Reverse) to P (Park), the rear view will turn off.

Information

When the gear is in R (Reverse), the rear view does not turn off.

Rear top view



When you touch the  icon, the top view is displayed on the screen and shows the distance from the vehicle in the back of your vehicle while parking.

Extended Rear View Monitor

Extended Rear View Monitor function maintains showing the rear view when the gear is R (Reverse), N (Neutral) or D (Drive).

Operating conditions

The gear is in P (Park), N (Neutral) or D (Drive), and vehicle speed is 10 km/h (6 mph) or less.

Off conditions

- When vehicle speed is above 10 km/h (6 mph), the rear view will turn off.
- Shift the gear to P (Park), the rear view will turn off.
- Press the Parking/View button (1), the rear view will turn off.

Rear View while driving



The driver is able to check the rear view on the screen while driving, it is to assist with backing up.

Operating conditions

Press the Parking/View button (1) while the gear is in D (Drive) or N (Neutral), the driving rear view will appear on the screen.

Off conditions

- Press the Parking/View button (1) again, the driving rear view will turn off.
- Press one of the infotainment system button (2), the driving rear view will turn off.
- Shift the gear to P (Park), the driving rear view will turn off.

When operating

If the gear is shifted to R (Reverse), while Driving rear view is displayed on the screen, the screen will change to rear view.

Rear View Monitor malfunction and limitations

Rear View Monitor malfunction

When Rear View Monitor is not working properly, or the screen flickers, or the camera image does not display properly, we recommend that you have the vehicle inspected by an authorized HYUNDAI dealer.

Limitations of Rear View Monitor

When the vehicle is stopped for a long time in winter or when the vehicle is parked in an indoor parking lot, the exhaust fumes may temporarily blur the image.

WARNING

- The rear view camera does not cover the complete area behind the vehicle. The driver should always check the rear area directly through the inside and outside rearview mirror before parking or backing up.
- The image shown on the screen may differ from the actual distance of the object. Make sure to directly check the vehicle's surroundings for safety.
- Always keep the rear view camera lens clean. If the lens is covered with foreign material, it may adversely affect camera performance and Rear View Monitor may not operate properly. However, do not use chemical solvents such as strong detergents containing high alkaline or volatile organic solvents (gasoline, acetone, etc.). This may damage the camera lens.

Surround View Monitor (SVM)

 If equipped

Surround View Monitor uses the wide view cameras and displays images around your vehicle through the infotainment system screen to help with safe parking or driving.

Detecting sensor

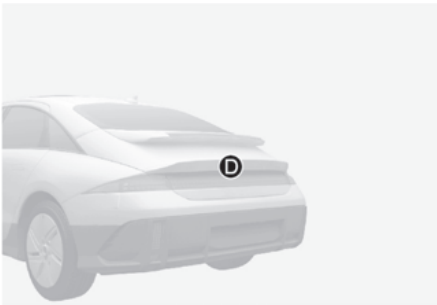
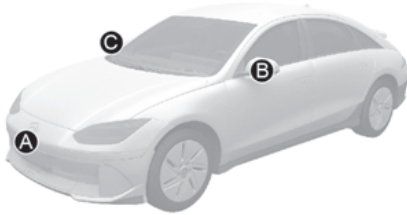

- [A] Wide-front view camera
- [B] Wide-side view camera (Below the outside rearview mirror)
- [C] Wide-side view camera (Below the outside rearview mirror)
- [D] Wide-rear view camera

Refer to the picture above for the detailed location of the detecting sensors.

Surround View Monitor settings

Warning Methods

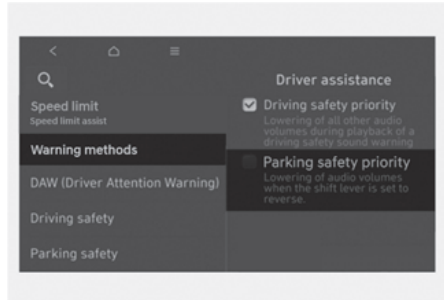

With the vehicle on, go to **Setup > Vehicle > Driver assistance > Warning methods (select speaker icon)** from the Settings in the infotainment system to select the following:

- **Parking safety priority:** Your vehicle lowers all other audio volumes when Surround View Monitor is operating.

Information

- If you change the Warning methods, Warning methods of other Driver Assistance systems may change.
- If the vehicle is restarted, Warning methods will maintain the last setting.
- There may be no Settings menu depending on the feature applied to your vehicle.

Camera settings

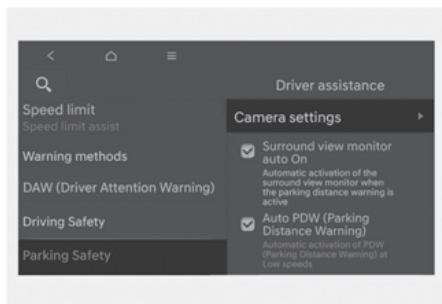

- You can change Surround View Monitor 'Display Contents' or 'Display Settings' by touching the setup icon (⚙️) on the screen while Surround View Monitor is operating, or selecting **Setup (Settings) > Vehicle > Driver assistance > Parking safety > Camera settings** from the Settings menu while the vehicle is on.
- In the Display Contents, you can change settings for 'Top View Parking Lines (Top view reference lines)', 'Rear View Parking Lines (Rear view reference lines)' and 'Parking Distance Warning'.

i Information

There may be no Setting menu depending on the vehicle specification.

Parking Distance Warning

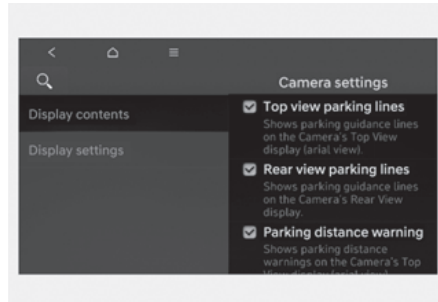

When the 'Parking Distance Warning' is selected, parking distance warning is displayed on the right side of the Surround View Monitor screen.

Top View Parking Guidance

When the 'Top View Parking Lines (Top view reference lines)' is selected, parking guidance is displayed on the right side of the Surround View Monitor screen.

i Information

The horizontal guideline of the Rear Top View Parking Guidance shows the trunk opening distance and the distance of 0.5 m (20 in) and 2 m (79 in) from the vehicle.

Rear View Parking Guidance

When the 'Rear View Parking Lines (Rear view reference lines)' is selected, parking guidance is displayed in the rear view.

i Information

The horizontal guideline shows the distance of 0.5 m (20 in), 1 m (40 in) and 2.3 m (91 in) from the vehicle.

Surround View Monitor Auto On

With the vehicle on, select **Driver assistance > Parking safety > Surround view monitor on** from the Settings menu to use the function.

i Information

For more information on Surround view monitor auto On, refer to the "Surround View Monitor (SVM)" in this chapter.

Surround View Monitor operation

Parking/View button



Press the Parking/View button (1) to turn on Surround View Monitor.

Press the button again to turn off the function.

Front view



The front image is displayed on the screen when the gear is in N (Neutral) or D (Drive) to assist in parking. Using the view button (2) you may select top view, front view, side view.

Operating conditions

- The gear is in N (Neutral) or D (Drive), and vehicle speed is 10 km/h (6 mph) or less.
- The Parking/View button (1) is pressed, while the gear is in N (Neutral) or D (Drive), and vehicle speed is 10 km/h (6 mph) or less.
- Surround View Monitor Auto On function will operate when the following conditions are satisfied:
 - With **Driver assistance > Parking safety > Surround view monitor on** selected from the Settings menu, the front view while parking is displayed.

Off conditions

- The Parking/View button (1) or the Infotainment system button (3) is Pressed.
- Vehicle speed is above 10 km/h (6 mph).
- The gear is shifted to P (park).

i Information

Surround View Monitor will turn off when vehicle speed is above 10 km/h (6 mph). However, Surround View Monitor will not turn on again although vehicle speed drops below 10 km/h (6 mph).

Rear view

The rear image is displayed on the screen when the gear is in R (Reverse) or P (Park) to assist in parking. Using the view button (2) you may select top view, front view, side view.

Operating conditions

- The gear is shifted to R (Reverse)
- The Parking/View button (1) is pressed, while the gear is in P (Park)

Off conditions

- The gear is shifted from R (Reverse) to P (Park)
- The Parking/View button (1) is pressed, while the gear is in P (Park)

i Information

When the gear is in R (reverse), the infotainment system button (3) is pressed does not turn off.

Rear View while driving

The driver is able to check the rear view on the screen while driving, it is to assist with backing up. Also, you can change the view mode you want to select by pressing the view button (2) on the infotainment system.

Rear View while driving function will turn on under the following conditions:

- The Parking/View button (1) is pressed, while driving above 10 km/h (6 mph).
- **1** is selected among the view buttons (2) when vehicle speed is 10 km/h (6 mph) or less.

Rear View while driving function will turn off under the following conditions:

- The Parking/View button (1) or the infotainment system button (3) is pressed.
- The gear is shifted to P (Park).
- Other view modes are selected when vehicle speed is 10 km/h (6 mph) or less.

***i* Information**

- When Rear View while driving is on, it stays on while driving regardless of vehicle speed.
 - When Rear View while driving is on while backing up, the screen changes to the rear view.
 - When the rear view while driving is turned on again, the previous view mode will be displayed.
-

3D view

The 3D view shows the image around the vehicle from various angles.

You can change angles by tapping the screen. Press the 3D View button again to return to the initial angle.

3D view will turn on when the 3D view is selected among the view buttons (2) under the following conditions:

- The gear is in P (Park), N (Neutral) or D (Drive) when vehicle speed is below 10 km/h (6 mph).
- The Surround View Monitor is turned on when the gear is in R (Reverse).

When the gear is in P (Park), N (Neutral) or D (Drive), 3D view will turn off under the following conditions:

- The gear is shifted to P (Park).
- The Parking/View button (1) is pressed.
- The infotainment system button (3) is pressed.
- The Home button (2) is pressed.
- Vehicle speed is above 10 km/h (6 mph).

When the gear is in R (reverse), 3D view will turn off under the following conditions.

- The gear is shifted to P (Park).

***i* Information**

3D view does not display guidelines.

Surround View Monitor malfunction and limitations

Surround View Monitor malfunction

When Surround View Monitor is not working properly, or the screen flickers, or the camera image does not display properly, we recommend that you have the vehicle inspected by an authorized HYUNDAI dealer.

Limitations of Surround View Monitor

- When the vehicle is stopped for a long time in winter or when the vehicle is parked in an indoor parking lot, the exhaust fumes may temporarily blur the image.
- The screen may be displayed abnormally, and an icon will appear at the top left side of the screen under the following circumstances:
 - The trunk is opened
 - The driver or front passenger door is opened
 - The rear view mirror is folded

WARNING

- ALWAYS look around your vehicle to make sure there are no objects or obstacles before moving the vehicle. What you see on the screen may differ from the actual vehicle's location.
- The image shown on the screen may differ from the actual distance of the object. Make sure to directly check the vehicle's surroundings for safety.
- Surround View Monitor is designed to be used on a flat surface.

Therefore, if used on roads with different heights such as curbs and speed bumps, the image in the screen may not look correct.

- Always keep the camera lens clean.

If the lens is covered with foreign material, it may adversely affect camera performance and Surround View Monitor may not operate properly. However, do not use chemical solvents such as strong detergents containing high alkaline or volatile organic solvents (gasoline, acetone, etc.). This may damage the camera lens.

Information

Surround View Monitor uses the cameras installed on the vehicle to show images around the vehicle through the infotainment system. The image shown on the screen may look unnatural depending on the surroundings.

Rear Cross-Traffic Collision-Avoidance Assist (RCCA)

 If equipped

Rear Cross-Traffic Collision-Avoidance Assist detects vehicles approaching from the rear left or right while your vehicle is reversing and warns you of a possible collision with a warning message and a warning sound. Also, Rear Cross-Traffic Collision-Avoidance Assist may assist with braking your vehicle to help avoid a collision.

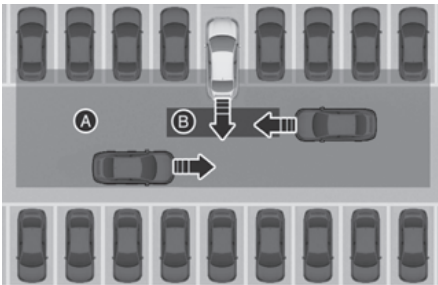

[A] Rear Cross-Traffic Collision Warning operating range,

[B] Rear Cross-Traffic Collision-Avoidance Assist operating range

CAUTION

Warning timing may vary depending on the speed of the approaching vehicle.

Detecting sensor



[A] Rear corner radar

Refer to the picture above for the detailed location of the detecting sensors.

Information

For more information on the precautions of the rear corner radar, refer to the "Blind-Spot Collision-Avoidance Assist (BCA)" section in this chapter.

Rear Cross-Traffic Collision-Avoidance Assist settings

Rear Cross-Traffic Safety

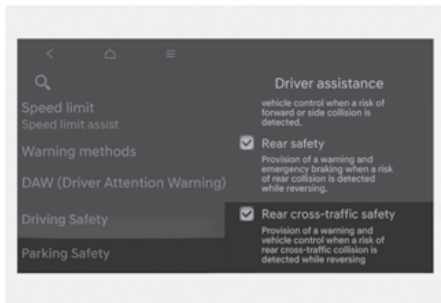

With the vehicle on, select **Setup (Settings) > Vehicle > Parking safety > Rear cross-traffic safety** from the settings menu to turn on Rear Cross-Traffic Collision-Avoidance Assist and deselect to turn off the function.

WARNING

When the vehicle is restarted, Rear Cross-Traffic Collision-Avoidance Assist will always turn on. However, if 'Off' is selected after the vehicle is restarted, the driver should always be aware of the surroundings and drive safely.

Warning Methods

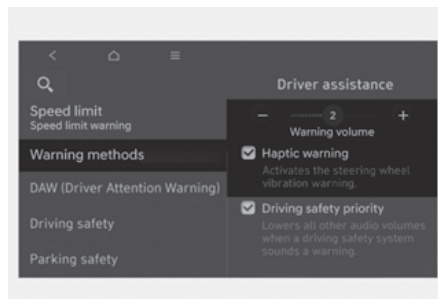

With the vehicle on, go to **Setup > Vehicle > Driver assistance > Warning methods (select speaker icon)** from the Settings in the infotainment system to select the following:

- **Warning volume:** The Warning volume can be adjusted.
- **Haptic warning:** The steering wheel vibration can be set. (if equipped)

Information

- If you change the Warning methods, Warning methods of other Driver Assistance systems may change.
- If the vehicle is restarted, Warning methods will maintain the last setting.
- There may be no settings menu depending on the feature applied to your vehicle.

Rear Cross-Traffic Collision-Avoidance Assist operation

Rear Cross-Traffic Collision-Avoidance Assist will warn and help control the vehicle depending on collision risk level: 'Collision Warning', 'Emergency Braking' and 'Stopping vehicle and ending brake control'.

Collision Warning



- To warn the driver of an approaching vehicle from the rear left/right side of your vehicle, the warning light on the outside rearview mirror will blink and a warning will appear on the instrument cluster. At the same time, an audible warning will sound. If Rear View Monitor is operating, a warning will also appear on the infotainment system.
- Rear Cross-Traffic Collision-Avoidance Assist will operate when all the following conditions are satisfied:
 - The gear is shifted to R (Reverse)
 - Vehicle speed is below 8 km/h (5 mph)
 - The approaching vehicle is within about 25 m (82 ft.) from the left and right side of your vehicle
 - The speed of the vehicle approaching from the left and right is above 5 km/h (3 mph)

i Information

- If the operating conditions are satisfied, there will be a warning whenever the vehicle approaches from the left or right side even though your vehicle speed is 0 km/h (0 mph).
- The images and colors in the instrument cluster may differ depending on the cluster type or theme selected from the instrument cluster.

Emergency Braking



- To warn the driver of an approaching vehicle from the rear left/right side of your vehicle, the warning light on the outside rearview mirror will blink and a warning message will appear on the instrument cluster. At the same time, an audible warning will sound. A warning will also appear on the infotainment system.
- Rear Cross-Traffic Collision-Avoidance Assist will operate when all the following conditions are satisfied:
 - The gear is shifted to R (Reverse)
 - Vehicle speed is below 8 km/h (5 mph)
 - The approaching vehicle is within about 1.5 m (5 ft.) from the left and right side of your vehicle
 - The speed of the vehicle approaching from the left and right is above 5 km/h (3 mph)
- Emergency braking will be assisted to help prevent collision with approaching vehicles from the left and right.

WARNING

Brake control will end when:

- The approaching vehicle is out of the detecting range
- The approaching vehicle passes behind your vehicle
- The approaching vehicle does not drive toward your vehicle
- The approaching vehicle speed slows down
- The driver depresses the brake pedal with sufficient power

Stopping vehicle and ending brake control



- When the vehicle is stopped due to emergency braking, the '**Drive carefully**' warning message will appear on the instrument cluster.
 - For your safety, the driver should depress the brake pedal immediately and check the surroundings.
 - Brake control will end after the vehicle is stopped by emergency braking for about 2 seconds.
 - During emergency braking, braking control by Rear Cross-Traffic Collision-Avoidance Assist will automatically cancel when the driver excessively depresses the brake pedal.
-  **WARNING**
- Take the following precautions when using Rear Cross-Traffic Collision-Avoidance Assist:
- For your safety, only change the Settings after parking the vehicle at a safe location.
 - If any other system's warning message is displayed or audible warning is generated, Rear Cross-Traffic Collision-Avoidance Assist warning message may not be displayed and audible warning may not be generated.
 - You may not hear the warning sound of Rear Cross-Traffic Collision-Avoidance Assist if the surrounding is noisy.
 - Rear Cross-Traffic Collision-Avoidance Assist may not operate if the driver applies the brake pedal to avoid collision.
 - During Rear Cross-Traffic Collision-Avoidance Assist operation, the vehicle may stop suddenly injuring passengers and shifting loose objects. Always have the seat belt on and keep loose objects secured.
 - Even if there is a problem with Rear Cross-Traffic Collision-Avoidance Assist, the vehicle's basic braking performance will operate properly.
 - When Rear Cross-Traffic Collision-Avoidance Assist is operating, braking control by the function will automatically cancel when the driver excessively depresses the accelerator pedal.

- Rear Cross-Traffic Collision-Avoidance Assist does not operate in all situations or cannot avoid all collisions.
- Rear Cross-Traffic Collision-Avoidance Assist may warn the driver late or may not warn the driver depending on the road and driving conditions.
- The driver has the responsibility to control the vehicle. Do not solely depend on Rear Cross-Traffic Collision-Avoidance Assist. Rather, maintain a safe braking distance, and if necessary, depress the brake pedal to reduce driving speed or to stop the vehicle.
- Never deliberately operate Rear Cross-Traffic Collision-Avoidance Assist on people, animal, objects, etc. It may cause serious injury or death.

CAUTION

The brake control may not operate properly depending on the status of ESC (Electronic Stability Control).

There will only be a warning when:

- The ESC (Electronic Stability Control) warning light is on
- ESC (Electronic Stability Control) is engaged in a different function

i Information

If braking is assisted by Rear Cross-Traffic Collision-Avoidance Assist, the driver must immediately depress the brake pedal and check vehicle surroundings.

- Brake control will end when the driver depresses the brake pedal with sufficient power.
- After shifting the gear to R (Reverse), braking control will operate once for left and right vehicle approach.

Rear Cross-Traffic Collision-Avoidance Assist malfunction and limitations

Rear Cross-Traffic Collision-Avoidance Assist malfunction

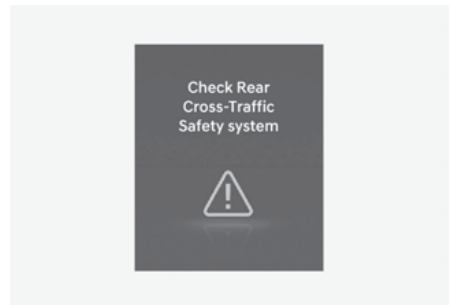

When Rear Cross-Traffic Collision-Avoidance Assist is not working properly, the **'Check Rear Cross-Traffic Safety system'** warning message will appear on the instrument cluster for several seconds, and the master () warning light will illuminate on the instrument cluster. If this occur, we recommend that the vehicle be inspected by an authorized HYUNDAI dealer.

Type A/Type B

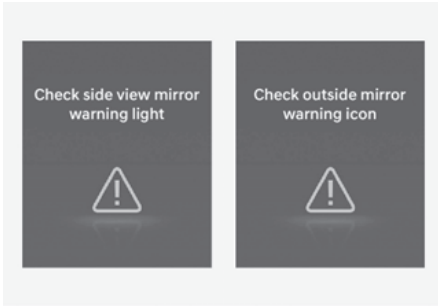

When the outside rearview mirror warning light is not working properly, the **'Check side view mirror warning light'** (or **'Check outside mirror warning icon'**) warning message will appear on the instrument cluster for several seconds, and the master (⚠) warning light will illuminate on the instrument cluster. If this occurs, we recommend that you have the vehicle inspected by an authorized HYUNDAI dealer.

Rear Cross-Traffic Collision-Avoidance Assist disabled

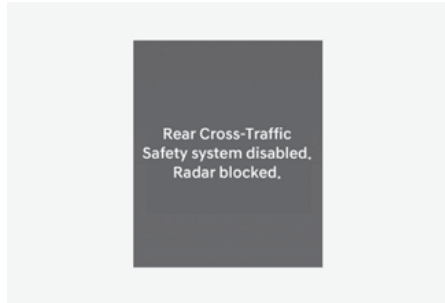

When the rear bumper around the rear-side radar or sensor is covered with foreign material, such as snow or rain, or installing a trailer or carrier, it can reduce the detecting performance and temporarily limit or disable Rear Cross-Traffic Collision-Avoidance Assist.

If this occurs, the **'Rear Cross-Traffic Safety system disabled. Radar blocked'** warning message will appear on the instrument cluster.

Rear Cross-Traffic Collision-Avoidance Assist will operate properly when such foreign material or trailer, etc., is removed.

If Rear Cross-Traffic Collision-Avoidance Assist does not operate properly after it is removed, we recommend that you have the vehicle inspected by an authorized HYUNDAI dealer.

⚠ WARNING

- Even though the warning message does not appear on the instrument cluster, Rear Cross-Traffic Collision-Avoidance Assist may not operate properly.
- Rear Cross-Traffic Collision-Avoidance Assist may not operate properly in an area (for example, open terrain), where any objects are not detected after turning ON the vehicle.

⚠ CAUTION

Turn off Rear Cross-Traffic Collision-Avoidance Assist to install or remove a trailer, carrier, or another attachment. Turn on Rear Cross-Traffic Collision-Avoidance Assist when finished.

Limitations of Rear Cross-Traffic Collision-Avoidance Assist

Rear Cross-Traffic Collision-Avoidance Assist may not operate properly, or it may operate unexpectedly under the following circumstances:

- Departing from where trees or grass are overgrown
- Departing from where roads are wet
- Speed of the approaching vehicle is fast or slow

Braking control may not work, driver's attention is required in the following circumstances:

- The vehicle severely vibrates while driving over a bumpy road, uneven road or concrete patch
- Driving on a slippery surface due to snow, water puddle, ice, etc.
- The tire pressure is low or a tire is damaged
- The braking system has been modified
- Remote Smart Parking Assist is operating (if equipped)

***i* Information**

For more information on the limitations of the rear corner radar, refer to the "Blind-Spot Collision-Avoidance Assist (BCA)" section in this chapter.

 **WARNING**

- Driving near a vehicle or structure

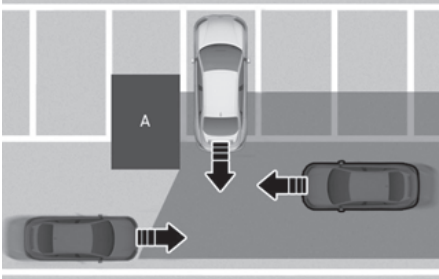

[A] Structure

Rear Cross-Traffic Collision-Avoidance Assist may be limited when driving near a vehicle or structure, and may not detect the vehicle approaching from the left or right. If this occurs, the function may not warn the driver or control the brakes when necessary.

Always check your surroundings while backing up.

- When the vehicle is in a complex parking environment

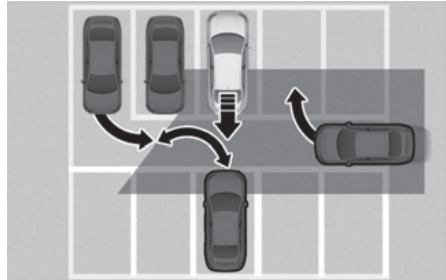

Rear Cross-Traffic Collision-Avoidance Assist may detect vehicles which are parking or pulling out near your vehicle (for example, a vehicle leaving beside your vehicle, a vehicle parking or pulling out in the rear area, a vehicle approaching your vehicle making a turn, etc.). If this occurs, the function may unnecessarily warn the driver and control the brake.

Always check your surroundings while backing up.

- When the vehicle is parked diagonally

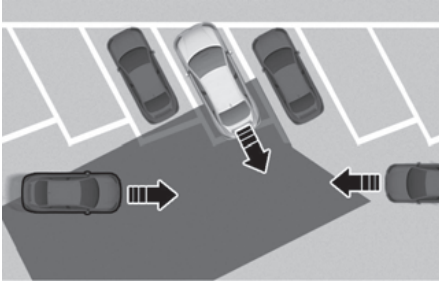

Rear Cross-Traffic Collision-Avoidance Assist may be limited when backing up diagonally, and may not detect the vehicle approaching from the left or right. If this occurs, the function may not warn the driver or control the brakes when necessary.

Always check your surroundings while backing up.

- When the vehicle is on or near a slope

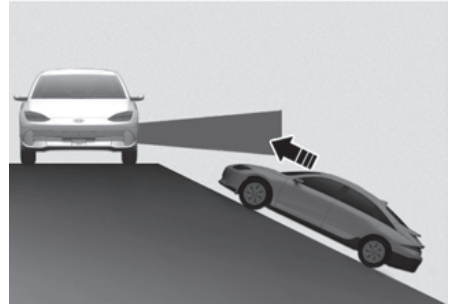

Rear Cross-Traffic Collision-Avoidance Assist may be limited when the vehicle is on an uphill or downhill slope, or near it, and may not detect the vehicle approaching from the left or right. If this occurs, the function may not warn the driver or control the brakes when necessary.

Always check your surroundings while backing up.

- Pulling into the parking space where there is a structure

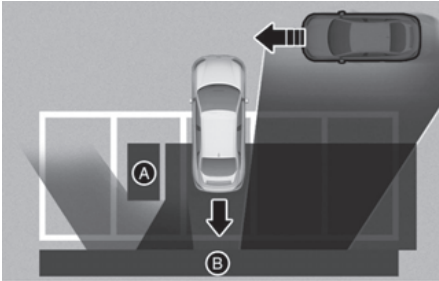

[A] Structure
[B] Wall

Rear Cross-Traffic Collision-Avoidance Assist may detect vehicles passing by in front of you when parking in reverse into a parking space with a wall or structure in the rear or side area. If this occurs, the function may unnecessarily warn the driver and control the brake.

Always check your surroundings while backing up.

- When the vehicle is parked rearward

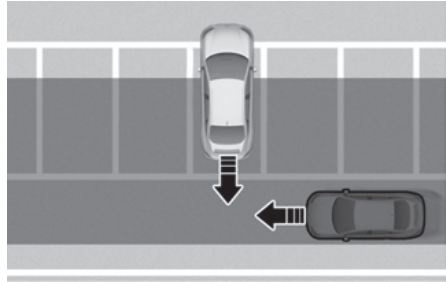

Rear Cross-Traffic Collision-Avoidance Assist may detect vehicles passing by behind you when parking in reverse into a parking space. If this occurs, the function may unnecessarily warn the driver and control the brake.

Always check your surroundings while backing up.

WARNING

- When you are towing a trailer or turn off Rear Cross-Traffic Collision-Avoidance Assist for safety reasons.
- Rear Cross-Traffic Collision-Avoidance Assist may not operate properly if interfered by strong electromagnetic waves.
- Rear Cross-Traffic Collision-Avoidance Assist may not operate for 3 seconds after the vehicle is started, or the rear corner radars are initialized.

Forward/Reverse Parking Distance Warning (PDW)

+ if equipped

Forward/Reverse Parking Distance Warning can help warn the driver if an obstacle is detected within a certain distance when the vehicle is moving forward or in reverse at low speeds.

Detecting sensor

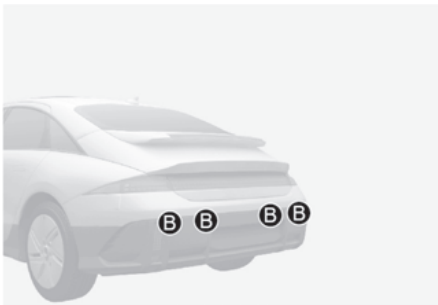

[A] Front ultrasonic sensors,
[B] Rear ultrasonic sensors

Refer to the picture above for the detailed location of the detecting sensors.

Forward/Reverse Parking Distance Warning settings

Warning Methods

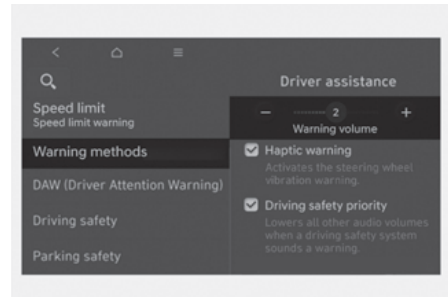

With the vehicle on, go to **Setup > Vehicle > Driver assistance > Warning methods (select speaker icon)** from the Settings in the infotainment system to select the following:

- **Warning volume:** The Warning volume can be adjusted.

If you turn off the Warning Volume, for your safety, the function may warn you with a low volume.

i Information

- If you change the Warning methods, Warning methods of other Driver Assistance systems may change.
- If the vehicle is restarted, Warning methods will maintain the last setting.
- There may be no Settings menu depending on the feature applied to your vehicle.

Parking Distance Warning Auto On

To use Parking Distance Warning Auto On function, select **Setup (Settings) > Vehicle > Driver assistance > Parking safety > Parking Distance Warning Auto On** from the infotainment system settings menu.

i Information

When Parking Distance Warning Auto On is selected, the Parking Safety button indicator (P_{sw}) stays on.

Forward/Reverse Parking Distance Warning operation

Parking Safety button



Press the Parking Safety (P_{sw}) button to turn on Forward/Reverse Parking Distance Warning. Press the button again to turn off the function.

- When the gear is shift to R (Reverse), Parking Distance Warning will automatically turn on (Parking Safety button indicator on).

Forward Parking Distance Warning



Forward Parking Distance Warning will operate when one of the condition is satisfied.

- The gear is shifted from R (Reverse) to D (Drive) with Reverse Parking Distance Warning on
- The gear is in D (Drive) and the Parking Safety button indicator light is on
- Shift to D (Drive) when the function is off (Only when **Setup (Settings) > Vehicle > Driver assistance > Parking safety > Parking Distance Warning Auto On** is selected from the infotainment system settings menu.)
- The gear is shifted to R (only front corner warning is on)

i Information

- Forward Parking Distance Warning will operate only when the vehicle's forward speed is below 10 km/h (6 mph).
- Forward Parking Distance Warning is deactivated if the vehicle speed reaches above 30 km/h (18 mph). It will not reactivate although the vehicle speed drops below 10 km/h (6 mph).
- Only the front outer ultrasonic sensor will operate when the gear is in R (Reverse).

(Only when **Setup (Settings) > Vehicle > Driver assistance > Parking safety > Parking Distance Warning Auto On** is not selected from the infotainment system settings menu.)

Distance from object	Warning indicator	Warning sound
60-100 cm (24-40 in.)		Buzzer beeps intermittently
30-60 cm (12-24 in.)		Beeps more frequently
within 30 cm (12 in.)		Beeps continuously

- The corresponding indicator will illuminate whenever each ultrasonic sensor detects a person, animal or object in its sensing range. Also an audible warning will sound.
- When more than two objects are detected at the same time, the closest one will be warned with an audible warning.
- The shape of the indicator in the illustration may differ from the actual vehicle.



Reverse Parking Distance Warning

Reverse Parking Distance Warning will operate under the following conditions.

- The gear is shifted to R (Reverse).

i Information

Reverse Parking Distance Warning will operate when the vehicle's reverse speed is below 10 km/h (6 mph).

Distance from object	Warning indicator	Warning sound
60-120 cm (24-48 in.)		Buzzer beeps intermittently
30-60 cm (12-24 in.)		Beeps more frequently
within 30 cm (12 in.)		Beeps continuously

- The corresponding indicator will illuminate whenever each ultrasonic sensor detects a person, animal or object in its sensing range. Also an audible warning will sound.
- When more than two objects are detected at the same time, the closest one will be warned with an audible warning.
- The shape of the indicator in the illustration may differ from the actual vehicle.

Forward/Reverse Parking Distance Warning malfunction and limitations

Parking Distance Warning malfunction

After starting the vehicle, a beep will sound when the gear is shifted to R (Reverse) to indicate Parking Distance Warning is operating properly.

However, if one or more of the following occurs, first check whether the ultrasonic sensor is damaged or blocked with foreign material. If it still does not work properly, we recommend that you have the vehicle inspected by an authorized HYUNDAI dealer.

- The audible warning does not sound.
- The buzzer sounds intermittently.
- The '**Ultrasonic sensor error or blockage**' warning message appears on the instrument cluster.

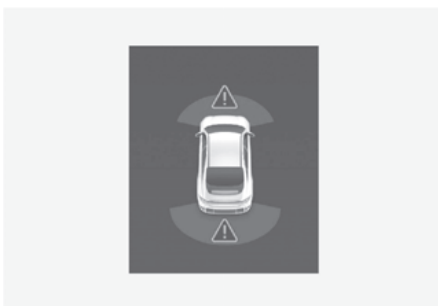
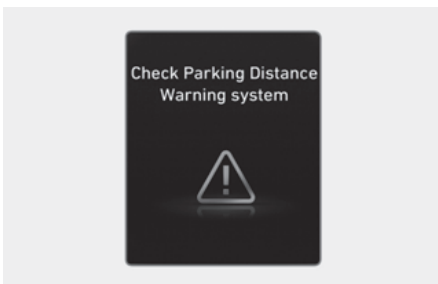

Parking Distance Warning disabled

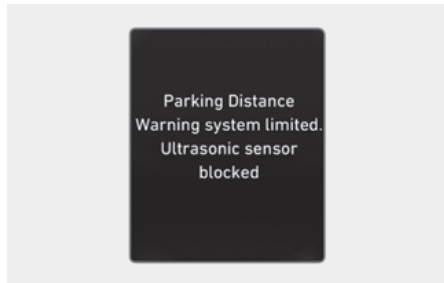

If this occurs the '**Parking Distance Warning system limited. Ultrasonic sensor blocked**' warning message appears on the instrument cluster. Parking Distance Warning will operate properly when snow, rain or foreign material is removed.

If Parking Distance Warning does not operate properly after obstruction (snow, rain, or foreign material) is removed (including trailer, carrier, etc., from the rear bumper), we recommend that you have the vehicle inspected by an authorized HYUNDAI dealer.

Limitations of Forward/Reverse Parking Distance Warning

- Parking Distance Warning may not operate properly when:
 - Moisture is frozen to the sensor
 - Sensor is covered with substance, such as snow or water (Forward/Reverse Parking Distance Warning will operate properly when such substance is removed.)
 - The weather is extremely hot or cold
 - The sensor or sensor assembly is disassembled
 - The surface of the sensor is pressed hard or hit with a hard object
 - The surface of the sensor is scratched with a sharp object
 - The sensors or its surrounding area is directly sprayed with high pressure washer
- Parking Distance Warning may malfunction when:
 - Heavy rain or water spray is present
 - Water flows on the surface of the sensor
 - Affected by another vehicle's sensors
 - The sensor is covered with snow or ice
 - Driving on uneven road, gravel roads or bushes
 - Objects that generates ultrasonic waves are near the sensor
 - License plate is installed in a different spot from the original location
 - The vehicle bumper height or ultrasonic sensor installation has been modified
 - Attaching equipment or accessories next to the ultrasonic sensors
- The following objects may not be detected:
 - Sharp or slim objects, such as ropes, chains or small poles.
 - Narrow objects, such as corners of a square column
 - Objects, which tend to absorb sensor frequency, such as clothes, spongy material or snow.
 - Objects smaller than 100 cm (40 in.) in length and narrower than 14 cm (6 in.) in diameter.
 - Pedestrians, animals or objects that are very close to the ultrasonic sensors

WARNING

- Parking Distance Warning is a supplemental function. The operation of Parking Distance Warning can be affected by several factors (including environmental conditions). It is the responsibility of the driver to always check the front and rear views before and while parking.
- Your new vehicle warranty does not cover any accidents or damage to the vehicle due to the malfunction of Parking Distance Warning.
- Pay close attention when driving near objects, pedestrians, and especially children. Some objects may not be detected by the ultrasonic sensors, due to the objects distance, size or material, all of which can limit the effectiveness of the sensor.
- Parking Distance Warning does not warn you in the order of detection. It varies depending on the speed of the vehicle or the shape of a person, animal, or object.
- If the Parking Distance Warning does not operate properly, we recommend that you have the vehicle inspected by an authorized HYUNDAI dealer.

Forward/Side/Reverse Parking Distance Warning (PDW)

+ If equipped

Forward/Side/Reverse Parking Distance Warning uses the front, side, and rear ultrasonic sensors to detect and warns you if a person, animal, or object is within a certain distance when your vehicle is stopped or driving at low speed.

Detecting sensor

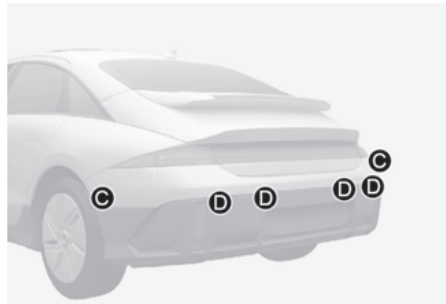
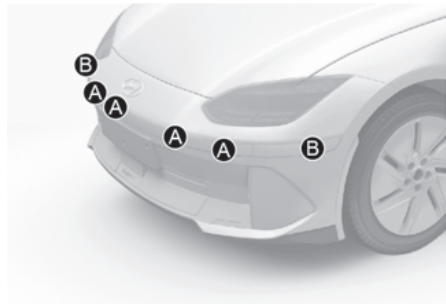

- [A] Front ultrasonic sensors
- [B] Front side ultrasonic sensors
- [C] Rear side ultrasonic sensors
- [D] Rear ultrasonic sensors

Refer to the picture above for the detailed location of the detecting sensors.

Parking Distance Warning Settings

Warning Methods

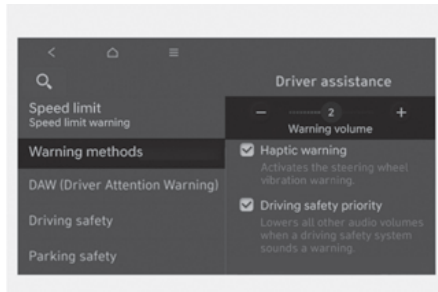

With the vehicle on, go to **Setup > Vehicle > Driver assistance > Warning methods (select speaker icon)** from the Settings in the infotainment system to select the following:

- **Warning volume:** The Warning volume can be adjusted.

If you turn off the Warning Volume, for your safety, the function may warn you with a low volume.

i Information

- If you change the Warning methods, Warning methods of other Driver Assistance systems may change.
- If the vehicle is restarted, Warning methods will maintain the last setting.
- There may be no Settings menu depending on the feature applied to your vehicle.

Parking Distance Warning Auto On

To use Parking Distance Warning Auto On function, select **Setup (Settings) > Vehicle > Driver assistance > Parking safety > Parking Distance Warning Auto On** from the infotainment system settings menu.

i Information

- When Parking Distance Warning Auto On is selected, the Parking Safety button indicator (P_W) stays on.

Parking Distance Warning Operation

Parking Safety button



Press the Parking Safety (P_W) button to turn on Forward/Reverse Parking Distance Warning. Press the button again to turn off the function.

- When the gear is shift to R (Reverse), Parking Distance Warning will automatically turn on (Parking Safety button indicator on).



Forward Parking Distance Warning

Forward Parking Distance Warning will operate under the following conditions.

- The gear is shifted from R (Reverse) to D (Drive) with Reverse Parking Distance Warning on
- The gear is in D (Drive) and the Parking Safety (P_S) button indicator light is on
- Shift to D (Drive) when the function is off
(Only when **Setup (Settings) > Vehicle > Driver assistance > Parking safety > Parking Distance Warning Auto On** is selected from the infotainment system settings menu.)
- Shift to "R" (Reverse) (only front corner warning is on)

i Information

- Forward Parking Distance Warning will operate only when the vehicle's forward speed is below 10 km/h (6 mph).
- Forward Parking Distance Warning is deactivated if the vehicle speed reaches above 30 km/h (18 mph). It will not reactivate although the vehicle speed drops below 10 km/h (6 mph).
- Only the front outer ultrasonic sensor will operate when the gear is in R (Reverse).
- (Only when **Setup (Settings) > Vehicle > Driver assistance > Parking safety > Parking Distance Warning Auto On** is not selected from the infotainment system settings menu.)

Distance from object	Warning indicator	Warning sound
60-100 cm (24-40 in.)		Buzzer beeps intermittently
30-60 cm (12-24 in.)		Beeps more frequently
30 cm (within 12 in.)		Beeps continuously

- The corresponding indicator will illuminate whenever each ultrasonic sensor detects a person, animal or object in its sensing range. Also an audible warning will sound.
- When more than two objects are detected at the same time, the closest one will be warned with an audible warning.
- The shape of the indicator in the illustration may differ from the actual vehicle.



Side Parking Distance Warning

Side Parking Distance Warning will operate under the following conditions.

- The gear is shifted to R (Reverse).
- The gear is shifted from R (Reverse) to D (Drive).
- The gear is in D (Drive) and the Parking Safety (P) button indicator light is on
- Shift to D (Drive) when the function is off
(Only when **Setup (Settings) > Vehicle > Driver assistance > Parking safety > Parking Distance Warning Auto On** is selected from the infotainment system settings menu.)

i Information

- Side Parking Distance Warning will operate when the vehicle's forward speed is below 10 km/h (6 mph).
- Side Parking Distance Warning operated only when Forward or Rearward Parking Distance Warning is on.

Distance from object	Warning indicator	Warning sound
60-100 cm (24-40 in.)		-
30-60 cm (12-24 in.)		-
30 cm (within 12 in.)		Beeps continuously

- The corresponding indicator will illuminate whenever each ultrasonic sensor detects a person, animal or object in its sensing range.
- If an object located within 30 cm (12 in.) from the side of the vehicle's path is detected, an audible warning will sound.
- If an object outside the side of the vehicle's path is detected, the warning indicator will be displayed.
- The shape of the indicator in the illustration may differ from the actual vehicle.

Reverse/Side Parking Distance Warning



Reverse/Side Parking Distance Warning will operate under the following conditions.

- The gear is shifted to R (Reverse).

i Information

Side Parking Distance Warning operated only when Forward or Rearward Parking Distance Warning is on.

- The corresponding indicator will illuminate whenever each ultrasonic sensor detects a person, animal or object in its sensing range. Also an audible warning will sound.
- When more than two objects are detected at the same time, the closest one will be warned with an audible warning.
- The shape of the indicator in the illustration may differ from the actual vehicle.

Distance from object	Warning indicator	Warning sound
60-120 cm (24-48 in.) (Corner: 60-100 cm (24-40 in.))		Buzzer beeps intermittently
30-60 cm (12-24 in.)		Beeps more frequently
30 cm (within 12 in.)		Beeps continuously

Parking Distance Warning Malfunction and Limitations

Parking Distance Warning malfunction

After starting the vehicle, a beep will sound when the gear is shifted to R (Reverse) to indicate Parking Distance Warning is operating properly.

However, if one or more of the following occurs, first check whether the ultrasonic sensor is damaged or blocked with foreign material. If it still does not work properly, have the vehicle inspected by an authorized HYUNDAI dealer.

- The audible warning does not sound.
- The buzzer sounds intermittently.

- The '**Check Parking Distance Warning system**' warning message appears on the instrument cluster.

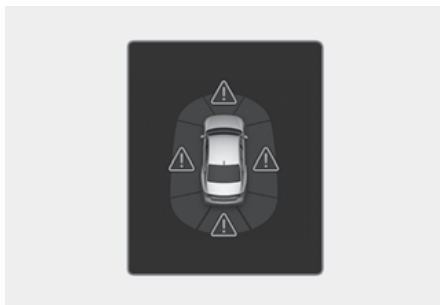
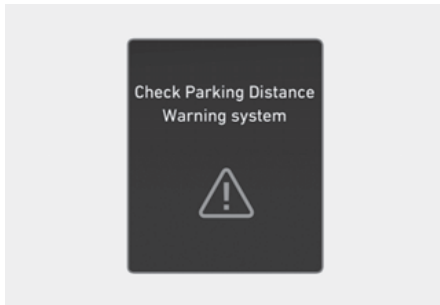

Parking Distance Warning disabled

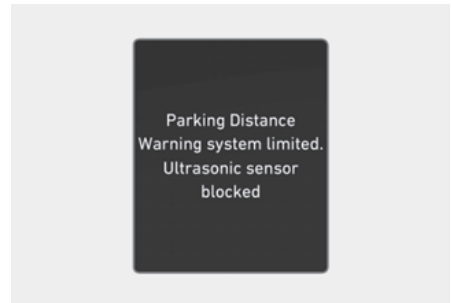

If this occurs the '**Parking Distance Warning system limited. Ultrasonic sensor blocked**' warning message appears on the instrument cluster. Parking Distance Warning will operate properly when snow, rain or foreign material is removed. If Parking Distance Warning does not operate properly after obstruction (snow, rain, or foreign material) is removed (including trailer, carrier, etc., from the rear bumper), have the vehicle inspected by an authorized HYUNDAI dealer.

Limitations of Parking Distance Warning

- Parking Distance Warning may not operate properly when:
 - There is excessive moisture or frost on the sensor
 - Sensor is covered with foreign substance, such as snow or water (Parking Distance Warning will operate properly when such substance is removed.)
 - The weather is extremely hot or cold
 - The sensor or sensor assembly is disassembled
 - The surface of the sensor is pressed hard or hit with a hard object
 - The surface of the sensor is scratched with a sharp object
 - The sensors or its surrounding area is directly sprayed with high pressure washer
- Parking Distance Warning may malfunction when:
 - Heavy rain or water spray is present
 - Water flows on the surface of the sensor
 - Affected by another vehicle's sensors
 - The sensor is covered with snow or ice
 - Driving on uneven road, gravel roads or bushes
 - Objects that generates ultrasonic waves are near the sensor
 - License plate is installed in a different spot from the original location
 - The vehicle bumper height or ultrasonic sensor installation has been modified
 - Attaching equipment or accessories next to the ultrasonic sensors
- The following objects may not be detected:
 - Sharp or slim objects, such as ropes, chains or small poles.
 - Narrow objects, such as corners of a square column
 - Objects, which tend to absorb sensor frequency, such as clothes, spongy material or snow.
 - Objects smaller than 100 cm (40 in.) in length and narrower than 14 cm (6 in.) in diameter.
 - Pedestrians, animals or objects that are very close to the ultrasonic sensors
 - An object in the side space between the front corner ultrasonic sensor and the rear corner ultrasonic sensor or an object approaching the side space

WARNING

- Parking Distance Warning is a supplemental function. The operation of Parking Distance Warning can be affected by several factors (including environmental conditions). It is the responsibility of the driver to always check the front and rear views before and while parking.
- Your new vehicle warranty does not cover any accidents or damage to the vehicle due to the malfunction of Parking Distance Warning.

- Pay close attention when driving near objects, pedestrians, and especially children. Some objects may not be detected by the ultrasonic sensors, due to the objects distance, size or material, all of which can limit the effectiveness of the sensor.
 - Parking Distance Warning does not warn you in the order of detection. It varies depending on the speed of the vehicle or the shape of a person, animal, or object.
 - If the Parking Distance Warning does not operate properly, we recommend that you have the vehicle inspected by an authorized HYUNDAI dealer.
-

Reverse Parking Collision-Avoidance Assist (PCA)

 if equipped

Reverse Parking Collision-Avoidance Assist detects pedestrians or objects behind the vehicle and may warn you or assist you with braking to help avoid a collision while your vehicle is reversing.

Detecting sensor

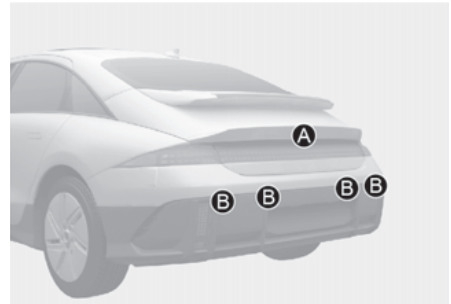

[A] Wide-rear view camera,
[B] Rear ultrasonic sensors

Refer to the picture above for the detailed location of the detecting sensors.

Reverse Parking Collision-Avoidance Assist settings

Parking Safety

With the vehicle on, select or deselect **Setup (Settings) > Vehicle > Driver Assistance > Parking Safety** from the Settings menu to set whether to use each function.

- If "Rear Safety" is selected, Reverse Parking Collision-Avoidance Assist will warn the driver and assist with braking when a collision with a pedestrian or an object is imminent from behind.

i Information

If the vehicle is restarted, 'Rear Safety' will maintain the last setting

Warning Methods

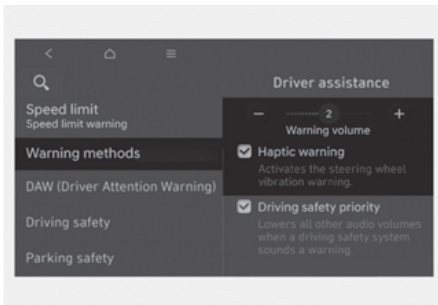

With the vehicle on, go to **Setup > Vehicle > Driver assistance > Warning methods (select speaker icon)** from the Settings in the infotainment system to select the following:

- **Warning volume:** The Warning volume can be adjusted.
If you turn off the Warning Volume, for your safety, the function may warn you with a low volume.
- **Haptic warning:** The steering wheel vibration can be set. (if equipped)

i Information

- If you change the Warning methods, Warning methods of other Driver Assistance systems may change.
- If the vehicle is restarted, Warning methods will maintain the last setting.
- There may be no settings menu depending on the feature applied to your vehicle.
- The Warning Volume and Haptic Warning cannot be turned off at the same time. When one of the warning is turned off the other is activated.

Reverse Parking Collision-Avoidance Assist operation



Turning Reverse Parking Collision Avoidance Assist On/Off

Press and hold the Parking Safety (PVA) button more than 2 seconds to turn the Reverse Parking Collision-Avoidance Assist on or off.

Operating conditions

If Reverse Parking Collision-Avoidance Assist detects a risk of collision behind the vehicle with a pedestrian or an object, Reverse Parking Collision-Avoidance Assist will warn the driver with an audible warning and warning message on the instrument cluster. If Surround View Monitor is operating, a warning will appear on the infotainment screen.

If collision is imminent, Reverse Parking Collision-Avoidance Assist will assist you with braking.

Select **Parking safety** > **Rear safety** from the settings menu.

Reverse Parking Collision-Avoidance Assist is enabled when the following conditions are satisfied:

- The trunk and door are closed
- The Electronic Parking Brake (EPB) is released
- A trailer is not connected
- The gear is shifted to R (Reverse)
- Vehicle speed is below 10 km/h (6 mph) (detecting pedestrians)
- Vehicle speed is below 4 km/h (2.4 mph) (detecting objects)
- Reverse Parking Collision-Avoidance Assist components such as the rear view camera and the rear ultrasonic sensors are in normal conditions

When Reverse Parking Collision-Avoidance Assist activates, a line appears behind the vehicle image in the instrument cluster.



i Information

Reverse Parking Collision-Avoidance Assist operates only once after shifting the gear to R (Reverse) or D (Drive). To reactivate Reverse Parking Collision-Avoidance Assist, shift the gear from another gear to R (Reverse) or D (Drive).

Off conditions

If collision is imminent, Reverse Parking Collision-Avoidance Assist will assist you with braking.

Braking assist is released after 5 minutes. Immediately depress the brake pedal and check vehicle surroundings.

Braking assist is also released in the following conditions when:

- The gear is shifted to P (Park) or D (Drive)
- The brake pedal is depressed with sufficient power

i Information

When Reverse Parking Collision-Avoidance Assist is activated while reversing, braking control will be released after 5 minutes and the Electronic Parking Brake (EPB) will be engaged.

Reverse Parking Collision-Avoidance Assist malfunction and limitations

Reverse Parking Collision-Avoidance Assist malfunction



When Reverse Parking Collision-Avoidance Assist or other related functions are not working properly, the '**Check Reverse Parking Collision-Avoidance Assist system**' warning message will appear on the instrument cluster, and Reverse Parking Collision-Avoidance Assist will turn off automatically. We recommend that you have the vehicle inspected by an authorized HYUNDAI dealer.

Reverse Parking Collision-Avoidance Assist disabled

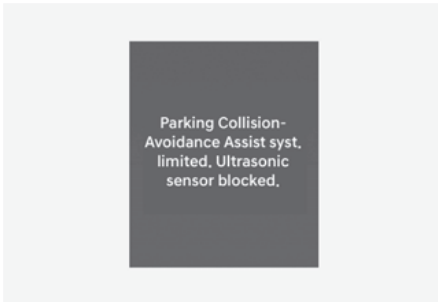
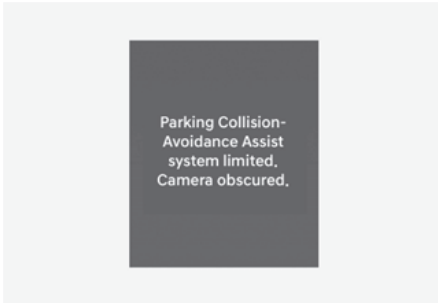

The '**Parking Collision-Avoidance Assist system limited. Camera obscured**' or '**Parking Collision-Avoidance Assist syst. limited. Ultrasonic sensor blocked**' warning message will appear on the instrument cluster if the following situations occur:

- The camera(s) or ultrasonic sensor(s) is covered with foreign material, such as snow or rain, etc.
- There is inclement weather, such as heavy snow, heavy rain, etc.

If this occurs, Reverse Parking Collision-Avoidance Assist may turn off or may not operate properly. Check whether the cameras and ultrasonic sensors are clean.

Limitations of Reverse Parking Collision-Avoidance Assist

Reverse Parking Collision-Avoidance Assist may not assist braking or warn the driver even if there are pedestrians or objects under the following circumstances:

- Problems with vehicle
 - Any non-factory equipment or accessory is installed
 - Your vehicle is unstable due to an accident or other causes
 - Bumper height or rear ultrasonic sensor installation has been modified
 - Wide-rear view camera(s) or ultrasonic sensor(s) is damaged
 - Wide-rear view camera(s) or the ultrasonic sensor(s) is stained with foreign material, such as snow, dirt, etc.
 - Your vehicle height is low or high due to heavy loads, abnormal tire pressure, etc.
 - Wide-rear view camera(s) is obscured by a light source or by inclement weather, such as heavy rain, fog, snow, etc.

- Problems with the surroundings
 - The surrounding is very bright or very dark
 - Outside temperature is very high or very low
 - The wind is either strong (above 20 km/h (12 mph)) or blowing perpendicular to the rear bumper
 - Objects generating excessive noise, such as vehicle horns, loud motorcycle vehicles or truck air brakes, are near your vehicle
 - An ultrasonic sensor with similar frequency is near your vehicle
 - The road is slippery or inclined
 - The image of the pedestrian in the front view camera is indistinguishable from the background
 - Problems with pedestrian or object
 - The pedestrians are difficult to detect
 - There is ground height difference between the vehicle and the pedestrian
 - The pedestrian is near the rear edge of the vehicle
 - The pedestrian is not standing upright
 - The pedestrian is either very short or very tall to detect
 - The pedestrian or cyclist is wearing clothing that easily blends into the background, making it difficult to detect
 - The pedestrian is wearing clothing that does not reflect ultrasonic waves well
 - Size, thickness, height, or shape of the object does not reflect ultrasonic waves well (for example, low object, narrow object, circular pillar, small pillar, corners of a square pillar, bush, curbs, carts, edge of a wall, etc.)
 - The pedestrian or the object is moving
 - The pedestrian or the object is very close to the rear of the vehicle
 - There is a large object such as a wall is behind the pedestrian or the object
 - The object is not located at the front or rear center of your vehicle
 - The object is not parallel to the rear bumper
 - The sensors cannot detect the pedestrians and objects
- Problems with driving condition
 - The driver drives the vehicle immediately after shifting to R (Reverse) or D (Drive)
 - The driver accelerates or circles the vehicle
 - The vehicle is driven immediately after starting the vehicle

WARNING

Take the following precautions when using Reverse Parking Collision-Avoidance Assist:

- Always exercise extreme caution while driving. The driver is responsible for braking and safe driving.
- Always pay attention to road and traffic conditions while driving, whether or not there is a warning.
- Always look around your vehicle to make sure there are no pedestrians or objects before moving the vehicle.
- The performance of Reverse Parking Collision-Avoidance Assist may vary under certain conditions. If vehicle speed is above 4 km/h (2 mph), Reverse Parking Collision-Avoidance Assist will provide collision avoidance assist only when pedestrians are detected. Always look around and pay attention when driving your vehicle.
- Reverse Parking Collision-Avoidance Assist may operate differently under certain conditions. If the vehicle moves forward and backward repeatedly, Reverse Parking Collision-Avoidance Assist may fail to assist braking or to warn the driver. Always pay attention when driving your vehicle.
- Some objects may not be detected by the rear ultrasonic sensors due to the objects distance, size or material, all of which can limit the effectiveness of the sensor.

- Reverse Parking Collision-Avoidance Assist may not operate properly or may operate unnecessarily depending on the road conditions and the surroundings.
- Do not solely rely on Reverse Parking Collision-Avoidance Assist. Doing so may lead to vehicle damage or injuries.

CAUTION

- Noise may be heard when sudden braking occurs to avoid a collision.
- If any other warning sound such as the seat belt warning chime is already generated, Reverse Parking Collision-Avoidance Assist warning may not sound.
- Reverse Parking Collision-Avoidance Assist may not work properly if the bumper has been damaged, replaced or repaired.
- Reverse Parking Collision-Avoidance Assist may not operate properly if interfered by strong electromagnetic waves.
- Playing the vehicle audio system at high volume may prevent passengers from hearing Reverse Parking Collision-Avoidance Assist warning sounds.
- Turn off Reverse Parking Collision-Avoidance Assist when towing a trailer. If towing and moving in reverse, Reverse Parking Collision-Avoidance Assist will activate as it detects the trailer.

- The brake control may not operate properly depending on the status of ESC (Electronic Stability Control).

There will only be a warning when:

- The ESC (Electronic Stability Control) warning light is on
 - ESC (Electronic Stability Control) is engaged in a different function
-

CAUTION

Take the following precautions to maintain optimal performance of the detecting sensors:

- Always keep the wide-rear view cameras and ultrasonic sensors clean.
- Do not use any cleanser containing acid or alkaline detergents when cleaning the camera lens. Use only a mild soap or neutral detergent, and rinse thoroughly with water.
- Do not spray the wide-rear view cameras or the rear ultrasonic sensors or their surrounding area directly with a high pressure washer. It may cause the wide angle cameras or the ultrasonic sensors to malfunction.
- Do not apply objects, such as a bumper sticker or a bumper guard, near the wide angle cameras or ultrasonic sensors or apply paint to the bumper. Doing so may adversely affect the performance of Reverse Parking Collision-Avoidance Assist.

- Never disassemble or apply impact on the wide angle cameras or the ultrasonic sensors components.
 - Do not apply unnecessary force on the wide-rear view cameras or the ultrasonic sensors. Reverse Parking Collision-Avoidance Assist may not operate properly if the wide angle cameras or the ultrasonic sensor(s) is forcibly moved out of proper alignment. We recommend that you have the vehicle inspected by an authorized HYUNDAI dealer.
-

Information

Reverse Parking Collision-Avoidance Assist can detect a pedestrian or an object when:

- A pedestrian is standing behind the vehicle
 - A large obstacle, such as a vehicle, is parked in the rear center of your vehicle
-

Forward/Side/Reverse Parking Collision-Avoidance Assist (PCA)

+ if equipped

Forward/Side/Reverse Parking Collision-Avoidance Assist detects pedestrians or objects and may warn you or assist you with braking to help avoid a collision while driving at low speed.

Detecting sensor

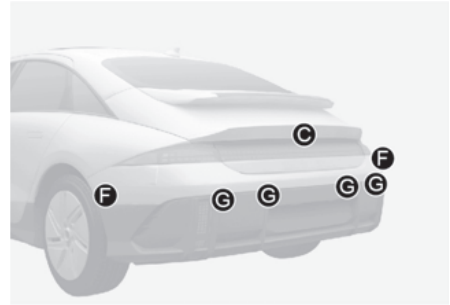
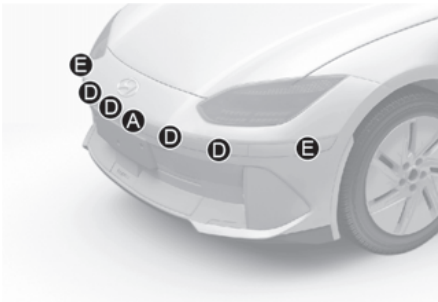
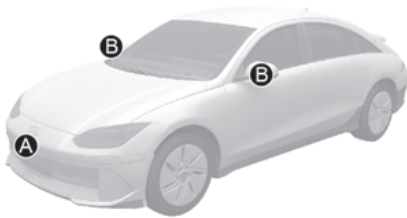

- [A] Wide-front view camera
- [B] Wide-side view camera (below the outside mirror)
- [C] Wide-rear view camera
- [D] Front ultrasonic sensors
- [E] Front side ultrasonic sensors
- [F] Rear side ultrasonic sensors
- [G] Rear ultrasonic sensors

Refer to the picture above for the detailed location of the detecting sensors.

Parking Collision-Avoidance Assist settings

Parking Safety

With the vehicle on, select or deselect **Setup (Settings) > Vehicle > Driver Assistance > Parking Safety** from the Settings menu to set whether to use each function.

- If 'Front/Side Safety' is selected, Parking Collision-Avoidance Assist will warn the driver and assist with braking when a collision with a pedestrian or an object is imminent from the front or the side.

- If 'Rear Safety' is selected, Parking Collision-Avoidance Assist will warn the driver and assist with braking when a collision with a pedestrian or an object is imminent from behind.

i Information

'Forward/Side Safety' can be selected only when 'Rear Safety' is selected. If the vehicle is restarted, 'Rear Safety' is selected and 'Forward/Side safety' maintains the last setting.

Warning Methods

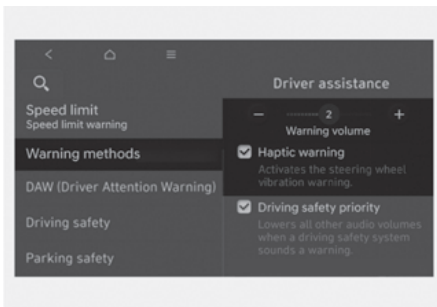

With the vehicle on, go to **Setup > Vehicle > Driver assistance > Warning methods (select speaker icon)** from the Settings in the infotainment system to select the following:

- **Warning volume:** The warning volume can be adjusted.
If you turn off the Warning Volume, for your safety, the function may warn you with a low volume.
- **Haptic warning:** The steering wheel vibration can be set.(if equipped)
- **Driving safety priority:** Your vehicle lowers all other audio volumes when the Driver Assistance system warning sounds.

i Information

- If the vehicle is restarted, warning volume will maintain the last setting.
 - If the vehicle is restarted, warning methods will maintain the last setting.
 - There may be no Settings menu depending on the feature applied to your vehicle.
 - The Warning Volume and Haptic Warning cannot be turned off at the same time. When one of the warning is turned off the other is activated.
-

Parking Collision-Avoidance Assist operation



Turning Parking Collision Avoidance Assist On/Off

Press and hold the Parking Safety (PWA) button more than 2 seconds to turn the Parking Collision-Avoidance Assist on or off.

Operating conditions

If Parking Collision-Avoidance Assist detects a risk of collision behind the vehicle with a pedestrian or an object, Parking Collision-Avoidance Assist will warn the driver with an audible warning and warning message on the instrument cluster. If Surround View Monitor is operating, a warning will appear on the infotainment screen.

If collision is imminent, Parking Collision-Avoidance Assist will assist you with braking.

Select **Parking safety** > **Rear safety** from the settings menu.

Parking Collision-Avoidance Assist is enabled when the following conditions are satisfied:

Rear Safety

- The trunk and door are closed
- The Electronic Parking Brake (EPB) is released
- A trailer is not connected
- The gear is shifted to R (Reverse)
- Vehicle speed is below 10 km/h (6 mph) (detecting pedestrians)
- Vehicle speed is below 4 km/h (2.4 mph) (detecting objects)
- Parking Collision-Avoidance Assist components such as the rear view camera and the rear ultrasonic sensors are in normal conditions

Front/Side Safety

- Front/Side safety is selected from the Parking Safety settings menu in the infotainment system.
- The trunk and door are closed
- The Electronic Parking Brake (EPB) is released
- A trailer is not connected
- The gear is shifted to R (Reverse) or D (Drive)
- Vehicle speed is below 4 km/h (for pedestrians, objects)
- Parking Collision-Avoidance Assist components such as the rear view camera and the rear ultrasonic sensors are in normal conditions

When Parking Collision-Avoidance Assist activates, a line appears behind the vehicle image in the instrument cluster.

- Rear Safety: Behind the vehicle image
- Front/Side Safety: In front of vehicle image



i Information

Parking Collision-Avoidance Assist operates only once after shifting the gear to R (Reverse) or D (Drive). To reactivate Parking Collision-Avoidance Assist, shift the gear from another gear to R (Reverse) or D (Drive).

Off conditions

Front/Side Safety

Braking assist is released 2 seconds after shifting to D (Drive) and 5 minutes after shifting to R (Reverse). Immediately depress the brake pedal and check vehicle surroundings.

Braking assist is also released in the following conditions when:

- The gear is shifted to P (Park) or R (Reverse)
- The brake pedal is depressed with sufficient power

Rear Safety

Braking assist is released after 5 minutes. Immediately depress the brake pedal and check vehicle surroundings.

Braking assist is also released in the following conditions when:

- The gear is shifted to P (Park) or D (Drive)
- The brake pedal is depressed with sufficient power

i Information

When Parking Collision-Avoidance Assist is activated while reversing, braking control will be released after 5 minutes and the Electronic Parking Brake (EPB) will be engaged.

Parking Collision-Avoidance Assist malfunction and limitations

Parking Collision- Avoidance Assist malfunction



When Parking Collision-Avoidance Assist or other related functions are not working properly, the '**Check Parking Collision-Avoidance Assist system**' warning message will appear on the instrument cluster, and Parking Collision-Avoidance Assist will turn off automatically. We recommend that you have the vehicle inspected by an authorized HYUNDAI dealer.

Parking Collision-Avoidance Assist disabled

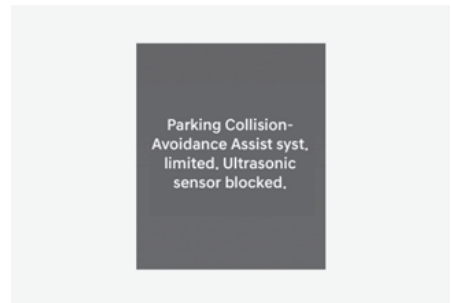
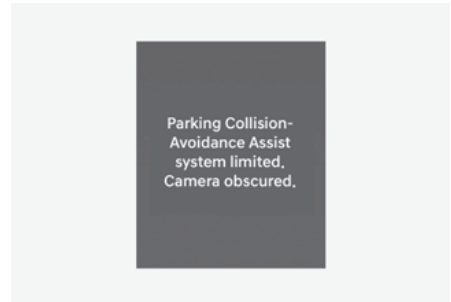

The '**Parking Collision-Avoidance Assist system limited. Camera obscured**' or '**Parking Collision-Avoidance Assist syst. limited. Ultrasonic sensor blocked**' warning message will appear on the instrument cluster if the following situations occur:

- The camera(s) or ultrasonic sensor(s) is covered with foreign material, such as snow or rain, etc.
- There is inclement weather, such as heavy snow, heavy rain, etc.

If this occurs, Parking Collision-Avoidance Assist may turn off or may not operate properly. Check whether the cameras and ultrasonic sensors are clean.

Limitations of Parking Collision-Avoidance Assist

Parking Collision-Avoidance Assist may not assist braking or warn the driver even if there are pedestrians or objects under the following circumstances:

- Problems with vehicle
 - Any non-factory equipment or accessory is installed
 - Your vehicle is unstable due to an accident or other causes
 - Bumper height or rear ultrasonic sensor installation has been modified
 - Wide-rear view camera(s) or ultrasonic sensor(s) is damaged
 - Wide-rear view camera(s) or the ultrasonic sensor(s) is stained with foreign material, such as snow, dirt, etc.
 - Wide-rear view camera(s) is obscured by a light source or by inclement weather, such as heavy rain, fog, snow, etc.
 - Your vehicle height is low or high due to heavy loads, abnormal tire pressure, etc.
- Problems with the surroundings
 - The surrounding is very bright or very dark
 - Outside temperature is very high or very low
 - The wind is either strong (above 20 km/h (12 mph)) or blowing perpendicular to the rear bumper
- Objects generating excessive noise, such as vehicle horns, loud motorcycle vehicles or truck air brakes, are near your vehicle
- An ultrasonic sensor with similar frequency is near your vehicle
- The road is slippery or inclined
- The image of the pedestrian in the front view camera is indistinguishable from the background
- Problems with pedestrian or object
 - The pedestrians are difficult to detect
 - There is ground height difference between the vehicle and the pedestrian
 - The pedestrian is near the rear edge of the vehicle
 - The pedestrian is not standing upright
 - The pedestrian is either very short or very tall to detect
 - The pedestrian or cyclist is wearing clothing that easily blends into the background, making it difficult to detect
 - The pedestrian is wearing clothing that does not reflect ultrasonic waves well
 - Size, thickness, height, or shape of the object does not reflect ultrasonic waves well (for example, low object, narrow object, circular pillar, small pillar, corners of a square pillar, bush, curbs, carts, edge of a wall, etc.)

- The pedestrian or the object is moving
- The pedestrian or the object is very close to the rear of the vehicle
- There is a large object such as a wall is behind the pedestrian or the object
- The object is not located at the front or rear center of your vehicle
- The object is not parallel to the rear bumper
- The sensors cannot detect the pedestrians and objects
- Problems with driving condition
 - The driver drives the vehicle immediately after shifting to R (Reverse) or D (Drive)
 - The driver accelerates or circles the vehicle
 - The vehicle is driven immediately after starting the vehicle
- The performance of Parking Collision-Avoidance Assist may vary under certain conditions. If vehicle speed is above 4 km/h (2 mph), Parking Collision-Avoidance Assist will provide collision avoidance assist only when pedestrians are detected. Always look around and pay attention when driving your vehicle.
- Parking Collision-Avoidance Assist may operate differently under certain conditions. If the vehicle moves forward and backward repeatedly, Parking Collision-Avoidance Assist may fail to assist braking or to warn the driver. Always pay attention when driving your vehicle.
- Some objects may not be detected by the rear ultrasonic sensors due to the objects distance, size or material, all of which can limit the effectiveness of the sensor.
- Parking Collision-Avoidance Assist may not operate properly or may operate unnecessarily depending on the road conditions and the surroundings.
- Do not solely rely on Parking Collision-Avoidance Assist. Doing so may lead to vehicle damage or injuries.

WARNING

Take the following precautions when using Parking Collision-Avoidance Assist:

- Always exercise extreme caution while driving. The driver is responsible for braking and safe driving.
- Always pay attention to road and traffic conditions while driving, whether or not there is a warning.
- Always look around your vehicle to make sure there are no pedestrians or objects before moving the vehicle.

CAUTION

- Noise may be heard when sudden braking occurs to avoid a collision.
- If any other warning sound such as the seat belt warning chime is already generated, Parking Collision-Avoidance Assist warning may not sound.

- Parking Collision-Avoidance Assist may not work properly if the bumper has been damaged, replaced or repaired.
 - Parking Collision-Avoidance Assist may not operate properly if interfered by strong electromagnetic waves.
 - Playing the vehicle audio system at high volume may prevent passengers from hearing Parking Collision-Avoidance Assist warning sounds.
 - Turn off Parking Collision-Avoidance Assist when towing a trailer. If towing and moving in reverse, Parking Collision-Avoidance Assist will activate as it detects the trailer.
 - The brake control may not operate properly depending on the status of ESC (Electronic Stability Control).
There will only be a warning when:
 - The ESC (Electronic Stability Control) warning light is on
 - ESC (Electronic Stability Control) is engaged in a different function
 - Do not spray the wide-rear view cameras or the rear ultrasonic sensors or their surrounding area directly with a high pressure washer. It may cause the wide angle cameras or the ultrasonic sensors to malfunction.
 - Do not apply objects, such as a bumper sticker or a bumper guard, near the wide angle cameras or ultrasonic sensors or apply paint to the bumper. Doing so may adversely affect the performance of Parking Collision-Avoidance Assist.
 - Never disassemble or apply impact on the wide angle cameras or the ultrasonic sensors components.
 - Do not apply unnecessary force on the wide-rear view cameras or the ultrasonic sensors. Parking Collision-Avoidance Assist may not operate properly if the wide angle cameras or the ultrasonic sensor(s) is forcibly moved out of proper alignment. We recommend that you have the vehicle inspected by an authorized HYUNDAI dealer.
-

CAUTION

Take the following precautions to maintain optimal performance of the detecting sensors:

- Always keep the wide-rear view cameras and ultrasonic sensors clean.
- Do not use any cleanser containing acid or alkaline detergents when cleaning the camera lens. Use only a mild soap or neutral detergent, and rinse thoroughly with water.

Information



Parking Collision-Avoidance Assist can detect a pedestrian or an object when:

- A pedestrian is standing behind the vehicle
 - A large obstacle, such as a vehicle, is parked in the rear center of your vehicle
-

Remote Smart Parking Assist 2 (RSPA 2)

 if equipped

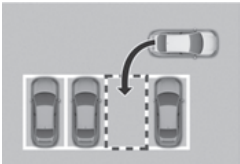
Remote Smart Parking Assist uses the front, front side, rear side, and rear ultrasonic sensors to detect parking spaces and control vehicle steering, speed, gear shifts, and help enter and exit parking spaces remotely from outside your vehicle.

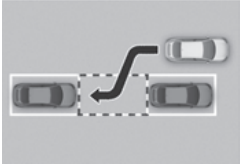
Function	Description
Remote Operation	<p>Remotely moving forward or backward</p> 
Smart Parking or Remote Parking	<p>Perpendicular reverse parking</p> 
	<p>Diagonal reverse parking</p> 
	<p>Parallel reverse parking</p> 

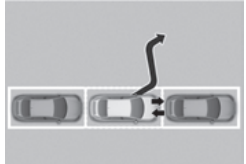
Function	Description
Smart Exit	<p>Parallel forward exit</p> 

- Remote Parking and Remote Operation function may be operated from outside the vehicle using the smart key.
- Smart Parking and Smart Exit function may be operated from inside the vehicle.
- Smart Parking and Remote Parking function helps the driver with perpendicular reverse parking, diagonal reverse parking and parallel reverse parking.
- Smart Exit function helps the driver with parallel forward exit.
- When Remote Smart Parking Assist operates, Parking Distance Warning and Surround View Monitor will also operate. For more information, refer to the "Forward/Reverse Parking Distance Warning (PDW)" and "Surround View Monitor (SVM)" sections in this chapter.
- Remote Smart Parking Assist helps parking by recognizing the parking lines with the wide angle camera.

Detecting sensors

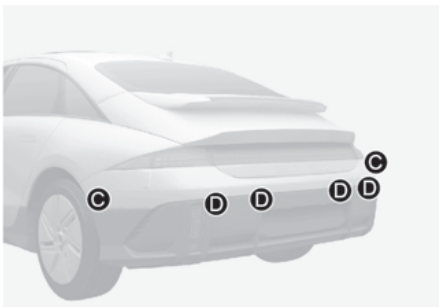
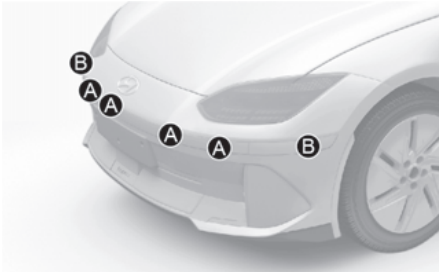

- [A] Front ultrasonic sensors
- [B] Front corner ultrasonic sensors
- [C] Rear corner ultrasonic sensors
- [D] Rear ultrasonic sensors

Refer to the picture above for the detailed location of the detecting sensors.

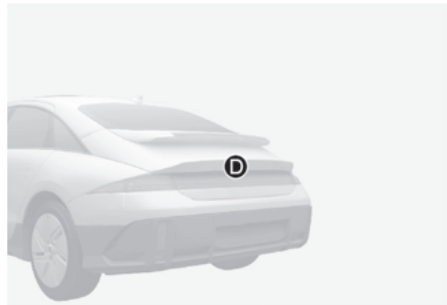
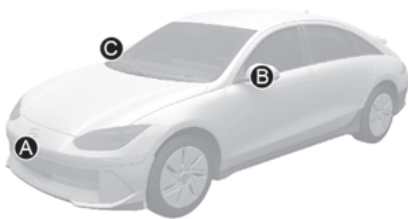

- [A] Wide-front view camera
- [B] Wide-side view camera
- [C] Wide-side view camera
- [D] Wide-rear view camera

Refer to the picture above for the detailed location of the detecting cameras.

CAUTION

Take the following precautions to maintain optimal performance of the detecting sensors:

- Never disassemble the ultrasonic sensor or sensor assembly, or cause any damage to it.
- Remote Smart Parking Assist may malfunction if the vehicle bumper height or ultrasonic sensor installation has been modified or damaged. Any non-factory installed equipment or accessories may also interfere with the sensor performance.
- When the ultrasonic sensor is frozen or stained with snow, dirt, or water, the sensor may not operate until the stains are removed using a soft cloth.

- Do not push, scratch, or strike the ultrasonic sensor. Sensor damage could occur.
- Do not spray the ultrasonic sensors or its surrounding area directly with a high pressure washer.
- Always keep the camera lens clean. If the lens is covered with foreign material, it may adversely affect camera performance and Remote Smart Parking Assist may not operate properly.
- Do not manually adjust the rearview mirror or use Remote Smart Parking Assist after a hard impact on the rearview mirror. When a collision occurs or the outside rearview mirror is manually operated, Remote Smart Parking Assist may not operate properly.

Remote Smart Parking Assist settings

Warning Methods

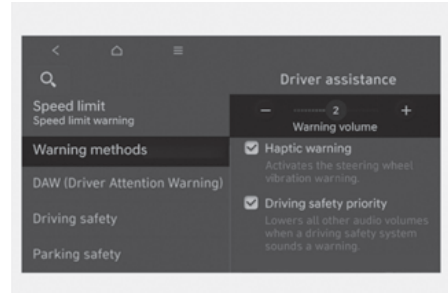

With the vehicle on, go to **Setup > Vehicle > Driver assistance > Warning methods (select speaker icon)** from the Settings in the infotainment system to select the following:

- **Warning volume:** The Warning volume can be adjusted.
If you turn off the Warning Volume, for your safety, the function may warn you with a low volume.





i Information

- If you change the Warning methods, Warning methods of other Driver Assistance systems may change.
- If the vehicle is restarted, Warning methods will maintain the last setting.
- There may be no Settings menu depending on the feature applied to your vehicle.

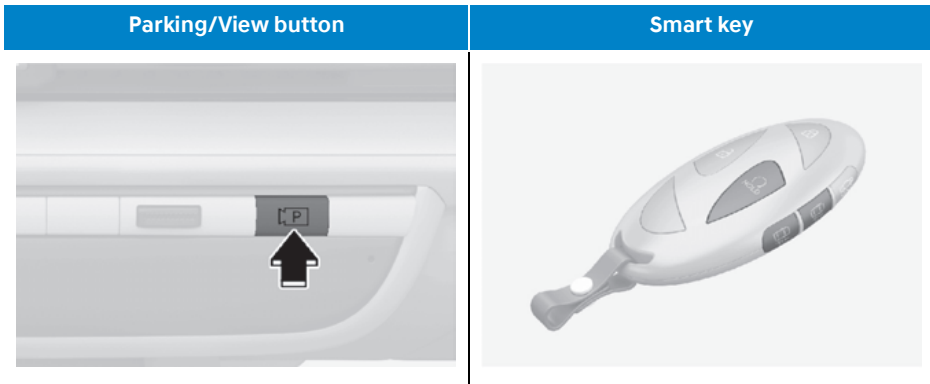
Remote Smart Parking Assist operation

Remote Smart Parking Assist button



Location	Name	Symbol	Description
Inside vehicle	Parking/View button		Press and hold the Parking/View button to turn on Remote Smart Parking Assist. Also, Forward/Reverse Parking Distance warning will automatically turn on. However, functions may differ depending on the situations. Refer to each function's description for more information in the following pages. Press and hold the Parking/View button while Smart Parking or Smart Exit function is on to operate the function.
Smart key	Remote Start button		Press the Remote Start button after the door is locked with the vehicle off to start the vehicle remotely. Press the Remote Start button while Remote Parking or Remote Operation function is operating to end function operation.
	Forward button		When using Remote Parking function, regardless of which direction button is pressed, parking is supported while the button is pressed. When using the Remote Operation function, the vehicle moves in the direction of the button while the button is pressed.
	Backward button		

Remote Operation

Operating order

Remote Operation operates in the following order:

1. Getting ready to remotely move forward and backward
2. Remotely moving forward and backward

1. Getting ready to remotely move forward and backward

There are two ways to operate Remote Operation function.

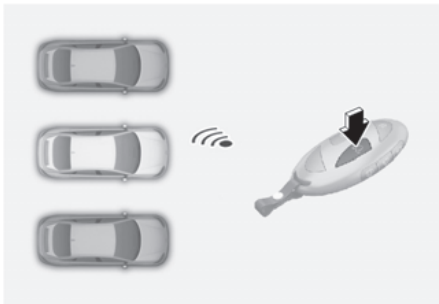

Method 1. Using the function with vehicle off

- Within a certain range from the vehicle press the door lock (🔒) button on the smart key and lock all doors.
- Press and hold the Remote Start button (🔑) within 4 seconds until the vehicle starts.

For more information on remotely starting the vehicle, refer to the "Remote start" section in chapter 6.

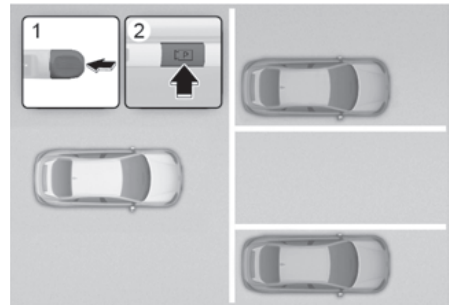

Method 2. Using the function with vehicle on

1. Park the vehicle in front of the space where you want to use Remote Operation function, and shift the gear to P (Park).
2. Press and hold the Parking/View (🔑) button to turn on Smart Parking Assist.
 - A message '**Under Remote Control**' will appear on the infotainment system.

3. Get out of the vehicle with the smart key and close all doors.

i Information

- 'Agree' must be selected on the infotainment system and the infotainment system has to operate properly to use Remote Operation function.
- Method 2 can be used after the vehicle has been driven above 5 km/h (3 mph).
- If the function is turned on again after parking is completed by Remote Smart Parking Assist, Remote Operation function can be used with Method 2.

2. Remotely moving forward and backward

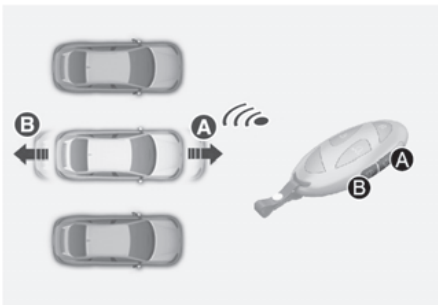

1. Press and hold one of the Forward (⏩) or Backward (⏪) button on the smart key.
 - Remote Smart Parking Assist will automatically control the steering wheel, vehicle speed and gearshift. The vehicle will move in the direction of the button pressed.
2. Hold down the Forward (⏩) or Backward (⏪) button until the vehicle reaches the target location.
3. When Remote Operation is done, get in the vehicle with the smart key or press the Remote Start (🔑) button on the smart key from outside the vehicle.
 - The message will appear on the infotainment system. The vehicle will automatically shift to P (Park) and engage the parking brake.
 - When the Remote Start (🔑) button is pressed, the vehicle will turn off. If the driver is in the vehicle, the vehicle will retain ON position.

i Information

- Remote Operation can control the vehicle remotely using the smart key outside the vehicle.
- Check that all smart keys are outside the vehicle when using Remote Operation function.
- Remote Operation function will operate only when the smart key is within 4 m (13 ft.) from the vehicle. If there is no vehicle movement even when the Forward or Backward button is pressed on the smart key, check the distance to the vehicle and press the button again.
- The detecting range of the smart key may vary depending on the surroundings that are affected by radio waves such as transmission tower, broadcast station, etc.

- When remotely moving forward using Method 1, it is recognized as an exit situation, and the vehicle moves 4 m (13 ft.) to check for parking lines, pedestrians, animals or objects around the vehicle. After confirmation, the steering wheel is controlled according to the condition ahead.
- When remotely moving forward using Method 2, it is recognized as a parking situation, and will immediately control the steering wheel according to the condition ahead to assist with entering the parking space and aligning the vehicle. However, performance may reduce depending on the parking lines, pedestrians, animals, shape of objects, location, etc., around the vehicle.
- For moving remotely backward, both Method 1 and 2 aligns the steering wheel first, and then will only move the vehicle straight.
- After parking, the surrounding may change due to the movement of surrounding vehicles. If this occurs, Remote Operation function may not operate.
- Before leaving the vehicle, close windows and sunroofs, and make sure the vehicle is off before locking the doors.

Remote Operation function operation status

Operation status	Smart key LED	Hazard warning light
Under control	Green LED continuously blinks	-
Pause	Red LED continuously blinks	Blinks
Off	Red LED illuminates for 4 seconds and then turns off	Blinks 3 times and turns off
Complete	Green LED illuminates for 4 seconds and then turns off	Blinks 1 time and turns off

WARNING

- When using Remote Operation function, make sure that all passengers have gotten out of the vehicle.
- If the vehicle's battery is discharged or Remote Smart Parking Assist malfunctions when parked in a narrow parking space, Remote Operation function will not operate. Always park your vehicle in a space wide enough for you to get in or out of your vehicle.
- Please note that depending on the parking space, you may not be able to exit from the space you have entered by using Remote Operation function.

Information

- Operation status by the hazard warning light may not be applicable based on the regulation of your country.
- If the smart key is not within the operating range from the vehicle (about 4 m (13 ft.)), the smart key LED will not illuminate or blink. Use the smart key within the operating range.

How to turn off Remote Operation function while operating

- Press the Parking/View (P) button while the infotainment system guides the driver using method 2.
- Shift the gear from P (Park) to any other position while the infotainment system guides the driver using method 2.
- Press the Parking Safety (P) button or select 'Cancel' on the infotainment system.
- Press the Remote Start (R) button on the smart key while the vehicle is being controlled by Remote Operation function. Remote Operation function will turn off. At this time, the vehicle will turn off.
- Get on the vehicle with the smart key. Remote Operation function will turn off. At this time, the vehicle will remain on.

The function will pause in the following conditions when:

- There is a pedestrian, animal or object in the direction the vehicle is moving
- The door or trunk is open
- The Forward (F) or Backward (B) button is not continuously pressed
- Simultaneously pressing multiple buttons on a smart key
- The smart key is not operated within 4 m (13 ft.) from the vehicle
- Button of another smart key is pressed in addition to the operating smart key (except Remote Start button)

- Parking Collision-Avoidance Assist or Rear Cross-Traffic Collision-Avoidance Assist operates while the vehicle is being controlled in the reverse direction.
- The vehicle moves 7 m (22 ft.) while the smart key is pressed with Remote Operation function (maximum travel distance per button press)

The function will cancel in the following conditions when:

When Remote Operation function is canceled, the vehicle will automatically stop, shift the gear to P (Park) and engage EPB (Electronic Parking Brake).

- The steering wheel is steered
- The gear is shifted while the vehicle is moving
- Operating EPB while the vehicle is moving
- The hood is open
- The brake pedal or accelerator pedal is depressed when all the doors are closed
- The smart key is outside the vehicle when the brake pedal is depressed while the driver's door is open
- Rapid acceleration occurs
- Vehicle skid occurs
- The wheel is stuck by an obstacle and cannot move
- About 3 minutes and 50 seconds has passed after Remote Operation function has started to operate
- The slope of the road exceeds the operational range

- The function is paused for more than 1 minute
- The total travel distance of the vehicle has exceeded 14 m (45 ft.) after Remote Operation function operation
- The steering wheel, gearshift, braking, and drive controls are not working properly
- There is a problem with the smart key or the smart key battery is low
- ABS, TCS or ESC system operates due to slippery road conditions
- The alarm of the Theft Alarm System sounds
- The charging door is open

Smart Parking, Remote Parking

The parking function includes Smart Parking using the Parking/View (P) button and Remote Parking using a smart key.

Operating order

Parking function operates in the following order:

1. Getting ready for parking
2. Searching for parking space
3. Select parking type and operating mode
4. Smart Parking
5. Remote Parking

1. Getting ready for parking



1. With the vehicle turned on, depress the brake pedal and shift the gear to D (Drive) or N (Neutral).
2. Press and hold the Parking/View (P) button to turn on Remote Smart Parking Assist.

i Information

- 'Agree' must be selected on the infotainment system and the infotainment system has to operate properly to use Parking function.
- If you drive above 5 km/h (3 mph) with the vehicle on, you may use the Parking function with the gear shifted to N (Neutral).

2. Searching for parking space



Slowly drive forward maintaining the distance of about 100 cm (40 in.) from the parked vehicles.

Searches for a parking space by detecting the parking lines or the spaces next to or in front and behind the parked vehicles.

When searching for a parking space is complete, a message will appear on the infotainment system with an audible sound to notify the search is complete.

'Select Parking Type' will be displayed on the infotainment system and the selected parking space will appear on Top View screen of Surround View Monitor.

i Information

- Remote Smart Parking Assist can only search for parking spaces when parking lines are visible or when there are parked vehicles, and the empty spaces created after driving or the empty spaces in front of a vehicle that has not yet been driven cannot be searched as the a parking space.

- While searching for a parking space, when vehicle speed is above 20 km/h (12 mph), a message will appear on the infotainment system informing you to slow down. When vehicle speed is above 30 km/h (18 mph), Parking function will turn off.
- Searching for a parking space will be completed when there is enough space to move the vehicle in addition to the parking space.
- Even if an audible sound is heard to notify that searching for a parking space is complete, search completion can be cancelled immediately depending on surroundings.

i Information

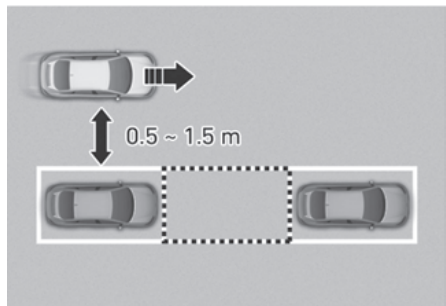

- If the distance is below 50 cm (20 in.) or over 150 cm (59 in.), Remote Smart Parking Assist may not be able to search for a parking space.

- If you do not maintain a certain distance from the parked vehicle, the performance to search for a parking space may reduce.
- Due to abnormal performance of the ultrasonic sensor or the influence of the surroundings, Parking function may not be able to search for a parking space even if there is a parking space, or may search for a space that is not suitable for parking.
- If the parking space is on an incline or is diagonal, the parking type displayed may be different from the actual parking type which should be selected. If this occurs, do not select the parking type, and search for another parking space.

3. Select parking type and operating mode



- Parking type - Perpendicular reverse (Left/Right), Parallel reverse (Left/Right)
- With the vehicle stopped by depressing the brake pedal, touch the infotainment system to select the desired parking type.

i Information

- If you continue to drive without stopping after the parking type selection screen appears, Remote Smart Parking Assist will return to the previous stage and search for a parking space.
- If Parking function is cancelled unintentionally by pressing the Parking/View (P) button before the parking type is selected, you can return to the parking type selection stage by pressing and holding the button again while the vehicle is stopped.

! WARNING

Before selecting the Parking type, the driver should check whether the parking space is suitable.

If the searched parking space by Remote Smart Parking Assist is narrow or unsuitable for parking, do not select the Parking type and move the vehicle to search for another parking space.



- Operating mode - Remote Parking, Smart Parking

After selecting a parking type, the infotainment system will guide you with Remote Parking function and Smart Parking function. Follow the instructions to operate Remote Smart Parking Assist.

i Information

- Operating instructions will be displayed on the screen for each desired function you select.
- Do not take your foot off the brake pedal during the Parking function guide. When the vehicle moves, Remote Smart Parking Assist will turn off.





i Information

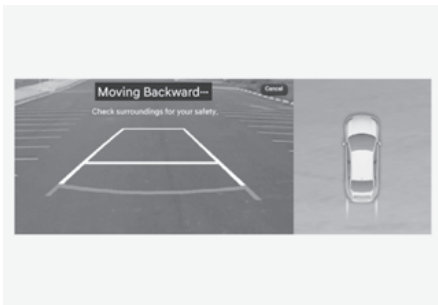

If Remote Smart Parking Assist cannot activate Remote Parking function, only the Smart Parking guide will be displayed on the infotainment system.

4. Smart Parking



1. Press the Parking/View () button when the vehicle is stopped by depressing the brake pedal.
2. Release the brake pedal while pressing the Parking/View () button.
 - Remote Smart Parking Assist will automatically control the steering wheel, vehicle speed and gearshift.
 - While Smart Parking function is operating, if you do not hold down the Parking/View () button, the function will stop and function control will pause. The function will start operating again when the Parking/View () button is pressed and held again.
3. Press and hold the Parking/View () button until parking is completed.
 - When the vehicle reaches the target parking position, a message will appear on the infotainment system to inform you that parking is complete. The vehicle will automatically shift to P (Park) and engage EPB (Electronic Parking Brake).
4. If you need to change the vehicle's position or location, manually complete parking your vehicle.

Information

- Smart Parking function will not operate if the door is open or the seat belt is not fastened.
- The parking location indicator is displayed on Surround View Monitor screen and is displayed until the vehicle enters the parking space for the first time by Smart Parking function.
- Vehicle speed can be adjusted by depressing the brake pedal while Smart Parking function is operating. However, the vehicle does not accelerate even when the accelerator pedal is depressed.
- Depending on parking environments, if the vehicle is stopped by a stopper, parking may be completed.

5. Remote Parking



1. Depress the brake pedal and shift the gear to P (Park).
2. Get out of the vehicle with the smart key, and close all doors.
3. Press one of the Forward (⏪) or Back-ward (⏩) button on the smart key.
 - While pressing the button, Remote Smart Parking Assist will automatically control the steering wheel, vehicle speed and gearshift.
 - While Remote Parking function is operating, if you do not hold down the button, the vehicle will stop and function control will pause. The function will start operating again when the button is pressed and held again.
4. Press and hold the Forward (⏪) or Back-ward (⏩) button until parking is completed.
 - When the vehicle reaches the target parking position, a message will appear on the infotainment system to inform you that parking is complete. The vehicle will automatically shift to P (Park), engage EPB (Electronic Parking Brake) and the vehicle will turn off.

5. If you need to change the vehicle's position or location, manually complete parking your vehicle.

i Information

- When operating Remote Parking function, make sure all smart keys are outside of the vehicle.
- Remote Parking function will operate only when the smart key is within 4 m (13 ft.) from the vehicle. If there is no vehicle movement even when the Remote Forward or Backward button is pressed on the smart key, check the distance to the vehicle and press the button again.
- The detecting range of the smart key may vary depending on the surroundings that are affected by radio waves such as transmission tower, broadcast station, etc.
- The parking location indicator is displayed on Surround View Monitor screen and is displayed until the vehicle enters the parking space for the first time by Remote Parking function.
- Depending on parking environments, if the vehicle is stopped by a stopper, parking may be completed.

! WARNING

- When using Remote Parking function, make sure that all passengers have gotten out of the vehicle.
- After ending or turning off Remote Parking function, before leaving the vehicle, close windows and sunroofs, and make sure the vehicle is off before locking the doors.

Parking function operation status

- Smart Parking function

Operation status	Turn signal
Under control	The turn signal of the parking direction blinks until the first reverse is complete.

- Smart Parking function

Operation status	Smart key LED	Hazard warning light	Turn signal
Under control	Green LED continuously blinks	-	The turn signal of the parking direction blinks until the first reverse is complete.
Pause	Red LED continuously blinks	Blinks	-
Off	Red LED illuminates for 4 seconds and then turns off	Blinks 3 times and turns off	-
Complete	Green LED illuminates for 4 seconds and then turns off	Blinks 1 time and turns off	-

***i* Information**

- Operation status by the hazard warning light and turn signal may not be applicable based on the regulation of your country.
- If the smart key is not within the operating range from the vehicle (about 4m (13 ft.)), the smart key LED will not illuminate or blink. Use the smart key within the operating range.

How to turn off Parking function while operating

- Press the Parking/View (P) button in the following stage:
 - Searching for parking space
 - Select parking type
- Shift the gear to R (Reverse) in the following stage:
 - Searching for parking space
 - Select parking type
 - Select operating mode
- Press the Parking Safety (P) button or select 'Cancel' on the infotainment system to turn off Parking function.
- While Smart Parking function is operating:
 - If the vehicle is stopped by depressing the brake pedal, and the gear is shifted, Parking function will turn off. At this time, EPB (Electronic Parking Brake) will not be engaged.
- While Remote Parking function is operating:
 - Press the Remote Start (R) button on the smart key. Parking function will turn off.

i Information

Get on the vehicle with the smart key. Parking function will turn off. At this time, the vehicle will remain on.

The function will pause in the following conditions when:

- Smart Parking
 - There is a pedestrian, animal or object in the direction the vehicle is moving
 - The door or trunk is open
 - The driver's seat belt is not fastened
 - Parking Collision-Avoidance Assist or Rear-Cross Traffic Collision-Avoidance Assist operates while the vehicle is being controlled in the reverse direction
 - The Parking/View (P) button is not continuously pressed
 - The vehicle is stopped by depressing the brake pedal
- Remote Parking
 - There is a pedestrian, animal or object in the direction the vehicle is moving
 - The door or trunk is open
 - The Forward (F) or Backward (B) button is not continuously pressed
 - Simultaneously pressing multiple buttons on a smart key
 - The smart key is not operated within 4 m (13 ft.) from the vehicle
 - Button of another smart key is pressed in addition to the operating smart key
 - Parking Collision-Avoidance Assist, Rear-Cross Traffic Collision-Avoidance Assist, or Parking Collision-Avoidance Assist operates

When Parking function is paused, the vehicle will automatically stop. If the condition that made the function to pause disappears, the function may operate again.

The function will cancel in the following conditions when:

- Smart Parking
 - The steering wheel is steered
 - The gear is shifted while the vehicle is moving
 - Operating EPB while the vehicle is moving
 - The hood is open
 - The driver opens the door with the seatbelt unfastened
 - Rapid acceleration occurs
 - Vehicle skid occurs
 - The wheel is stuck by an obstacle and cannot move
 - There are pedestrians, animals or objects at the front and rear of the vehicle at the same time
 - About 3 minutes and 50 seconds have past after Smart Parking function has started to operate
 - The slope of the road exceeds the operational range
 - The function is paused for more than 1 minute
 - The steering wheel, gearshift, braking, and drive controls are not working properly
 - ABS, TCS or ESC system operates due to slippery road conditions
 - The charging door is open

When Smart Parking function is cancelled, the vehicle will automatically stop, shift the gear to P (Park) and engage EPB (Electronic Parking Brake).

- Remote Parking
 - The steering wheel is steered
 - The gear is shifted
 - Operating EPB while the vehicle is moving
 - The hood is open
 - The brake pedal or accelerator pedal is depressed when all the doors are closed
 - The smart key is outside the vehicle when the brake pedal is depressed while the driver's door is open
 - Rapid acceleration occurs
 - Vehicle skid occurs
 - The wheel is stuck by an obstacle and cannot move
 - There are pedestrians, animals or objects at the front and rear of the vehicle at the same time
 - About 3 minutes and 50 seconds have past after Remote Parking function has started to operate
 - The slope of the road exceeds the operational range
 - The function is paused for more than 1 minute
 - The steering wheel, gearshift, braking, and drive controls are not working properly
 - There is a problem with the smart key or the smart key battery is low

- ABS, TCS or ESC system operates due to slippery road conditions
- The alarm of the Theft Alarm System sounds
- The charging door is open

When Remote Parking function is cancelled, the vehicle will automatically stop, shift the gear to P (Park) and engage EPB (Electronic Parking Brake).

Smart Exit

Operating order

Smart Exit function operates in the following order:

1. Getting ready for exit
2. Checking space
3. Select exit direction
4. Smart Exit

1. Getting ready for exit



1. With the vehicle turned on, depress the brake pedal and shift the gear to P (Park) or N (Neutral).
2. Press and hold the Parking/View (P) button to turn on Remote Smart Parking Assist.

i Information

- 'Agree' must be selected on the infotainment system and the infotainment system has to operate properly to use Smart Exit function.
- Drive below 5 km/h (3 mph) with the vehicle on and shift the gear to P (Park) or N (Neutral), Smart Exit function can be used.
- If the function is turned on again after parallel parking is completed by Remote Smart Parking Assist, Smart Exit function can be used.

2. Checking space



When the vehicle is stopped by depressing the brake pedal, the vehicle sensors will detect the distance from nearby objects and check for space to exit.

When checking for space is complete, a message will appear on the infotainment system with an audible sound to notify the search is complete.

WARNING

- While checking for space, if there is a risk of collision with pedestrian, animal or object in the direction of vehicle exit, for your safety, Smart Exit function can be turned off.
- Even if check for space is completed, objects in the blind spot area cannot be detected by the sensors. The driver must directly check the blind spot area and continue using the function.

Information

Due to abnormal performance of the ultrasonic sensor or the influence of the surroundings, Parking function may not be able to search for a parking space even if there is a parking space, or may search for a space that is not suitable for parking.

For more information, refer to the "Remote Smart Parking Assist 2 (RSPA 2)" section in this chapter.

3. Select exit direction



With the vehicle stopped by depressing the brake pedal, touch the infotainment system to select the desired exit direction.

WARNING

Before selecting the Exit Direction, the driver should check whether the space for exit is suitable.

If the searched exit space by Remote Smart Parking Assist is narrow or unsuitable (surrounding vehicles are parked vertically, etc.), do not use the Smart Exit function.

4. Smart Exit

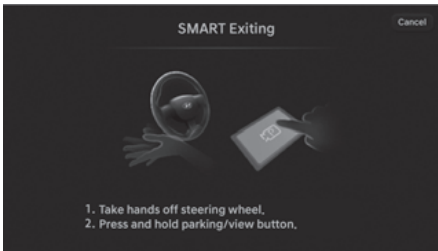

1. Press the Parking/View (P) button when the vehicle is stopped by depressing the brake pedal.
2. When the Parking/View (P) button is pressed, release the brake pedal according to the instructions.
 - Remote Smart Parking Assist will automatically control the steering wheel, vehicle speed and gearshift.
 - While Smart Exit function is operating, if you do not hold down the Parking/View (P) button, the vehicle will stop and function control will pause. The function will start operating again when the Parking/View (P) button is pressed and held again.
3. Press and hold the Parking/View (P) button until exiting is completed.
 - When the vehicle reaches the target exit location, a message will appear on the infotainment system to inform you that exit is completed.

i Information

- Smart Exit function will not operate if the door is open or the seat belt is not fastened.
- Vehicle speed can be adjusted by depressing the brake pedal while Smart Exit function is operating. However, the vehicle does not accelerate even when the accelerator pedal is depressed.
- If exit is completed while depressing the brake pedal, Smart Exit function will complete with the gear in D (Drive).
- If exit is completed while depressing the accelerator pedal, you must take your foot off the accelerator pedal once for the accelerator pedal to operate.
- If there is no vehicle operation such as depressing the brake pedal or accelerator pedal within 4 seconds after exit is complete, the vehicle will automatically shift to P (Park) and engage EPB (Electronic Parking Brake).
- After Exit function is complete, always check the surroundings before driving.

Smart Exit operation status

Operation status	Turn signal
Under control	The turn signal of the exit direction blinks until the exit is complete or Smart Exit is cancelled.

How to turn off Smart function while operating

- Press the Parking/View (P) button in the following stage:
 - Checking space
 - Select exit direction
- Shift the gear to R (Reverse) in the following stage:
 - Checking space
 - Select exit direction
- Press the Parking Safety (P) button or select 'Cancel' on the infotainment system to turn off Exit function.
- While Smart Exit function is operating, if the vehicle is stopped by depressing the brake pedal, and the gear is shifted, Exiting function will turn off. At this time, EPB (Electronic Parking Brake) will not be engaged.

The function will pause in the following conditions when:

- There is a pedestrian, animal or object in the direction the vehicle is moving
- The door or trunk is open
- The driver's seat belt is not fastened
- Parking Collision-Avoidance Assist or Rear-Cross Traffic Collision-Avoidance Assist operates while the vehicle is being controlled in the reverse direction
- The Parking/View (P) button is not continuously pressed
- The vehicle is stopped by depressing the brake pedal

When Exit function is paused, the vehicle will stop. If the condition that made the function to pause disappears, the function may operate again.

The function will cancel in the following conditions when:

- Smart Exit
 - The steering wheel is steered
 - The gear is shifted while the vehicle is moving
 - Operating EPB while the vehicle is moving
 - The hood is open
 - The driver opens the door with the seatbelt unfastened
 - Rapid acceleration occurs
 - Vehicle skid occurs
 - The wheel is stuck by an obstacle and cannot move
 - There are pedestrians, animals or objects at the front and rear of the vehicle at the same time
 - About 3 minutes and 50 seconds have past after Smart Exit function has started to operate
 - The slope of the road exceeds the operational range
 - The function was paused for more than 1 minute
 - The steering wheel, gearshift, braking, and drive controls are not working properly
 - ABS, TCS or ESC system operates due to slippery road conditions
 - The charging door is open

When Smart Exit function is cancelled, the vehicle will automatically stop, shift the gear to P (Park) and engage EPB (Electronic Parking Brake).

Remote Smart Parking Assist malfunction and limitations

Remote Smart Parking Assist malfunction

Remote Smart Parking Assist check

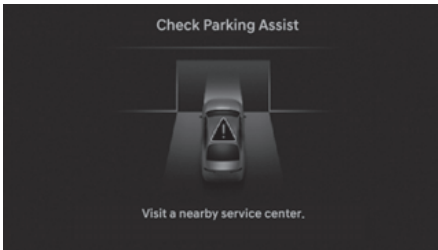

When Remote Smart Parking Assist is not working properly, the '**Check Parking Assist**' warning message will appear on the infotainment system. If the message appears, stop using Remote Smart Parking Assist, and we recommend that you have the vehicle inspected by an authorized HYUNDAI dealer.

Remote Smart Parking Assist canceled



When Remote Parking Assist is operating, the function can be canceled, and the '**Parking Assist Canceled**' warning message may appear regardless of the parking order. Other messages may appear depending on the situations. Follow the instructions provided on the infotainment system while parking your vehicle with Remote Parking Assist. Always look around and pay attention when using Remote Smart Parking Assist.

Remote Smart Parking Assist standby



The '**Parking Assist Conditions Not Met**' message will appear in the following circumstances:

- When '**Parking Assist Conditions Not Met**' message appears when Parking/View (P) button has been pressed and held while Remote Smart Parking Assist is in standby. After a while, press and hold the Parking/View (P) button again to see if Remote Smart Parking Assist works.
- When the smart key's battery is low. Check the smart key battery level.

Limitations of Remote Smart Parking Assist

In the following circumstances, Remote Smart Parking Assist performance to park or exit the vehicle may be limited, there may be a risk of collision, or Remote Smart Parking Assist may turn off. Park or exit the vehicle manually if necessary.

- An object is attached to the steering wheel
- The vehicle is installed with a snow chain, spare tire or different size wheel
- Tire pressure is lower or higher than the standard tire pressure
- Your vehicle is loaded with cargo longer or wider than your vehicle or a trailer is connected to your vehicle
- There is a problem with the wheel alignment
- Your vehicle is leaned severely to one side
- Your vehicle is equipped with a trailer hitch
- The license plate is installed differently from the original location
- There is a person, animal or object above or below the ultrasonic sensor when Remote Smart Parking Assist is activated
- The parking space is curved or diagonal
- There is an obstacle such as a person, animal or object (trash can, bicycle, motorcycle, shopping cart, narrow pillar, etc.) near the parking space
- There is a circular pillar or narrow pillar, or a pillar surrounded by objects such as fire extinguisher, etc., near the parking space

- The road surface is bumpy (curbstone, speed bump, etc.)
- The road is slippery
- The parking space is near a vehicle with higher ground clearance or big, such as a truck, etc.
- The parking space is Inclined
- The road surface of parking space with lines is wet due to snow, puddles, or there is a road marker inside the parking space
- The road surface of the parking space with lines is bumpy due to road cracks
- The parking line is too thin or thick
- The parking line is partially erased or blurred
- The parking line is obscured by people, animals, or objects such as snow, boxes, etc.
- There is heavy wind
- Operating Remote Smart Parking Assist on uneven roads, gravel roads, bushes, etc.
- The performance of the ultrasonic sensor is affected by extremely hot or cold weather
- The ultrasonic sensor is covered with snow or water
- An object that generates ultrasonic waves is nearby
- A wireless device with a transmission function operates near the ultrasonic sensors
- Your vehicle is affected by another vehicle's Parking Distance Warning
- The sensor is mounted or positioned incorrectly by an impact to the bumper
- The cameras is improperly mounted or out of position due to outside rearview mirror damage
- The ultrasonic sensor cannot detect the following objects when:
 - Sharp or slim objects, such as ropes, chains or small poles
 - Objects smaller than 100 cm (40 in.) in length and narrower than 14 cm (6 in.) in diameter
 - Objects which tend to absorb sensor frequency, such as clothes, spongy material or snow
 - A narrow object such as a corner of a square pillar
 - Person, animal or object near the ultrasonic sensor
- The cameras may not properly recognize or may not recognize the parking line and objects when:
 - There are small objects (curb, etc.), sharp objects, or thin objects (rope, etc.) around
 - People, animals or objects are too close or too far from the vehicle
 - Objects are on a higher position, such as pickup trucks
 - The camera is obscured by dirt or moisture
 - The camera is exposed to bright light
 - The surrounding is too dark
 - The light is reflected from the surface

Remote Smart Parking Assist may not operate properly under the following circumstances:

- Parking on inclines



Park or exit manually when the vehicle is on inclines.

- Parking on uneven road



Remote Smart Parking Assist may cancel when the vehicle slips, or the vehicle cannot move due to road conditions such as pebbles or fragmented stones.

- Parking behind a truck



Do not use Remote Smart Parking Assist around vehicles with higher ground clearance, such as a bus, truck, etc. It may lead to an accident.

- Parking near a pillar

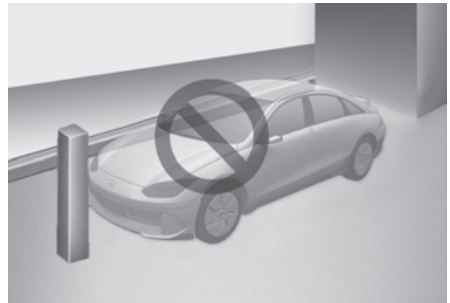

Remote Smart Parking Assist performance may reduce or collision with an obstacle may occur when there is a narrow object, circular pillar, square pillar, or a pillar surrounded by objects such as a fire extinguisher, etc., near the parking space. The driver should park the vehicle manually.

- Parking next to a misaligned vehicle



If Remote Smart Parking Assist is used when parking in a space next to misaligned vehicles, your vehicle may not be parked side by side.

However, if there is a parking line and it is detected properly, your vehicle will park side by side with the parking line.

- Leaving a parking space near a wall or parking in a narrow space

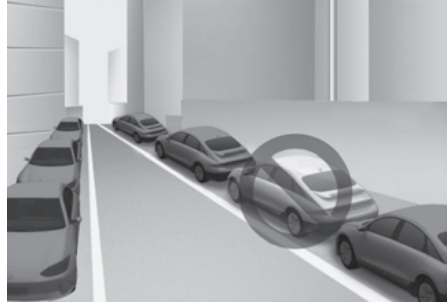

- Remote Smart Parking Assist may not operate properly when leaving a parking space that is narrow and near a wall. Always check for pedestrians, animals, objects while leaving.
- For your safety, Remote Smart Parking Assist does not search for parking spaces at areas with narrow parking spaces that are narrower than the minimum space required for parking.

Remote Smart Parking Assist may not operate properly when parking in a narrow space. Always check for pedestrians, animals, objects while parking.

- Parking in snow



Snow may interfere with the operation of the ultrasonic sensor and wide view camera, or Remote Smart Parking Assist may cancel if the road is slippery while parking.

- Abnormal parking space

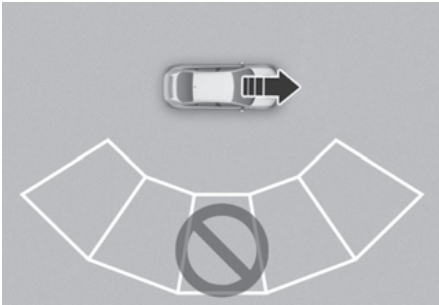

Remote Smart Parking Assist does not work properly when the parking lines are not parallel. Do not park although the parking space is recognized by the sensor.

- Inclined parking space

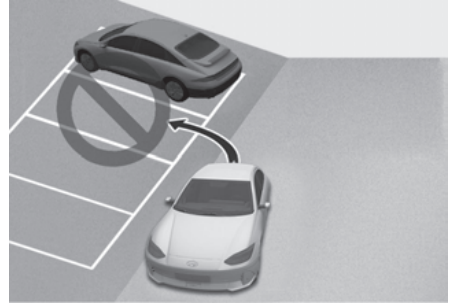

Remote Smart Parking Assist does not work properly on a inclined or curved road surface. Do not park although the parking space is recognized by the sensor.

- Parking diagonal



Remote Operation function may not operate properly in a diagonal parking space.

 **WARNING**

Take the following precautions when using Remote Smart Parking Assist:

- The driver is responsible for safe parking and exit when using Remote Smart Parking Assist.
 - When using Remote Smart Parking Assist, stay out of the way in the direction the vehicle moves for your safety.
 - Always check surroundings when using Remote Smart Parking Assist. You may collide with pedestrians, animals, or objects if they are near the sensor or are in the sensor's blind spot area.
 - A collision may occur if a pedestrian, animal, or object suddenly appears while Remote Smart Parking Assist is operating.
 - Do not use Remote Smart Parking Assist when under the influence of alcohol.
 - Do not let children or other people to use the smart key.
 - If Remote Smart Parking Assist is used continuously for a long period, it may adversely affect Remote Smart Parking Assist performance.
 - Remote Smart Parking Assist may not operate properly if the vehicle needs wheel alignment adjustment such as when the vehicle tilts to one side. We recommend that you have the vehicle inspected by an authorized HYUNDAI dealer.
- Noise may be heard when braking occurs by Remote Smart Parking Assist or when the brake pedal is depressed by the driver.
 - Remote Smart Parking Assist may suddenly apply the brake to avoid collision with pedestrian, animal, or object.
 - Use Remote Smart Parking Assist only in a parking space that is large enough for the vehicle to move safely.
 - If Remote Smart Parking Assist does not operate properly, we recommend that you have the vehicle inspected by an authorized HYUNDAI dealer.
-

NOTICE

- If the 3rd stage warning (continuous beep) of the Forward/Reverse Parking Distance Warning sounds while Remote Smart Parking Assist is operating, it means the obstacle detected is close to your vehicle. At this time, Remote Smart Parking Assist will temporarily stop operating. Make sure there are no pedestrians, animals, or objects around your vehicle.
 - Depending on brake operation, the stop lights may come on while the vehicle is moving.
 - If the vehicle is remotely started that has been parked in cold weather for a long time, the operation of Remote Parking function may be delayed or canceled depending on vehicle condition.
-

Declaration of conformity

Front radar

+ if equipped

The radio frequency components complies:

- For Europe and other Europe territories

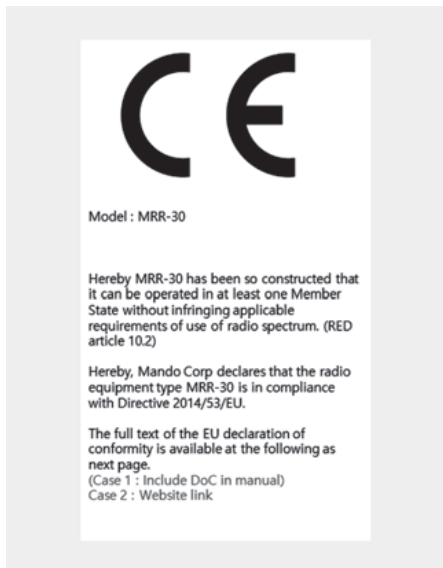

- For Korea



- For United Kingdom



- For Japan



- For Oman

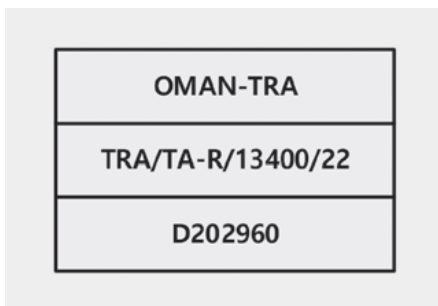

- For United Arab Emirates



- For Jordan

TRC/31/9731/2022

- For Uzbekistan



- For Israel

תרוסקתה דרשמ טעמ המאתה רושיא רוסמ : 55-11766
 לש תיטוחלאה ויתונכת תא תונשל ידכ נהב שיש רישנמב תולועפ עעבל רוסיא לח
 הז ללבו, רישמה
 אלב, תינוצח הנטאל רוביחל תורשאפ תפסוה או תירוקמ הנטא תפלחה, רגנסת ייניש
 רושיא תלבק
 תיטוחלא תוערפהל ששאה לשב, תרוסקתה דרשמ.

- For Thailand



- For Taiwan



電信法第 48 條, 低功率電波輻射性電機管理辦法
 第十二條
 經型式認證合格之低功率射頻電機, 非經許可, 公司、商號或使用者均不得擅自變更頻率、加大功率或變更原設計之特性及功能。
 第十四條
 低功率射頻電機之使用不得影響飛航安全及干擾合法通信; 經發現有干擾現象時, 應立即停用, 並改善至無干擾時方得繼續使用。前項合法通信, 指依電信法規定作業之無線電通信。低功率射頻電機須忍受合法通信或工業、科學及醫療用電波輻射性電機設備之干擾。

Article 12
 Without permission, any company, firm or user shall not alter the frequency, increase the power, or change the characteristics and functions of the original design of the certified lower power frequency electric machinery.

Article 14
 The application of low power frequency electric machineries shall not affect the navigation safety nor interfere a legal communication, if an interference is found, the service will be suspended until improvement is made and the interference no longer exist.

- For Paraguay



NR : 2021-03-I-0138

- For Singapore

Complies with
 IMDA Standards
 N1589-22

- For Philippines



- For China

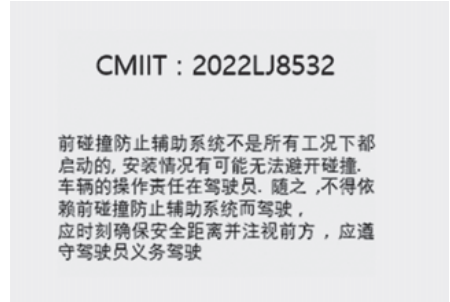

- For Mexico



- Republic of South Africa



- For Brazil



- For Indonesia



Front corner radar/Rear corner radar

 if equipped

The radio frequency components (Rear corner radar) complies:

- For Singapore (GEN1/GEN2)



- For Malaysia (GEN1/GEN2)



- For Korea (SRR5 GEN2)



- For Japan (SRR5 GEN2)



- For Europe and CE certified countries (SRR5 GEN2)

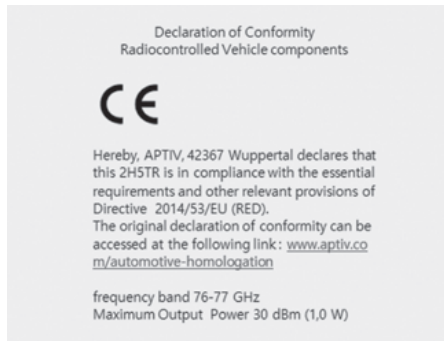

- For United Kingdom (SRR5 GEN2)



- For Australia (GEN1/GEN2)



- For Nigeria (GEN1/GEN2)

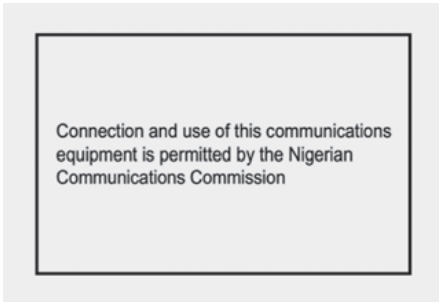

- For Mexico (SRR5 GEN2)

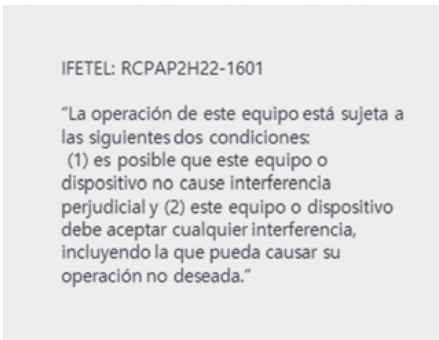

- For Brazil (SRR5 GEN2)



- For Serbia (SRR5 GEN2)



- For Morocco (SRR5 GEN2)



- For Republic of South Africa (SRR5 GEN2)



- For Paraguay (SRR5 GEN2)



- For Zambia (SRR5 GEN2)



- For Oman (SRR5 GEN2)

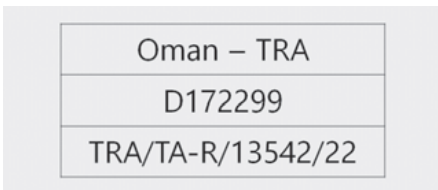

- For Ghana (SRR5 GEN2)

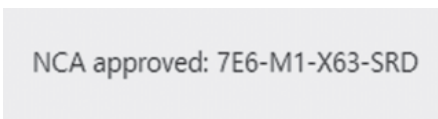

- For Pakistan (SRR5 GEN2)



- For Senegal (SRR5 GEN2)



- For Indonesia (SRR5 GEN2)



- For Jordan (SRR5 GEN2)

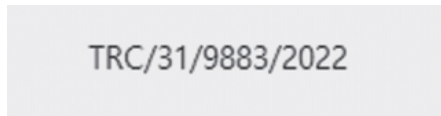

• For Taiwan (SRR5 GEN2)



電信法第 48 條, 低功率電波輻射性電機管理辦法
第十二條
經型式認證合格之低功率射頻電機, 非經許可, 公司、商號或使用者均不得擅自變更頻率、加大功率或變更原設計之特性及功能。
第十四條
低功率射頻電機之使用不得影響飛航安全及干擾合法通信; 經發現有干擾現象時, 應立即停用, 並改善至無干擾時方得繼續使用。前項合法通信, 指依電信法規定作業之無線電通信。低功率射頻電機須忍受合法通信或工業、科學及醫療用電波輻射性電機設備之干擾。

Article 12
Without permission, any company, firm or user shall not alter the frequency, increase the power, or change the characteristics and functions of the original design of the certified lower power frequency electric machinery.

Article 14
The application of low power frequency electric machineries shall not affect the navigation safety nor interface a legal communication, if an interference is found, the service will be suspended until improvement is made and the interference no longer exist.

• For Thailand (SRR5 GEN2)



1) เครื่องใช้รบกวนความถี่วิทยุประเภทนี้ มีความสอดคล้องตามมาตรฐานเพื่อข้อกำหนดของ กสทศ.
2) เครื่องใช้รบกวนความถี่วิทยุระดับการแผ่คลื่นแม่เหล็กไฟฟ้าสอดคล้องตามมาตรฐานความปลอดภัยต่อสุขภาพของมนุษย์จากการใช้เครื่องใช้รบกวนความถี่วิทยุตามคณะกรรมการกิจการโทรคมนาคมแห่งชาติประกาศกำหนด

• For Ukraine (SRR5 GEN2)



UA RF: 1APTV 2HTR

справжнім (найменування виробника) заявляє, що тип радіобладнання (позначення типу радіобладнання) відповідає Технічному регламенту радіобладнання;

повний текст декларації про відповідність доступний на веб-сайті за такою адресою:
www.aptiv.com/automotive-homologation

• For Israel (SRR5 GEN2)

מסמך מס' 63-66570 : תקן מספר

א. השימוש במכשיר הינו על סיסם "משטר" אסור מרשון הפעלה אלוס. כלומר - לא מוגן מהפרעות ולא הפרעה למערכות אחרות הפועלות כדוגמא ב. רק "בכפפות בוקן" לשימוש עצמי של הלקוח בכבוד, היחיד סבור משרדן הפעלה אלוסטי. ג. אסור להחליף את האנטנה המקורית של המכשיר, ולא לעשות בו כל שינוי טכני אחר. הספק הסידור של א.מ.ע.לה על "output power of the device"

- For Philippine (SRR5 GEN2)



- For United Arab Emirates (SRR5 GEN2)



- For China (SRR5 GEN2)

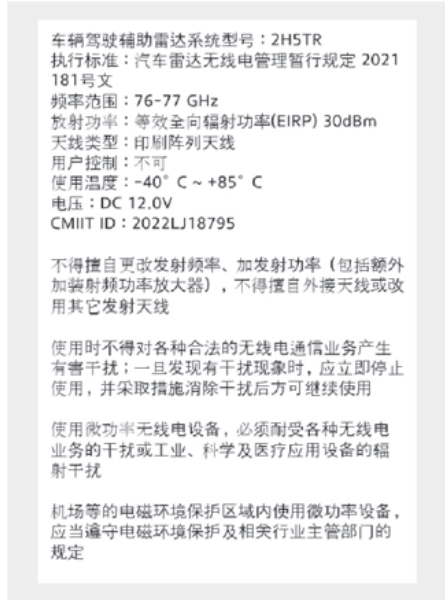

8. Emergency situations

Hazard warning flasher	8-3
In case of an emergency while driving	8-3
If the vehicle stalls while driving.....	8-3
If the vehicle stalls at a crossroad or crossing	8-3
If you have a flat tire while driving.....	8-4
If the vehicle will not start.....	8-4
Confirm the EV battery is not low on the charge gauge.....	8-4
Jump starting (12 V battery).....	8-5
Tire Pressure Monitoring System (TPMS)	8-9
Check tire pressure	8-9
Tire pressure monitoring system	8-10
Low tire pressure warning light	8-11
Low tire pressure position and tire pressure telltale	8-11
TPMS (Tire Pressure Monitoring System) malfunction indicator	8-12
Changing a tire with TPMS	8-13
If you have a flat tire (with Tire Mobility Kit).....	8-15
Introduction.....	8-15
Notes on the safe use of the Tire Mobility Kit.....	8-16
Components of the Tire Mobility Kit	8-17
Using the Tire Mobility Kit When a tire is flat.....	8-18
How to adjust tire pressure	8-21
Towing.....	8-22
Towing service	8-22
Removable towing hook.....	8-23
Emergency commodity.....	8-24
Fire extinguisher	8-24
First aid kit.....	8-25
Triangle reflector.....	8-25
Tire pressure gauge	8-25
Pan-European eCall System (For EUROPE)	8-26
Information on data processing (For Europe).....	8-29
Pan-European eCall System (For Europe).....	8-31
UAE eCall System (For UAE)	8-35
Information on data processing (For UAE).....	8-38
UAE eCall System (For UAE).....	8-40

eCall certification label 8-43

Hazard warning flasher

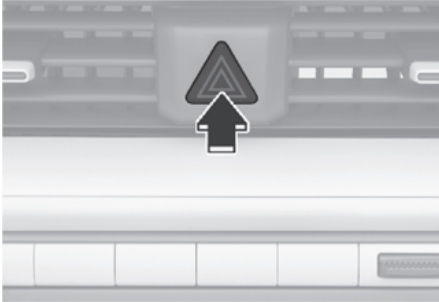

The hazard warning flasher serves as a warning to other drivers to exercise extreme caution when approaching, overtaking, or passing your vehicle.

It should be used whenever emergency repairs are being made or when the vehicle is stopped near the edge of a roadway.

To turn the hazard warning flasher on or off, press the hazard warning flasher button with the Start/Stop button in any position. The hazard warning flasher button is located in the center fascia panel. All turn signal lights will flash simultaneously.

- The hazard warning flasher operates regardless of whether your vehicle is running or not.
- The turn signals do not work when the hazard flasher is on.

In case of an emergency while driving

If the vehicle stalls while driving

- Reduce your speed gradually, keeping a straight line. Move cautiously off the road to a safe place.
- Turn on your hazard warning flasher.
- Try to start the vehicle again. If your vehicle will not start, we recommend that you contact an authorized HYUNDAI dealer or seek other qualified assistance.

If the vehicle stalls at a crossroad or crossing

If the vehicle stalls at a crossroads or crossing, if safe to do so, shift the gear to N (Neutral) and then push the vehicle to a safe location.

To stay N (Neutral) while the vehicle is off, refer to the "To stay in N (Neutral) when vehicle is OFF" section in chapter 6.

If you have a flat tire while driving

If a tire goes flat while you are driving:

- Take your foot off the accelerator pedal and let the vehicle slow down while driving straight ahead. Do not apply the brakes immediately or attempt to pull off the road as this may cause loss of vehicle control resulting in an accident. When the vehicle has slowed to such a speed that it is safe to do so, brake carefully and pull off the road. Drive off the road as far as possible and park on firm, level ground. If you are on a divided highway, do not park in the median area between the two traffic lanes.
- When the vehicle is stopped, press the hazard warning flasher button, shift the gear to P (Park), apply the parking brake, and press the Start/Stop button to the OFF position.
- Have all passengers get out of the vehicle. Be sure they all get out on the side of the vehicle that is away from traffic.
- When changing a flat tire, follow the instructions provided later in this chapter.

If the vehicle will not start

Confirm the EV battery is not low on the charge gauge

- Be sure the gear is in P (Park). The vehicle starts only when the gear is in P (Park).
- Check the 12 V battery connections to be sure they are clean and tight.
- Turn on the interior light. If the light dims or goes out when you operate the starter, the 12 V battery is drained.

Do not push or pull the vehicle to start it. This could cause damage to your vehicle.

Jump starting (12 V battery)

Jump starting can be dangerous if done incorrectly. Follow the jump starting procedure in this section to avoid serious injury or damage to your vehicle. If in doubt about how to properly jump start your vehicle, we strongly recommend that you have a service technician or towing service do it for you.

WARNING

To prevent SERIOUS INJURY or DEATH to you or bystanders, always follow these precautions when working near or handling the battery:



Always read and follow instructions carefully when handling a battery.



Wear eye protection designed to protect the eyes from acid splashes.



Keep all flames, sparks, or smoking materials away from the battery.



Hydrogen is always present in battery cells, is highly combustible, and may explode if ignited.



Keep batteries out of reach of children.



Batteries contain sulfuric acid which is highly corrosive. Do not allow acid to contact your eyes, skin or clothing.

If acid gets into your eyes, flush your eyes with clean water for at least 15 minutes and get immediate medical attention. If acid gets on your skin, thoroughly wash the area. If you feel pain or a burning sensation, get medical attention immediately.

- When lifting a plastic-cased battery, excessive pressure on the case may cause battery acid to leak. Lift with a battery carrier or with your hands on opposite corners.
- Do not attempt to jump start your vehicle if your battery is frozen.
- NEVER attempt to recharge the battery when the vehicle's battery cables are connected to the battery.
- The electrical ignition system works with high voltage.
NEVER touch these components with the vehicle running or when the Start/Stop button is in the ON position.
- The electrical ignition system works with high voltage. NEVER touch these components with the (READY) indicator ON or when the Start/Stop button is in the ON position.

- Do not allow the (+) and (-) jumper cables to touch. It may cause sparks.
- The battery may rupture or explode when you jump start with a low or frozen battery.
- Do not directly connect the (-) to the jump cable. Connect the (-) to the one of the metallic parts located far from the jump cable in the vehicle. The direct (-) connection to the jump cable may cause an explosion.
- Be sure to use only 12 V battery to jump start. Using batteries with other voltages to jump start can damage the battery or even provoke an explosion.

Jump starting procedure

***i* Information**

When you jump start your vehicle, use the jumper terminal in the motor compartment.

1. Position the vehicles close enough that the jumper cables will reach, but do not allow the vehicle body parts to contact.
2. Avoid fans or any moving parts in the motor compartment at all times, even when the vehicles are turned off.
3. Turn off all electrical devices such as radios, lights, air conditioning, etc. Put the vehicles in P (Park) and set the parking brake. Turn both vehicles OFF.

4. Open the hood.
5. Remove the battery cover located inside of the front trunk.
6. Remove the motor compartment fuse box cover.

CAUTION

Before jump starting, make sure to correctly identify the positive (+) and negative (-) terminals to avoid reverse polarity connections.

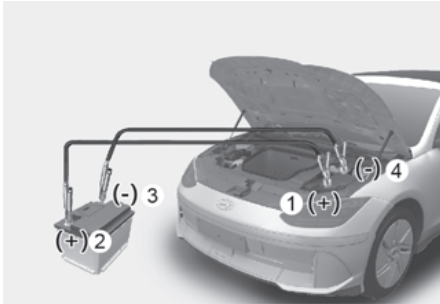

7. Connect the jumper cables in the exact sequence shown in the illustration. First connect one jumper cable to the red, positive (+) jumper terminal of your vehicle (1).
8. Connect the other end of the jumper cable to the red, positive (+) battery/jumper terminal of the assisting vehicle (2).
9. Connect the second jumper cable to the black, negative (-) battery/jumper terminal of the assisting vehicle (3).

10. Connect the other end of the second jumper cable to the black, negative (-) chassis ground of your vehicle (4).

Do not allow the jumper cables to contact anything except the correct battery or jumper terminals or the correct ground. Do not lean over the battery when making connections.

WARNING

Do not connect the jumper cable to the negative (-) jumper terminal of the discharged battery. A spark could cause the battery to explode and lead to a personal injury or vehicle damage.

11. Start the assisting vehicle and let it run at about for a few minutes. Then start your vehicle.
12. Keep your vehicle operating for at least 30 minutes at idle or driving to assure your battery receives enough charge to be able to start on its own after the vehicle is shut off. A complete dead battery may require as long as 60 minutes runtime to fully recharge it. If vehicle is run for less, the battery may not restart.

If your vehicle will not start after a few attempts, it probably requires servicing. In this event please seek qualified assistance. If the cause of your battery discharging is not apparent, we recommend that you have your vehicle inspected by an authorized HYUNDAI dealer.

Disconnect the jumper cables in the exact reverse order you connected them:

1. Disconnect the jumper cable from the black, negative (-) chassis ground of your vehicle (4).
2. Disconnect the other end of the jumper cable from the black, negative (-) battery/chassis ground of the assisting vehicle (3).
3. Disconnect the second jumper cable from the red, positive (+) battery/jumper terminal of the assisting vehicle (2).
4. Disconnect the other end of the jumper cable from the red, positive (+) jumper terminal of your vehicle (1).

i Information



An inappropriately disposed battery can be harmful to the environment and human health. Dispose of the battery according to your local law(s) or regulations.

NOTICE

To prevent damage to your vehicle:

- Only use a 12 V power supply (battery or jumper system) to jump start your vehicle.
 - Do not attempt to jump start your vehicle by push-starting.
 - Always be sure that the battery cover and cable are tightened after finishing jump start your vehicle. Otherwise is may cause damage to the relevant parts, noise trouble, or entrance of foreign substances.
-

! WARNING

While jump starting your vehicle, avoid the positive (+) and negative (-) cables to come in contact. A spark could cause personal injury.

Tire Pressure Monitoring System (TPMS)

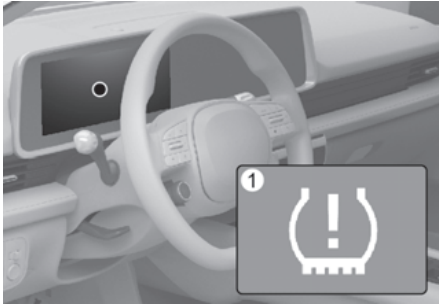

- (1) Low Tire Pressure Telltale/TPMS Malfunction Indicator
- (2) Low Tire Pressure Position Telltale and Tire Pressure Telltale (Shown on the cluster display)

Check tire pressure



- You can check the tire pressure in the Utility view on the cluster display. Refer to the "View modes" section in chapter 4.
- Tire pressure is displayed after a few minutes of driving after initial vehicle start up.
- If tire pressure is not displayed when the vehicle is stopped, '**Drive to display**' message will appear. After driving, check the tire pressure.
- The displayed tire pressure values may differ from those measured with a tire pressure gauge.
- You can change the tire pressure unit from the Settings menu in the infotainment system. Select:
 - **Setup > General Settings > Unit > Tire Air Pressure Unit > psi/kPa/bar**

i Information

The infotainment system may change after software updates. For more information, refer to the manual provided in the infotainment system and the quick reference guide.

Tire pressure monitoring system

WARNING

Over-inflation or under-inflation can reduce tire life, adversely affect vehicle handling, and lead to sudden tire failure that may cause loss of vehicle control resulting in an accident.

Each tire, including the spare (if provided), should be checked monthly when cold and inflated to the inflation pressure recommended by the vehicle manufacturer on the vehicle placard or tire inflation pressure label. (If your vehicle has tires of a different size than the size indicated on the vehicle placard or tire inflation pressure label, you should determine the proper tire inflation pressure for those tires.)

As an added safety feature, your vehicle has been equipped with a tire pressure monitoring system (TPMS) that illuminates a low tire pressure telltale when one or more of your tires is significantly under-inflated. Accordingly, when the low tire pressure telltale illuminates, you should stop and check your tires as soon as possible, and inflate them to the proper pressure. Driving on a significantly under-inflated tire causes the tire to overheat and can lead to tire failure.

Under-inflation also reduces energy economy and tire tread life, and may affect the vehicle's handling and stopping ability.

Please note that the TPMS is not a substitute for proper tire maintenance, and it is the driver's responsibility to maintain correct tire pressure, even if under-inflation has not reached the level to trigger illumination of the TPMS low tire pressure telltale.

Your vehicle has also been equipped with a TPMS malfunction indicator to indicate when the system is not operating properly. The TPMS malfunction indicator is combined with the low tire pressure telltale. When the system detects a malfunction, the telltale will flash for about one minute and then remain continuously illuminated. This sequence will continue upon subsequent vehicle start-ups as long as the malfunction exists.

When the malfunction indicator is illuminated, the system may not be able to detect or signal low tire pressure as intended. TPMS malfunctions may occur for a variety of reasons, including the installation of replacement or alternate tires or wheels on the vehicle that prevent the TPMS from functioning properly.

Always check the TPMS malfunction telltale after replacing one or more tires or wheels on your vehicle to ensure that the replacement or alternate tires and wheels allow the TPMS to continue to function properly.

NOTICE

If any of the below happens, we recommend that you have the system checked by an authorized HYUNDAI dealer.

1. The Low Tire Pressure Telltale/TPMS Malfunction Indicator does not illuminate for 3 seconds when the Start/Stop button is pressed to the ON position or when the vehicle is running.
2. The TPMS Malfunction Indicator remains illuminated after blinking for about 1 minute.
3. The Low Tire Pressure Position Telltale remains illuminated.

Low tire pressure warning light



Low tire pressure position and tire pressure telltale



When the tire pressure monitoring system warning indicators are illuminated and a warning message displayed on the cluster display, one or more of your tires is significantly under-inflated. The Low Tire Pressure Position Telltale will indicate which tire is significantly underinflated by illuminating the corresponding position light.

If either telltale illuminates, immediately reduce your speed, avoid hard cornering and anticipate increased stopping distances. You should stop and check your tires as soon as possible. Inflate the tires to the proper pressure as indicated on the vehicle's placard or tire inflation pressure label located on the driver's side center pillar outer panel.

If you cannot reach a service station or if the tire cannot hold the newly added air, replace the low pressure tire with the spare tire.

The Low Tire Pressure Telltale will remain on and the TPMS Malfunction Indicator may blink for one minute and then remain illuminated (when the vehicle is driven about 10 minutes at speed above 25 km/h (15.5 mph)) until you have the low pressure tire repaired and replaced on the vehicle.

CAUTION

In winter or cold weather, the Low Tire Pressure Telltale may be illuminated if the tire pressure was adjusted to the recommended tire inflation pressure in warm weather. It does not mean your TPMS is malfunctioning because the decreased temperature leads to a proportional lowering of tire pressure.

When you drive your vehicle from a warm area to a cold area or from a cold area to a warm area, or the outside temperature is greatly higher or lower, you should check the tire inflation pressure and adjust the tires to the recommended tire inflation pressure.

WARNING

Low pressure damage

Significantly low tire pressure makes the vehicle unstable and can contribute to loss of vehicle control and increased braking distances.

Continued driving on low pressure tires can cause the tires to overheat and fail.

TPMS (Tire Pressure Monitoring System) malfunction indicator

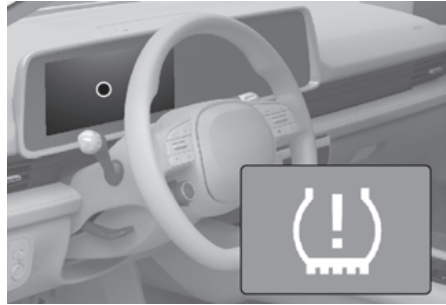

The TPMS Malfunction Indicator will illuminate after it blinks for about one minute when there is a problem with the Tire Pressure Monitoring System.

We recommend that the system be checked by an authorized HYUNDAI dealer as soon as possible.

NOTICE

If there is a malfunction with the TPMS, the Low Tire Pressure Position Telltale will not be displayed even though the vehicle has an under-inflated tire.

NOTICE

The TPMS Malfunction Indicator may illuminate after blinking for one minute if the vehicle is near electric power supply cables or radio transmitters such as police stations, government and public offices, broadcasting stations, military installations, airports, transmitting towers, etc.

Additionally, the TPMS Malfunction Indicator may illuminate if snow chains are used or electronic devices such as computers, chargers, remote starters, navigation, etc. This may interfere with normal operation of the TPMS.

Changing a tire with TPMS

If you have a flat tire, the Low Tire Pressure and Position telltales will come on. We recommend that the flat tire be repaired by an authorized HYUNDAI dealer as soon as possible or replace the flat tire with the spare tire.

NOTICE

It is recommended that you do not use a puncture-repairing agent not approved by an authorized HYUNDAI dealer or the equivalent specified for your vehicle to repair and/or inflate a low pressure tire. Tire sealant not approved by an authorized HYUNDAI dealer or the equivalent specified for your vehicle may damage the tire pressure sensor.

The spare tire (if equipped) does not come with a tire pressure monitoring sensor. When the low pressure tire or the flat tire is replaced with the spare tire, the Low Tire Pressure Telltale will remain on. Also, the TPMS Malfunction Indicator will illuminate after blinking for one minute if the vehicle is driven at speed above 25 km/h (15.5 mph) for about 10 minutes.

Once the original wheel equipped with a tire pressure monitoring sensor is reinflated to the recommended pressure and reinstalled on the vehicle, the Low Tire Pressure Telltale and TPMS Malfunction Indicator will go off within a few minutes of driving.

If the indicators do not extinguish after a few minutes we recommend to consult an authorized HYUNDAI dealer.

Each wheel is equipped with a tire pressure sensor mounted inside the tire behind the valve stem (except for the spare tire). You must use TPMS specific wheels. It is recommended that you always have your tires serviced by an authorized HYUNDAI dealer.

You may not be able to identify a tire with low pressure by simply looking at it. Always use a good quality tire pressure gauge to measure. Please note that a tire that is hot (from being driven) will have a higher pressure measurement than a tire that is cold.

A cold tire means the vehicle has been sitting for 3 hours and driven for less than 1.6 km (1 mi.) in that 3 hour period.

Allow the tire to cool before measuring the inflation pressure. Always be sure the tire is cold before inflating to the recommended pressure.

WARNING

- The TPMS cannot alert you to severe and sudden tire damage caused by external factors such as nails or road debris.
 - If you feel any vehicle instability, immediately take your foot off the accelerator, apply the brakes gradually with light force, and slowly move to a safe position off the road.
-

WARNING

Tampering with, modifying, or disabling the Tire Pressure Monitoring System (TPMS) components may interfere with the system's ability to warn the driver of low tire pressure conditions and/or TPMS malfunctions. Tampering with, modifying, or disabling the Tire Pressure Monitoring System (TPMS) components may void the warranty for that portion of the vehicle.

WARNING

For Europe

- Do not modify the vehicle; it may interfere with the TPMS function.
- The wheels on the market do not have a TPMS sensor.

For your safety, we recommend that you use parts for replacement from an authorized HYUNDAI dealer.

- If you use the wheels on the market, use a TPMS sensor approved by an authorized HYUNDAI dealer or the equivalent approved for your vehicle. If your vehicle is not equipped with a TPMS sensor or TPMS does not work properly, you may fail the periodic vehicle inspection conducted in your country.
-

If you have a flat tire (with Tire Mobility Kit)

 if equipped



For safe operation, carefully read and follow the instructions in this manual before use.

- (1) Compressor
- (2) Sealant bottle

The tire mobility kit is a temporary fix to the tire we recommend the tire be inspected by an authorized HYUNDAI dealer or the equivalent approved for your vehicle as soon as possible.

CAUTION

When two or more tires are flat, do not use the tire mobility kit because the supported one sealant of Tire Mobility Kit is only used for one flat tire.

WARNING

Do not use the Tire Mobility Kit to repair punctures in the tire walls. This can result in an accident due to tire failure.

WARNING

Have your tire repaired as soon as possible. The tire may lose air pressure at any time after inflating with the Tire Mobility Kit.

Introduction

With the Tire Mobility Kit you stay mobile even after experiencing a tire puncture.

The compressor and sealing compound system effectively and comfortably seals most punctures in a passenger car tire caused by nails or similar objects and reinflates the tire.

After you ensure that the tire is properly sealed you can drive cautiously on the tire (distance up to 200 km (120 mi.)) at a max. speed of 80 km/h (50 mph) in order to reach a service station or tire dealer for the tire replacement.

It is possible that some tires, especially with larger punctures or damage to the sidewall, cannot be sealed completely.

Air pressure loss in the tire may adversely affect tire performance.

For this reason, you should avoid abrupt steering or other driving maneuvers, especially if the vehicle is heavily loaded or if a trailer is in use.

The Tire Mobility Kit is not designed or intended as a permanent tire repair method and is to be used for one tire only.

This instruction shows you step by step how to temporarily seal the puncture simply and reliably.

Read the section Notes on the safe use of the Tire Mobility Kit.



WARNING

Do not use the TMK if a tire is severely damaged by driving run flat or with insufficient air pressure.

Only punctured areas located within the tread region of the tire can be sealed using the TMK.

Notes on the safe use of the Tire Mobility Kit

- Park your car at the side of the road so that you can work with the Tire Mobility Kit away from moving traffic.
- To be sure your vehicle will not move, even when you're on fairly level ground, always set your parking brake.
- Only use the Tire Mobility Kit for sealing/inflation passenger car tires. Only punctured areas located within the tread region of the tire can be sealed using the tire mobility kit.
- Do not use on motorcycles, bicycles or any other type of tires.
- When the tire and wheel are damaged, do not use Tire Mobility Kit for your safety.
- Use of the Tire Mobility Kit may not be effective for tire damage larger than about 4 mm (0.16 in.).
- If the tire cannot be made roadworthy with the Tire Mobility Kit, we recommend that you contact an authorized HYUNDAI dealer.
- Do not use the Tire Mobility Kit if a tire is severely damaged by driving run flat or with insufficient air pressure.
- Do not remove any foreign objects such as nails or screws that have penetrated the tire.
- Provided the car is outdoors, leave the Vehicle is ON (READY indicator ON). Otherwise operating the compressor may eventually drain the car battery.
- Never leave the Tire Mobility Kit unattended while it is being used.
- Do not leave the compressor running for more than 10 minutes at a time or it may overheat.
- Do not use the Tire Mobility Kit if the ambient temperature is below -30 °C (-22 °F).
- In case of skin contact with the sealant, wash the area thoroughly with plenty of water. If the irritation persists, seek medical attention.
- In case of eye contact with the sealant, flush your eyes for at least 15 minutes. If the irritation persists, seek medical attention.
- In case of swallowing the sealant, rinse the mouth and drink plenty of water. However, never give anything to an unconscious person and seek medical attention immediately.
- Long time exposure to the sealant may cause damage to bodily tissue such as kidney, etc.

Components of the Tire Mobility Kit

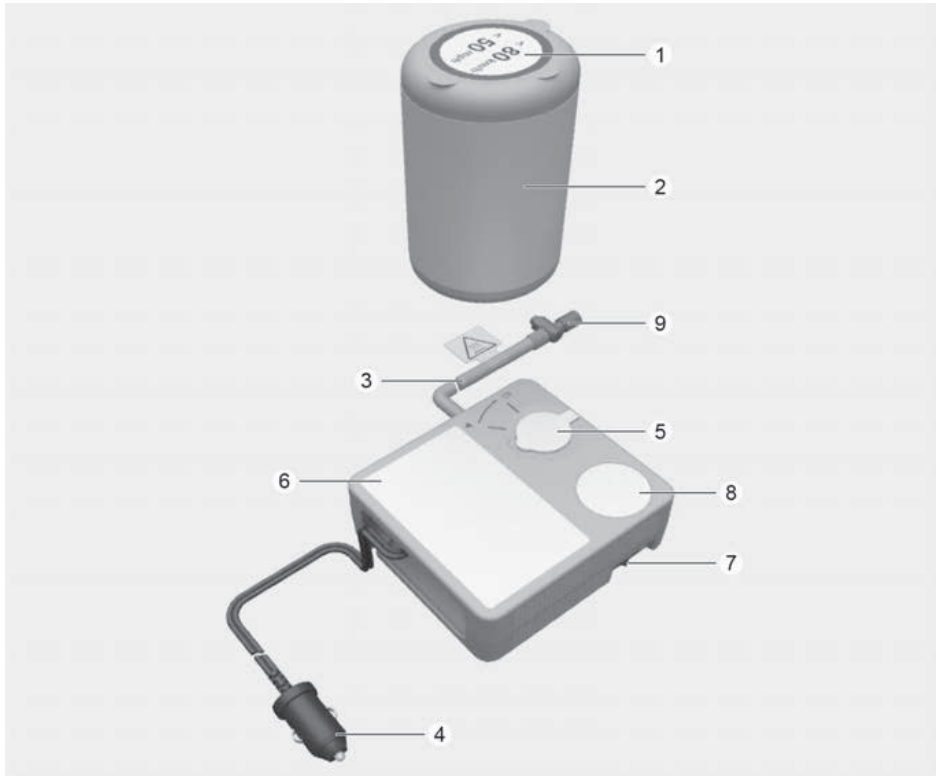

- (1) Speed-restriction label
- (2) Sealant bottle and label with speed restriction
- (3) Filling hose
- (4) Connectors and cable for the power outlet direct connection
- (5) Holder for the sealant bottle
- (6) Compressor
- (7) ON/OFF switch
- (8) Pressure gauge for displaying the tire inflation pressure
- (9) Button for reducing the tire inflation pressure

Connectors, cable and connection hose are stored in the compressor housing.

Strictly follow the specified sequence, otherwise the sealant may escape under high pressure.

WARNING

Expired sealant

Do not use the Tire sealant after the sealant has expired (for example, pasted the expiration date on the sealant container). This can increase the risk of tire failure.

WARNING

Sealant

- Keep out of reach of children.
- Avoid contact with eyes.
- Do not swallow.

Using the Tire Mobility Kit When a tire is flat

CAUTION



Detach the speed restriction label (1) from the sealant bottle (2), and place it in a highly visible place inside the vehicle such as on the steering wheel to remind the driver not to drive too fast.

CAUTION

If only the tire pressure needs to be adjusted, refer to the "How to adjust tire pressure" section in this chapter.

Before using the Tire Mobility Kit, be fully aware of the explanation on the sealant.



1. Shake the sealant bottle (2).



2. Remove the sealant bottle (2) cap and sealant bottle holder (5) cap and screw the bottle onto the sealant bottle holder.
3. Make sure the compressor valve on the filling hose is locked.

4. Unscrew the valve cap and screw the filling hose (3) onto the tire valve.

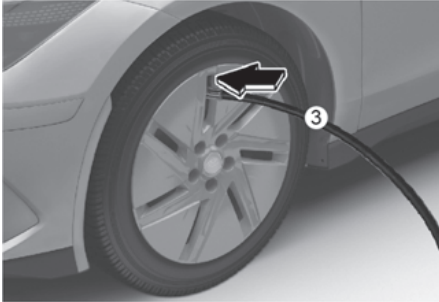

⚠ CAUTION

Securely install the sealant filling hose to the valve. If not, sealant may flow backward, possibly clogging the filling hose.



5. Make sure the compressor is turned off and plug the compressor power cord (4) into the vehicle power outlet.

6. With the vehicle ON (**READY** indicator ON), switch on the compressor and let it run for about 5-7 minutes to fill the sealant up to proper pressure. (refer to the "Tires and wheels" section in chapter 2). The inflation pressure of the tire after filling is unimportant and will be checked/corrected later.

Be careful not to overinflate the tire and stay away from the tire when filling it.

⚠ CAUTION

Tire pressure

Do not attempt to drive your vehicle if the tire pressure is below 200 kPa (29 psi). This could result in an accident due to sudden tire failure.

7. Switch off the compressor.
8. Detach the hoses from the sealant bottle connector and from the tire valve.

Return the Tire Mobility Kit to its storage location in the vehicle.

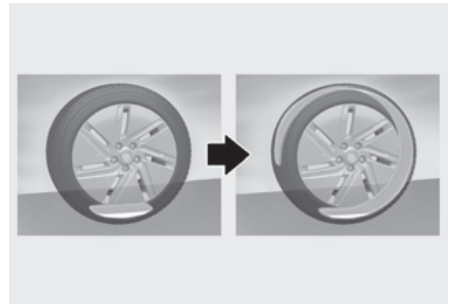

9. Immediately drive about 7-10 km (4-6 mi. or, about 10 minutes) to evenly distribute the sealant in the tire.

Do not exceed a speed of 80 km/h (50 mph). If possible, do not fall below a speed of 20 km/h (12 mph).

While driving, if you experience any unusual vibration, ride disturbance or noise, reduce your speed and drive with caution until you can safely pull off of the side of the road.

Call for road side service or towing.

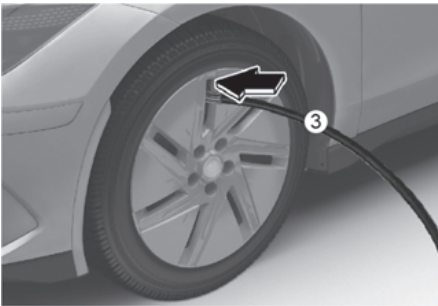

10. After driving about 7-10 km (4-6 mi. or about 10 minutes), stop at a safety location.

11. Connect the filling hose (3) of the compressor directly to the tire valve.

12. Plug the compressor power cord into the vehicle power outlet.

13. Adjust the tire inflation pressure to the recommended tire inflation.

With the Vehicle is ON (**READY** indicator ON) proceed as follows.

- To increase the inflation pressure: Switch on the compressor. To check the current inflation pressure setting, briefly switch off the compressor.
- To reduce the inflation pressure: Press the button (9) on the compressor.

NOTICE

Do not let the compressor run for more than 10 minutes, otherwise the device will overheat and may be damaged.

i Information

The pressure gauge may show higher than actual reading when the compressor is running. To get an accurate tire reading, the compressor needs to be turned off.

CAUTION

If the inflation pressure is not maintained, drive the vehicle a second time, refer to the step 9.

Then repeat steps 10 to 13.

Use of the TMK may be ineffectual for tire damage larger than about 4 mm (0.16 in.).

We recommend that you contact an authorized HYUNDAI dealer if the tire cannot be made roadworthy with the Tire Mobility Kit.

⚠ WARNING

The tire inflation pressure must be at least 220 kPa (32 psi). If it is not, do not continue driving.

Call for road side service or towing.

⚠ CAUTION

Tire pressure sensor (if equipped with TPMS)

The sealant on the tire pressure sensor and wheel should be removed when you replace the tire with a new one and inspect the tire pressure sensors. We recommend that you get this done at an authorized HYUNDAI dealer.

***i* Information**

When reinstalling the repaired or replaced tire and wheel on the vehicle, tighten the wheel lug nut to 11-13 kgf-m (79-94 lbf-ft).

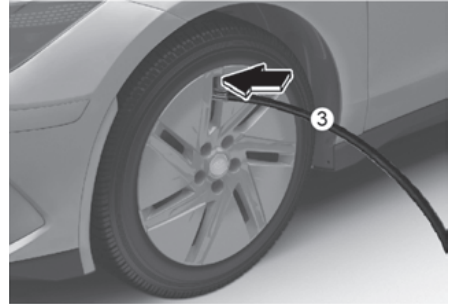
How to adjust tire pressure

1. Park your vehicle in a safe location.
2. Connect the filling hose (3) of the compressor directly to the tire valve.
3. Plug the compressor power cord into the vehicle power outlet.
4. Adjust the tire inflation pressure to the recommended tire inflation.

With the Vehicle is ON (**READY** indicator ON), proceed as follows.

- To increase the inflation pressure: Switch on the compressor. To check the current inflation pressure setting, briefly switch off the compressor.
- To reduce the inflation pressure: Press the button (9) on the compressor.

NOTICE

Do not let the compressor run for more than 10 minutes, otherwise the device will overheat and may be damaged.

i Information

- The pressure gauge may show higher than actual reading when the compressor is running. To get an accurate tire reading, the compressor needs to be turned off.
- When reinstalling the repaired or replaced tire and wheel on the vehicle, tighten the wheel lug nut to 11-13kgf-m (79-94 lbf-ft).

⚠ CAUTION

Do not use the sealant when the tire pressure only needs to be adjusted.

⚠ WARNING

The tire inflation pressure must be at least 220 kPa (32 psi). If it is not, do not continue driving.

Call for road side service or towing.

Towing

Towing service

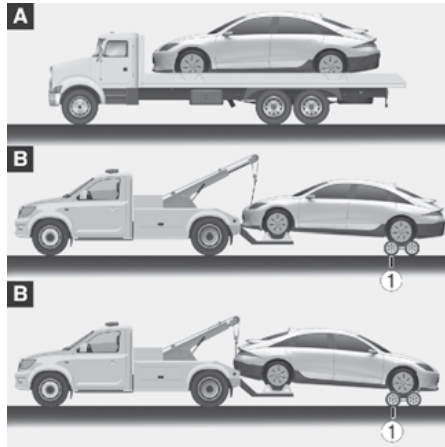

(1) Dollies

If emergency towing is necessary, we recommend having it done by an authorized HYUNDAI dealer or a commercial tow-truck service.

Proper lifting and towing procedures are necessary to prevent damage to the vehicle. The use of wheel dollies or flatbed is recommended.

For 2WD vehicles, it is acceptable to tow the vehicle with the front wheels on the ground (without dollies) and the rear wheels off the ground.

If any of the loaded wheels or suspension components are damaged or the vehicle is being towed with the rear wheels on the ground, use a towing dolly under the rear wheels.

When being towed by a commercial tow truck and wheel dollies are not used, the rear of the vehicle should always be lifted, not the front.

⚠ CAUTION

- Do not tow the vehicle with the rear wheels on the ground as this may cause damage to the vehicle.

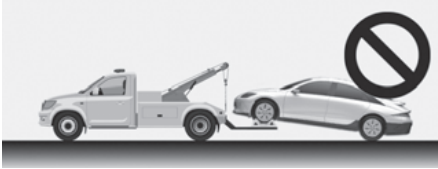

For AWD vehicles, it must be towed with a wheel lift and dollies or flatbed equipment with all the wheels off the ground.

Precautions when moving a short distance before towing a vehicle

Move short distances within 10 m (33 feet) at a speed of 5 km/h (3 mph) or less only when loading on a tow truck or if the vehicle needs to be repositioned.

At this time, the gear must be in the N (Neutral) position and the parking brake must be released. If it is impossible to operate the reduction gear and parking brake, move the vehicle with the rear wheel lifted.

NOTICE

Do not lift the vehicle by the tow fitting or body and chassis parts. Otherwise the vehicle may be damaged.

⚠ CAUTION

Do not tow with sling-type equipment. Use wheel lift or flatbed equipment.

**Removable towing hook**

- Open the trunk, and remove the towing hook from the tool case.
- Remove the hole cover.



3. Push the lower part of the bumper hole cover.

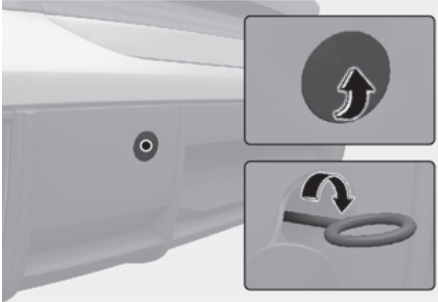

- Push the upper part of the bumper hole cover.
 - Pull the lower part of the bumper hole cover.
4. Install the towing hook by turning it clockwise into the hole until it is fully secured.
 5. Remove the towing hook and install the cover after use.

NOTICE

Failure to properly tighten the towing hook may result in vehicle damage and deformation of related parts.

CAUTION

Make sure the towing hook is tightened properly. If not, during towing the towing hook may be thrown off the vehicle resulting in serious injury or accident.

Emergency commodity

 If equipped

Your vehicle is equipped with emergency commodities to help you respond to emergency situation.

Fire extinguisher

NOTICE

This vehicle is equipped with the powder-type fire extinguisher exclusively for the fire caused by the electricity in the vehicle. Using water or other inappropriate fire extinguisher may cause the electric shock and collateral damage. If the fire cannot be controlled by the fire extinguisher equipped in the vehicle, avoid approaching to the fire and call fire station. Make sure to announce that the fire is caused by the electric vehicle.

If there is small fire and you know how to use the fire extinguisher, follow these steps carefully.

1. Pull out the safety pin at the top of the extinguisher that keeps the handle from being accidentally pressed.
2. Aim the nozzle towards the base of the fire.
3. Stand about 2.5 m (8 ft) away from the fire and squeeze the handle to discharge the extinguisher. If you release the handle, the discharge will stop.
4. Sweep the nozzle back and forth at the base of the fire. After the fire appears to be out, watch carefully since it may re-ignite.

First aid kit

Supplies for use in giving first aid such as scissors, bandage and adhesive tape, etc., are provided.

Triangle reflector

Place the triangle reflector on the road to warn oncoming vehicles during emergencies, such as when the vehicle is parked by the roadside due to problems.

Tire pressure gauge

 if equipped

Tires normally lose some air in day-to-day use, and you may have to add a air periodically and usually it is not a sign of a leaking tire, but of normal wear. Always check tire pressure when the tires are cold because tire pressure increases with temperature.

To check the tire pressure, take the following steps:

1. Unscrew the inflation valve cap that is located on the rim of the tire.
 2. Press and hold the gauge against the tire valve. Some air will leak as you begin and more will leak if you don't press the gauge in firmly.
 3. A firm non-leaking push will activate the gauge.
 4. Read the tire pressure on the gauge to see whether the tire pressure is low or high.
5. Adjust the tire pressure to the specified pressure. Refer to the "Tires and wheels" section in chapter 2.
 6. Reinstall the inflation valve cap.

WARNING

- When an accident occur, park the vehicle to a safe place. To avoid the leak of electricity in high voltage battery, turn the vehicle off and pull the yellow label in the high voltage battery switch to shut down the high voltage battery. Also, disconnect the auxiliary battery(12 V) cable to shut down. Be sure to disconnect both (+)cable and (-) cable.
- Do not touch the exposed electric wires. Do not touch high voltage wires (orange), connectors and other electric components.
- When an accident occur, the lethal gas and fluid from damaged high voltage battery can be leaked. Be aware not to touch or exposed to the gas and fluid. When flammable or poison gas leak inside the vehicle, open windows and evacuate to a safe place. When leaked fluid comes in contact with your eyes, flush your eyes with clean water. When the fluid contacts with your skin, wash it with salt water. Get immediate medical attention afterward.
- When the vehicle is flooded, immediately turn the vehicle off and evacuate to a safe place. For your safety we recommend to call the fire station and or contact an authorized HYUNDAI dealer.
- When the fire spread to the high voltage battery, the additional fire may occur. In this situation, be sure to accompany a fire truck when the vehicle is being towed.

Pan-European eCall System (For EUROPE)

 if equipped

The vehicle is equipped with a device* connected with the Pan-European eCall system for making emergency call to response teams. The Pan-European eCall system is an automatic emergency call service made in event of a traffic accident or other** accidents on the roads of Europe. (only in countries with regulation on this system)

The system allows contacting with an officer of the single duty dispatch service in case of accidents on the roads of Europe. (only in countries with regulation on this system)

The Pan-European eCall system given conditions, stated in the Owner's Manual as well as Warranty and Service book transmits data to the Public Safety Answering Point (PSAP) including such information as vehicle location, vehicle type, VIN (vehicle identification number of the vehicle).

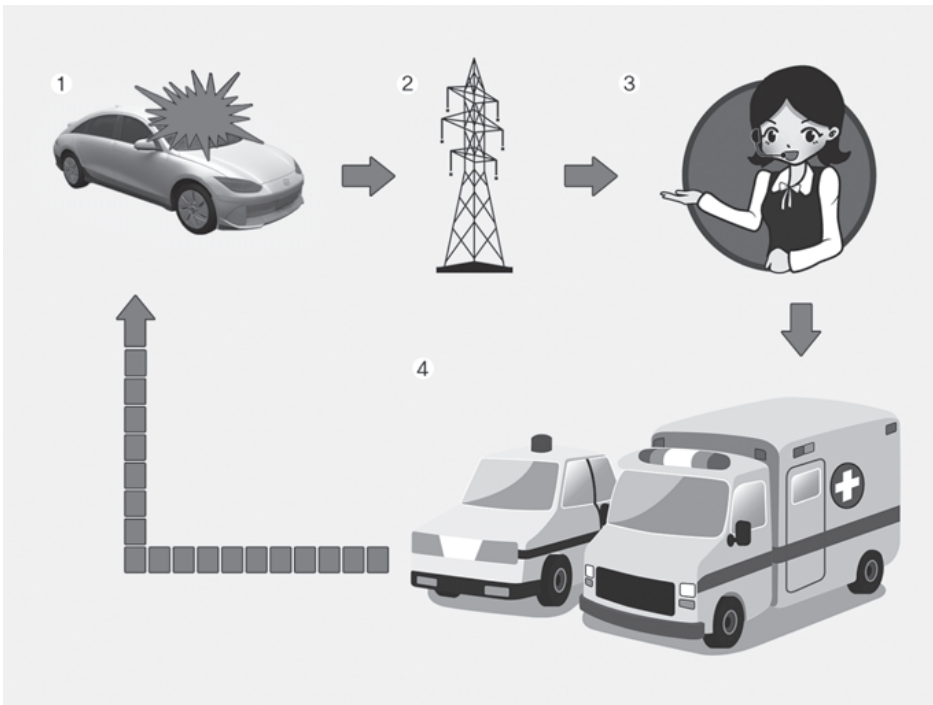

1. Road accident
2. Wireless network
3. Public Safety Answering Point (PSAP)
4. Rescue

i Information

Pan-European eCall device in the Owner's Manual means equipment, installed in the vehicle, which provides connection with the Pan-European eCall system.

"Other accidents" mean any accidents on the roads of Europe (only in countries with regulation on this system) resulted in injured people and/or necessity of provision of assistance. In case of registration of any accident, it is necessary to stop a vehicle, press button SOS (location of the button is specified on the picture in the chapter "Pan-European eCall (IF EQUIPPED)") of the Owner's Manual. When making a call, the system gathers information about the vehicle (from which a call was made), after which connects the car with an officer of the Public Safety Answering Point (PSAP) to tell about the reason of the emergency call.

Once the data which is stored in the Pan-European eCall system is delivered to the rescue center to assist the driver and passengers with proper rescue operations, the data will be deleted after rescue operation is completed.

Description of the eCall in-vehicle system (For Europe)

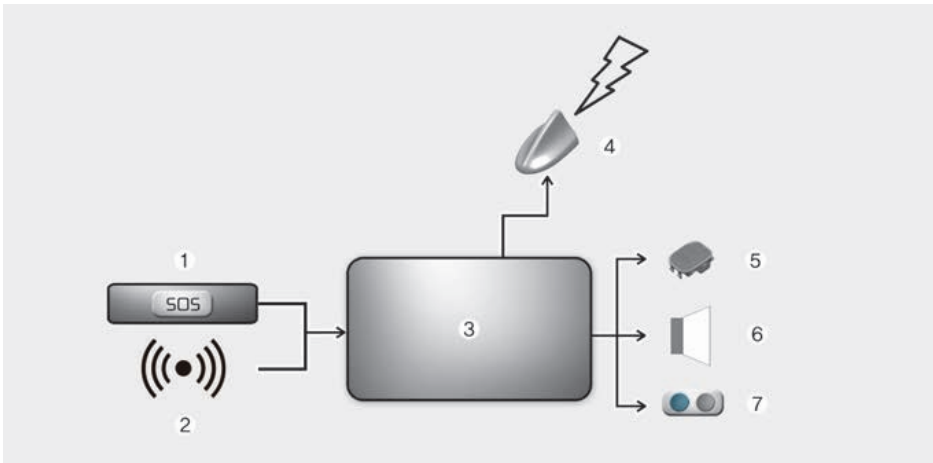

- (1) SOS Button
- (2) Crash signal
- (3) Emergency Call System
- (4) Antenna
- (5) Mic
- (6) Speaker
- (7) LEDs

Overview of the 112-based eCall in-vehicle system, its operation and functionalities: refer to this section. The 112-based eCall service is a public service of general interest and is accessible free of charge.

The 112-based eCall in-vehicle system is activated by default. It is activated automatically by means of in-vehicle sensors in the event of a severe accident.

It will also be triggered automatically when the vehicle is equipped with a TPS system which does not function in the event of a severe accident.

The 112-based eCall in-vehicle system can also be triggered manually, if needed. Instructions for manual activation of the system: refer to this section.

In the event of a critical system failure that would disable the 112-based eCall in-vehicle system, the following warning will be given to the occupants of the vehicle: refer to this section.

Information on data processing (For Europe)

Any processing of personal data through the 112-based eCall in-vehicle system shall comply with the personal data protection rules provided for in Directives 95/46/EC (1) and 2002/58/EC (2) of the European Parliament and of the Council, and in particular, shall be based on the necessity to protect the vital interests of the individuals in accordance with Article 7(d) of Directive 95/46/EC (3).

Processing of such data is strictly limited to the purpose of handling the emergency eCall to the single European emergency number 112.

Types of data and its recipients

The 112-based eCall in-vehicle system may collect and process only the following data:

- Vehicle Identification Number
- Vehicle type (passenger vehicle or light commercial vehicle)
- Vehicle propulsion storage type (gasoline/diesel/CNG/LPG/electric/hydrogen)
- Vehicle recent locations and direction of travel
- Log file of the automatic activation of the system and its timestamp
- Any additional data (if applicable): Not applicable

Recipients of data processed by the 112-based eCall in-vehicle system are the relevant public safety answering points designated by the respective public authorities of the country on which territory they are located, to first receive and handle eCalls to the single European emergency number 112. Additional information (if available): Not applicable

1. Directive 95/46/EC of the European Parliament and of the Council of 24 October 1995 on the protection of individuals with regard to the processing of personal data and on the free movement of such data (OJ L 281, 23.11.1995, p. 31).
2. Directive 2002/58/EC of the European Parliament and of the Council of 12 July 2002 concerning the processing of personal data and the protection of privacy in the electronic communications sector (Directive on privacy and electronic communications) (OJ L 201, 31.7.2002, p. 37).
3. Directive 95/46/EC is repealed by Regulation (EU) 2016/679 of the European Parliament and of the Council of 27 April 2016 on the protection of natural persons with regard to the processing of personal data and on the free movement of such data (General Data Protection Regulation) (OJ L 119, 4.5.2016, p. 1). The Regulation applies from 25 May 2018.

Arrangements for data processing

The 112-based eCall in-vehicle system is designed in such a way as to ensure that the data contained in the system memory is not available outside the system before an eCall is triggered. Additional remarks (if any): Not applicable

The 112-based eCall in-vehicle system is designed in such a way as to ensure that it is not traceable and not subject to any constant tracking in its normal operation status. Additional remarks (if any): Not applicable

The 112-based eCall in-vehicle system is designed in such a way as to ensure that data in the system internal memory is automatically and continuously removed.

The vehicle location data is constantly overwritten in the internal memory of the system so as always to keep maximum of the last three up-to-date locations of the vehicle necessary for the normal functioning of the system.

The log of activity data in the 112-based eCall in-vehicle system is kept for no longer than necessary for attaining the purpose of handling the emergency eCall and in any case not beyond 13 hours from the moment an emergency eCall was initiated. Additional remarks (if any): Not applicable

Modalities for exercising data subject's rights

The data subject (the vehicle's owner) has a right of access to data and as appropriate to request the rectification, erasure or blocking of data, concerning him or her, the processing of which does not comply with the provisions of Directive 95/46/EC. Any third parties to whom the data have been disclosed have to be notified of such rectification, erasure or blocking carried out in compliance with this Directive, unless it proves impossible or involves a disproportionate effort.

The data subject has a right to complain to the competent data protection authority if he or she considers that his or her rights have been infringed as a result of the processing of his or her personal data.

Contact service responsible for handling access requests (if any): Not applicable

Pan-European eCall System (For Europe)



Elements of the Pan-European eCall system, installed in passenger compartment:

- (1) SOS button
- (2) LED

SOS button: the driver/passenger makes an emergency call to the single duty dispatch service by pressing the button.

LED: The LED illuminates for 3 seconds when the Start/Stop button is in the ON position. After that they will switch off at normal operation of the system.

If there are some problems in the system, the SOS indicator light illuminates in the instrument cluster.

Automatic accident reporting (For Europe)

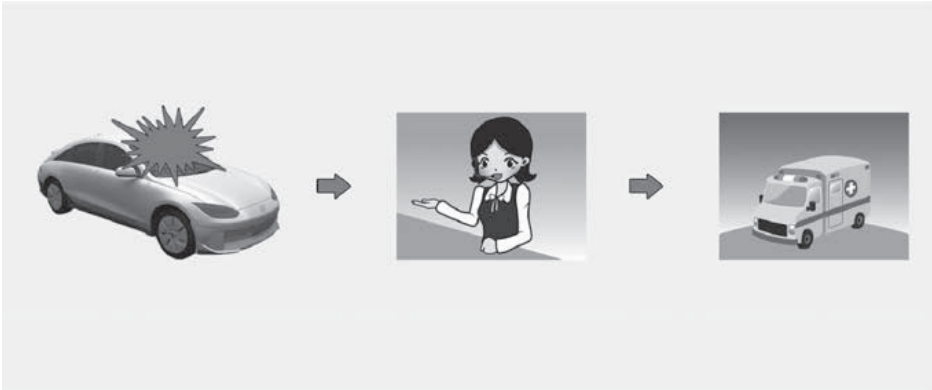

- (1) System operation in the event of a traffic accident
- (2) Connection with the Public Safety Answering Point (PSAP)
- (3) Emergency services

The Pan-European eCall device automatically makes an emergency call to the Public Safety Answering Point (PSAP) for proper rescuing operations in event of vehicle accident.

For proper emergency services and support the Pan-European eCall system automatically transmits the accident data to the Public Safety Answering Point (PSAP) when a traffic accident is detected.

In this case, the emergency call cannot be hung up by pressing the SOS button and the Pan-European eCall system remains connected until the emergency service officer, receiving the call, disconnects the emergency call.

In minor traffic accidents the Pan-European eCall system may not execute an emergency call. However, an emergency call may be made manually by pressing the SOS button.

CAUTION

Operation of the system is impossible in case of absence of mobile transmission and GPS and Galileo signals.

Manual accident reporting (For Europe)

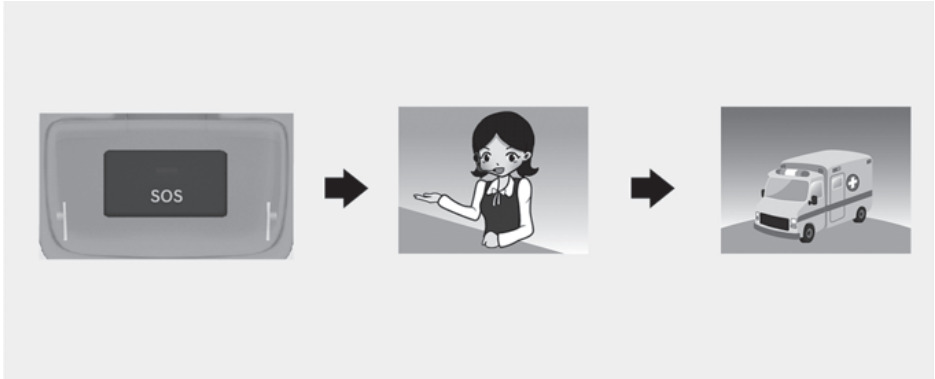

The driver or passenger manually can make an emergency call in the Public Safety Answering Point (PSAP), by pressing SOS button to call the necessary emergency services.

A call to the emergency services through the Pan-European eCall system can be cancelled by pressing the SOS button again only before the call connection.

After activation of emergency call in the manual mode (for proper emergency services and support), the Pan-European eCall system automatically transmits the road accident data / or data on other accident to the officer of the Public Safety Answering Point (PSAP) (during emergency call) by pressing the SOS button.

If the driver or passenger accidentally presses the SOS button, it can be canceled by pressing the button again. (For Russia)

It can be canceled by pressing the button again in 3 seconds. It can't be canceled after that. (Except Russia)

In case of road accident or other accident for activation of emergency call in manual mode it is necessary:

1. Stop the vehicle in accordance with traffic rules to ensure safety to yourself and other participants of road traffic;
2. Press the SOS button, when pressing the button SOS registration of the device in the wireless telephonic communication networks is carried out, minimum data set about vehicle and its location is collected in accordance with of the technical requirements of the device. After that connection with the officer of the Pan-European eCall system is made for clearing up reasons (conditions) of the emergency call.
3. After clearing up reasons of the emergency call, the officer of the Public Safety Answering Point (PSAP) sends emergency services and completes the emergency call.

If the emergency call is not carried out in accordance with the procedure, mentioned above, the emergency call will be considered as erroneous.

WARNING

Emergency power supply of the Pan-European eCall system from the battery

- The Pan-European eCall system battery supplies power during 1 hour in case main power source of the vehicle is cut off due to the collision during the emergency situations.
- The Pan-European eCall system battery should be replaced every 4 years. For more information refer to the "Scheduled maintenance services" section in chapter 9.

LED illumination in red (system malfunction)

If red LED illuminates in normal driving conditions, this can indicate malfunction of the Pan-European eCall system. We recommend to have the Pan-European eCall system checked at an authorized HYUNDAI dealer.

Otherwise correct operation of the Pan-European eCall system device, installed in your vehicle is not guaranteed. Owner of the vehicle incurs liability for consequences, occurred as a result of nonobservance of conditions, mentioned above.

Arbitrary Removal or Modification

The Pan-European eCall system calls emergency services for assistance. Thus, any arbitrary removal or changes to the Pan-European eCall system settings may affect your driving safety. Also, it may even make an erroneous emergency call to the Public Safety Answering Point (PSAP). Thereby, we kindly ask you not to make any changes by yourself or by the third parties in the settings of the equipment of the Pan-European eCall system, installed in your vehicle.

UAE eCall System (For UAE)

 if equipped

The vehicle is equipped with a device* connected with the UAE eCall system for making emergency call to response teams. The UAE eCall system is an automatic emergency call service made in event of a traffic accident or other** accidents on the roads. (only in countries with regulation on this system)

The system allows contacting with an officer of the single duty dispatch service in case of accidents on the roads. (only in countries with regulation on this system)

The UAE eCall system given conditions, stated in the Owner's Manual as well as Warranty and Service book transmits data to the Public Safety Answering Point (PSAP) including such information as vehicle location, vehicle type, VIN (vehicle identification number of the vehicle).

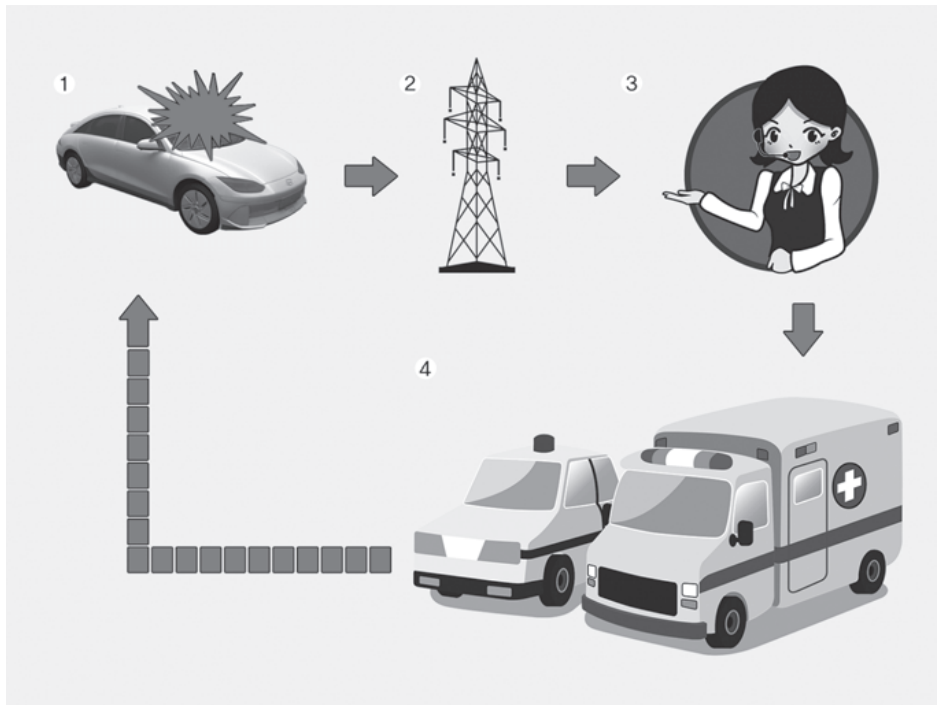

1. Road accident
2. Wireless network
3. Public Safety Answering Point (PSAP)
4. Rescue

i Information

UAE eCall device in the Owner's Manual means equipment, installed in the vehicle, which provides connection with the UAE eCall system.

"Other accidents" mean any accidents on the roads UAE (only in countries with regulation on this system) resulted in injured people and/or necessity of provision of assistance. In case of registration of any accident, it is necessary to stop a vehicle, press button SOS (location of the button is specified on the picture in the chapter "UAE eCall (IF EQUIPPED)") of the Owner's Manual. When making a call, the system gathers information about the vehicle (from which a call was made), after which connects the car with an officer of the Public Safety Answering Point (PSAP) to tell about the reason of the emergency call.

Once the data which is stored in the UAE eCall system is delivered to the rescue center to assist the driver and passengers with proper rescue operations, the data will be deleted after rescue operation is completed.

Description of the eCall in-vehicle system (For UAE)

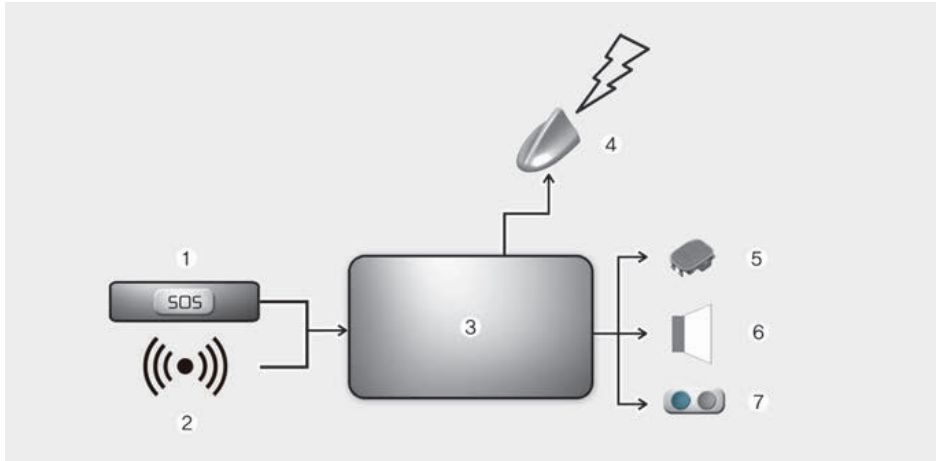

- (1) SOS Button
- (2) Crash signal
- (3) Emergency Call System
- (4) Antenna
- (5) Mic
- (6) Speaker
- (7) LEDs

Overview of the 999-based eCall in-vehicle system, its operation and functionalities: refer to this section. The 999-based eCall service is a public service of general interest and is accessible free of charge.

The 999-based eCall in-vehicle system is activated by default. It is activated automatically by means of in-vehicle sensors in the event of a severe accident.

It will also be triggered automatically when the vehicle is equipped with a TPS system which does not function in the event of a severe accident.

The 999-based eCall in-vehicle system can also be triggered manually, if needed. Instructions for manual activation of the system: refer to this section.

In the event of a critical system failure that would disable the 999-based eCall in-vehicle system, the following warning will be given to the occupants of the vehicle: refer to this section.

Information on data processing (For UAE)

Any processing of personal data through the 999-based eCall in-vehicle system shall comply with the personal data protection rules provided for in Directives 95/46/EC (1) and 2002/58/EC (2) of the European Parliament and of the Council, and in particular, shall be based on the necessity to protect the vital interests of the individuals in accordance with Article 7(d) of Directive 95/46/EC (3).

Processing of such data is strictly limited to the purpose of handling the emergency eCall to the single UAE emergency number 999.

Types of data and its recipients

The 999-based eCall in-vehicle system may collect and process only the following data:

- Vehicle Identification Number
- Vehicle type (passenger vehicle or light commercial vehicle)
- Vehicle propulsion storage type (gasoline/diesel/CNG/LPG/electric/hydrogen)
- Vehicle recent locations and direction of travel
- Log file of the automatic activation of the system and its time stamp
- Any additional data (if applicable): Not applicable

Recipients of data processed by the 999-based eCall in-vehicle system are the relevant public safety answering points designated by the respective public authorities of the country on which territory they are located, to first receive and handle eCalls to the single UAE emergency number 999. Additional information (if available): Not applicable

1. Directive 95/46/EC of the European Parliament and of the Council of 24 October 1995 on the protection of individuals with regard to the processing of personal data and on the free movement of such data (OJ L 281, 23.11.1995, p. 31).
2. Directive 2002/58/EC of the European Parliament and of the Council of 12 July 2002 concerning the processing of personal data and the protection of privacy in the electronic communications sector (Directive on privacy and electronic communications) (OJ L 201, 31.7.2002, p. 37).
3. Directive 95/46/EC is repealed by Regulation (EU) 2016/679 of the European Parliament and of the Council of 27 April 2016 on the protection of natural persons with regard to the processing of personal data and on the free movement of such data (General Data Protection Regulation) (OJ L 119, 4.5.2016, p. 1). The Regulation applies from 25 May 2018.

Arrangements for data processing

The 999-based eCall in-vehicle system is designed in such a way as to ensure that the data contained in the system memory is not available outside the system before an eCall is triggered. Additional remarks (if any): Not applicable

The 999-based eCall in-vehicle system is designed in such a way as to ensure that it is not traceable and not subject to any constant tracking in its normal operation status. Additional remarks (if any): Not applicable

The 999-based eCall in-vehicle system is designed in such a way as to ensure that data in the system internal memory is automatically and continuously removed.

The vehicle location data is constantly overwritten in the internal memory of the system so as always to keep maximum of the last three up-to-date locations of the vehicle necessary for the normal functioning of the system.

The log of activity data in the 999-based eCall in-vehicle system is kept for no longer than necessary for attaining the purpose of handling the emergency eCall and in any case not beyond 13 hours from the moment an emergency eCall was initiated. Additional remarks (if any): Not applicable

Modalities for exercising data subject's rights

The data subject (the vehicle's owner) has a right of access to data and as appropriate to request the rectification, erasure or blocking of data, concerning him or her, the processing of which does not comply with the provisions of Directive 95/46/EC. Any third parties to whom the data have been disclosed have to be notified of such rectification, erasure or blocking carried out in compliance with this Directive, unless it proves impossible or involves a disproportionate effort.

The data subject has a right to complain to the competent data protection authority if he or she considers that his or her rights have been infringed as a result of the processing of his or her personal data.

Contact service responsible for handling access requests (if any): Not applicable

UAE eCall System (For UAE)



Elements of the UAE eCall System,
installed in passenger compartment:

- (1) SOS button
- (2) LED

SOS button: the driver/passenger makes an emergency call to the single duty dispatch service by pressing the button.

LED: The LED illuminates for 3 seconds when the Start/Stop button is in the ON position. After that they will switch off at normal operation of the system.

If there are some problems in the system, the SOS indicator light illuminates in the instrument cluster.

Automatic accident reporting (For UAE)

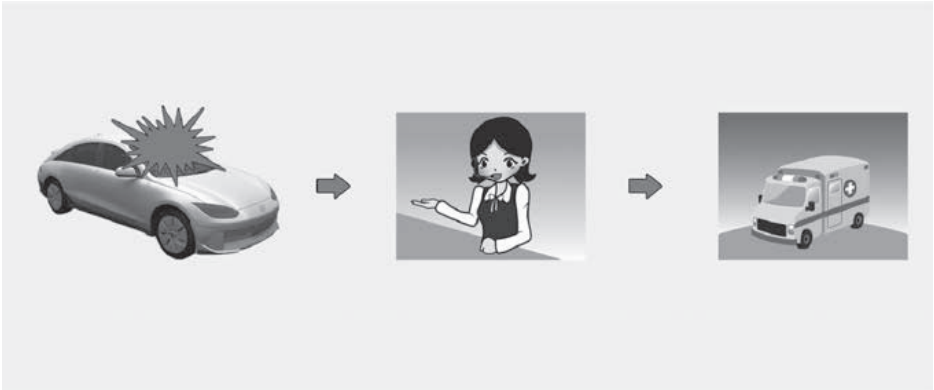

The UAE eCall device automatically makes an emergency call to the Public Safety Answering Point (PSAP) for proper rescuing operations in event of vehicle accident.

For proper emergency services and support the UAE eCall system automatically transmits the accident data to the Public Safety Answering Point (PSAP) when a traffic accident is detected.

In this case, the emergency call cannot be hung up by pressing the SOS button and the UAE eCall system remains connected until the emergency service officer, receiving the call, disconnects the emergency call.

In minor traffic accidents the UAE eCall system may not execute an emergency call. However, an emergency call may be made manually by pressing the SOS button.

⚠ CAUTION

Operation of the system is impossible in case of absence of mobile transmission and GPS and Galileo signals.

Manual accident reporting

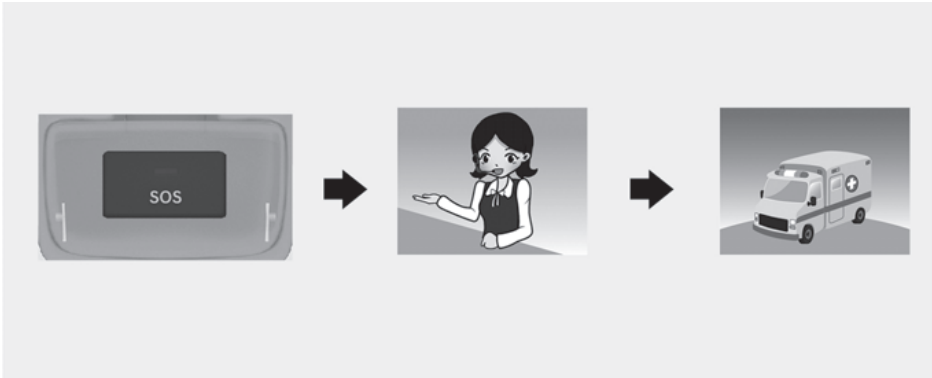

The driver or passenger manually can make an emergency call in the Public Safety Answering Point (PSAP), by pressing SOS button to call the necessary emergency services.

A call to the emergency services through the UAE eCall system can be cancelled by pressing the SOS button again only before the call connection.

After activation of emergency call in the manual mode (for proper emergency services and support), the UAE eCall system automatically transmits the road accident data / or data on other accident to the officer of the Public Safety Answering Point (PSAP) (during emergency call) by pressing the SOS button.

If the driver or passenger accidentally presses the SOS button, it can be canceled by pressing the button again. (For Russia)

It can be canceled by pressing the button again in 3 seconds. It can't be canceled after that. (Except Russia)

In case of road accident or other accident for activation of emergency call in manual mode it is necessary:

1. Stop the vehicle in accordance with traffic rules to ensure safety to yourself and other participants of road traffic;
2. Press the SOS button, when pressing the button SOS registration of the device in the wireless telephonic communication networks is carried out, minimum data set about vehicle and its location is collected in accordance with of the technical requirements of the device. After that connection with the officer of the UAE eCall system is made for clearing up reasons (conditions) of the emergency call.
3. After clearing up reasons of the emergency call, the officer of the Public Safety Answering Point (PSAP) sends emergency services and completes the emergency call.

If the emergency call is not carried out in accordance with the procedure, mentioned above, the emergency call will be considered as erroneous.

WARNING

Emergency power supply of the UAE eCall system from the battery

- The UAE eCall system battery supplies power during 1 hour in case main power source of the vehicle is cut off due to the collision during the emergency situations.
- The UAE eCall system battery should be replaced every 4 years. For more information refer to the "Scheduled maintenance services" section in chapter 9.

LED illumination in red (system malfunction)

If red LED illuminates in normal driving conditions, this can indicate malfunction of the UAE eCall system. We recommend to have the UAE eCall system checked at an authorized HYUNDAI dealer.

Otherwise correct operation of the UAE eCall system device, installed in your vehicle is not guaranteed. Owner of the vehicle incurs liability for consequences, occurred as a result of nonobservance of conditions, mentioned above.

Arbitrary Removal or Modification

The UAE eCall system calls emergency services for assistance. Thus, any arbitrary removal or changes to the UAE eCall system settings may affect your driving safety. Also, it may even make an erroneous emergency call to the Public Safety Answering Point (PSAP). Thereby, we kindly ask you not to make any changes by yourself or by the third parties in the settings of the equipment of the UAE eCall system, installed in your vehicle.

eCall certification label



9. Maintenance

Motor compartment.....	9-3
Maintenance services	9-4
Owner's responsibility	9-4
Owner maintenance precautions	9-4
Owner maintenance.....	9-5
Owner maintenance schedule	9-5
Scheduled maintenance services.....	9-7
Normal maintenance schedule.....	9-8
Normal maintenance schedule.....	9-9
Maintenance under severe usage conditions.....	9-10
Explanation of scheduled maintenance items	9-11
Cooling system.....	9-11
Coolant	9-11
Reduction gear fluid	9-11
Brake hoses and lines	9-11
Brake fluid.....	9-11
Brake discs, pads, calipers and rotors.....	9-11
Suspension mounting bolts.....	9-11
Steering gear box, linkage & boots/lower arm ball joint.....	9-11
Drive shafts and boots.....	9-11
Air conditioning refrigerant.....	9-11
Coolant	9-12
Brake fluid	9-13
Checking the brake fluid level.....	9-13
Reduction gear fluid	9-14
Washer fluid	9-14
Checking the washer fluid level.....	9-14
Cabin air filter.....	9-15
Filter inspection	9-15
Filter replacement.....	9-15
Wiper blades	9-16
Blade inspection	9-16
Blade replacement.....	9-16
Battery (12 V).....	9-18
For best battery service.....	9-20

Battery capacity label	9-21
Battery recharging	9-21
Reset items	9-22
Tires and wheels.....	9-23
Tire care	9-23
Recommended cold tire inflation pressures	9-23
Check tire inflation pressure.....	9-24
Tire rotation	9-25
Wheel alignment and tire balance	9-25
Tire replacement	9-26
Wheel replacement	9-26
Tire traction.....	9-27
Tire maintenance.....	9-27
Tire sidewall labeling.....	9-27
Low aspect ratio tires.....	9-30
Fuses.....	9-31
Instrument panel fuse replacement.....	9-32
Motor compartment panel fuse replacement.....	9-33
Fuse/relay panel description	9-35
Light bulbs	9-47
Headlight, position light, turn signal light, Daytime Running Light (DRL) replacement	9-48
Side repeater light replacement.....	9-49
Headlight aiming (For Europe)	9-49
Rear combination light replacement	9-56
High mounted stop light replacement	9-56
License plate light replacement	9-57
Front trunk light replacement	9-57
Interior light replacement.....	9-57
Appearance care	9-59
Exterior care.....	9-59
Interior care	9-64

Motor compartment



The actual motor compartment in the vehicle may differ from the illustration.

- (1) Coolant reservoir
- (2) Windshield washer fluid reservoir
- (3) Brake fluid reservoir
- (4) Fuse box
- (5) Battery (12 V)
- (6) Front trunk
- (7) Climate control system air filter

Maintenance services

You should exercise the utmost care to prevent damage to your vehicle and injury to yourself whenever performing any maintenance or inspection procedures.

We recommend you have your vehicle maintained and repaired by an authorized HYUNDAI dealer. An authorized HYUNDAI dealer meets HYUNDAI's high service quality standards and receives technical support from HYUNDAI in order to provide you with a high level of service satisfaction.

Owner's responsibility

Maintenance service and record retention are the owner's responsibility.

You should retain documents that show proper maintenance has been performed on your vehicle in accordance with the scheduled maintenance service charts shown on the following pages. You need this information to establish your compliance with the servicing and maintenance requirements of your vehicle warranties.

Detailed warranty information is provided in your Service Passport.

Repairs and adjustments required as a result of improper maintenance or a lack of required maintenance are not covered.

Owner maintenance precautions

Inadequate, incomplete or insufficient servicing may result in operational problems with your vehicle that could lead to vehicle damage, an accident, or personal injury. This chapter provides instructions only for the maintenance items that are easy to perform.

Your vehicle should not be modified in any way. Such modifications may adversely affect the performance, safety or durability of your vehicle and may, in addition, violate conditions of the limited warranties covering the vehicle.

NOTICE

Improper owner maintenance during the warranty period may affect warranty coverage. For more information, read the separate Service Passport provided with the vehicle. If you're unsure about any service or maintenance procedure, we recommend to have it done by an authorized HYUNDAI dealer.

Owner maintenance

WARNING

Performing maintenance work on a vehicle can be dangerous. If you lack sufficient knowledge and experience or the proper tools and equipment to do the work, we recommend that it is done by an authorized HYUNDAI dealer. ALWAYS follow these precautions for performing maintenance work:

- Park your vehicle on level ground. Shift the vehicle to P (Park), apply the parking brake, and press the Start/Stop button to the OFF position.
- Block the tires (front and back) to prevent the vehicle from moving.
Remove loose clothing or jewelry that can become entangled in moving parts.
- Keep flames, sparks, or smoking materials away from the battery parts.

WARNING

Make sure to turn the Start/Stop button to the OFF position to shut down the vehicle before performing maintenance work on the vehicle.

The following lists are vehicle checks and inspections that should be performed by the owner or an authorized HYUNDAI dealer at the frequencies indicated to help ensure safe, dependable operation of your vehicle.

Any adverse conditions should be brought to the attention of your dealer as soon as possible.

These Owner Maintenance vehicle checks are generally not covered by warranties and you may be charged for labor, parts and lubricants used.

The electric control system in the vehicle may cause malfunction or other negative impact on the artificial heart and the artificial internal organs. Be sure to inquire the impact of the electric control system on the artificial organs from the medical product corporation.

Owner maintenance schedule

When you stop for charging:

- Check the coolant level in the coolant reservoir.
- Check the windshield washer fluid level.
- Check for low or under-inflated tires.

WARNING

Be careful when checking your coolant level if the motor compartment is hot. This may result in coolant being blown out of the opening and cause serious burns and other injuries.

While operating your vehicle:

- Check for vibrations in the steering wheel. Notice if there is any increased steering effort or looseness in the steering wheel, or change in its straight-ahead position.
- Notice if your vehicle constantly turns slightly or "pulls" to one side when traveling on smooth, level road.
- When stopping, listen and check for unusual sounds, pulling to one side, increased brake pedal travel or "hard-to-push" brake pedal.
- If any slipping or changes in the operation of your gear shift occurs, check the shift gear fluid level.
- Check the shift gear P (Park) function.
- Check the parking brake.
- Check for fluid leaks under your vehicle (water dripping from the air conditioning system during or after use is normal).

At least monthly:

- Check coolant level in the coolant reservoir.
- Check the operation of all exterior lights, including the stoplights, turn signals and hazard warning flashers.
- Check the inflation pressures of all tires including the spare for tires that are worn, show uneven wear, or are damaged.
- Check for loose wheel lug nuts.

At least twice a year: (for example, every Spring and Autumn)

- Check radiator, heater and air conditioning hoses for leaks or damage.
- Check windshield washer spray and wiper operation. Clean wiper blades with a clean cloth dampened with washer fluid.
- Check headlight alignment.
- Check the seat belts for wear and function.

At least once a year:

- Clean body and door drain holes.
- Lubricate door hinges and hood hinges.
- Lubricate door and hood locks and latches.
- Lubricate door rubber weather strips.
- Check the air conditioning system.
- Inspect and lubricate shift gear linkage and controls.
- Clean the battery (12 V) and terminals.
- Check the brake fluid level.

Scheduled maintenance services

Follow Normal Maintenance Schedule if the vehicle is usually operated where none of the following conditions apply. If any of the following conditions apply, you must follow the Maintenance Under Severe Usage Conditions.

- Repeated driving short distance of less than 8 km (5 mi.) in normal temperature or less than 16 km (10mi.) in freezing temperature
- Driving on rough, dusty, muddy, unpaved, graveled or salt-spread roads
- Driving in areas using salt or other corrosive materials or in very cold weather
- Driving in heavy dust conditions
- Driving in heavy traffic area
- Driving in heavy traffic area with the ambient temperature higher than 32 °C (90 °F) while consuming more than 50 % of electric energy.
- Towing a trailer or using a camper, or driving with loads on the roof
- Driving as a patrol car, taxi, other commercial use of vehicle towing
- Frequently driving under high speed or rapid acceleration/deceleration
- Frequently driving in stop-and-go condition

If your vehicle is operated under the above conditions, you should inspect, replace or refill more frequently than the following Normal Maintenance Schedule. After the periods or distance shown in the chart, continue to follow the prescribed maintenance intervals.

Normal maintenance schedule

The following maintenance services must be performed to ensure good vehicle performance.

Keep receipts for all vehicle services to protect your warranty. Where both mileage and time are shown, the frequency of service is determined by whichever occurs first.

MAINTENANCE INTERVALS	Number of months or driving distance, whichever comes first									
	Months	24	48	72	96	120	144	168	192	
	Mi.×1,000	20	40	60	80	100	120	140	160	
	Km×1,000	30	60	90	120	150	180	210	240	
MAINTENANCE ITEM										
Cooling system										
Coolant *1	Standard	At first, replace at 200,000 km (125,000 mi.) or 10 years; after that, replace every 40,000 km (25,000 mi.) or 24 months.								
Reduction gear fluid										
12V auxiliary battery condition	For Europe									
	Except Europe	Inspect 15,000 km (10,000 mi.) or 12 months								
All electrical system										
Brake lines, hoses and connections										
Brake pedal										
Parking brake										
Brake fluid		R	R	R	R	R	R	R	R	
Brake discs and pads										

*1 When replacing or adding coolant, we recommend that you visit an authorized HYUNDAI dealer.

I: Inspect and if necessary, adjust, correct, clean or replace.

R: Replace or change.

Normal maintenance schedule

MAINTENANCE INTERVALS	Number of months or driving distance, whichever comes first								
	Months	24	48	72	96	120	144	168	192
	Mi.×1,000	20	40	60	80	100	120	140	160
	Km×1,000	30	60	90	120	150	180	210	240
MAINTENANCE ITEM									
Steering gear rack, linkage and boots	I	I	I	I	I	I	I	I	I
Driveshaft and boots	I	I	I	I	I	I	I	I	I
Tire (pressure & tread wear)	I	I	I	I	I	I	I	I	I
Front suspension ball joints	I	I	I	I	I	I	I	I	I
Bolt and nuts on chassis and body	I	I	I	I	I	I	I	I	I
Air conditioner refrigerant	I	I	I	I	I	I	I	I	I
Air conditioner compressor	I	I	I	I	I	I	I	I	I
Cabin air filter	For Europe	R	R	R	R	R	R	R	R
	Except Europe	Replace 15,000 km (10,000 mi.)							
Pan-European eCall system battery (if equipped)/ UAE eCall system battery (if equipped)	Replace every 4 years								

I: Inspect and if necessary, adjust, correct, clean or replace.

R: Replace or change.

Maintenance under severe usage conditions

The following items must be serviced more frequently on cars mainly used under severe driving conditions.

Refer to the chart below for the appropriate maintenance intervals.

R: Replace

I: Inspect and if necessary, adjust, correct, clean or replace

Maintenance item	Maintenance operation	Maintenance intervals	Driving condition
Reduction gear fluid	R	Every 120,000 km (80,000 mi.)	A, B, E, F, H, J
Steering gear rack, linkage and boots	I	Inspect more frequently depending on the condition	C, D, E, F, G
Front suspension ball joints	I	Inspect more frequently depending on the condition	B, C, D, E, F
Disc brakes and pads, calipers and rotors	I	Inspect more frequently depending on the condition	B, C, D, E, F, G, H, I, J
Driveshaft and boots	I	Inspect more frequently depending on the condition	B, C, D, E, F, G, H, I
Cabin air filter	R	Replace more frequently depending on the condition	B, D, F

Severe driving conditions

- A. Repeatedly driving short distance of less than 8 km (5 mi.) in normal temperature or less than 16 km (10 mi.) in freezing temperature
- B. Driving on rough, dusty, muddy, unpaved, graveled or salt spread roads
- C. Driving in areas using salt or other corrosive materials or in very cold weather
- D. Driving in heavy dust condition
- E. Driving in heavy traffic area with the ambient temperature higher than 32 °C (90 °F) while consuming more than 50 % of electric energy.
- F. Driving on uphill, downhill, or mountain roads repeatedly
- G. Towing a trailer, or using a camper or roof rack
- H. Driving as a patrol car, taxi, other commercial use or vehicle towing
- I. Frequently driving under high speed or rapid acceleration/deceleration
- J. Frequently driving in stop-and-go conditions

Explanation of scheduled maintenance items

Cooling system

Check cooling system components, such as radiator, coolant reservoir, hoses and connections for leakage and damage. Replace any damaged parts.

Coolant

The coolant should be changed at the intervals specified in the maintenance schedule.

Reduction gear fluid

The reduction gear fluid should be inspected according to the intervals specified in the maintenance schedule.

Brake hoses and lines

Visually check for proper installation, chafing, cracks, deterioration and any leakage. Replace any deteriorated or damaged parts immediately.

Brake fluid

Check the brake fluid level in the brake fluid reservoir. The level should be between the MIN and the MAX marks on the side of the reservoir. Use only hydraulic brake fluid conforming to DOT 4 specification.

Brake discs, pads, calipers and rotors

Check the pads, the disc, and the rotor for any excessive wear-out. Inspect calipers for any fluid leakage.

For more information on checking the pads or lining wear limit, visit <http://service.hyundai-motor.com>

Suspension mounting bolts

Check the suspension connections for looseness or damage. Retighten to the specified torque.

Steering gear box, linkage & boots/lower arm ball joint

With the vehicle stopped and the vehicle off, check for excessive free-play in the steering wheel. Check the linkage for bends or damage. Check the dust boots and ball joints for deterioration, cracks, or damage.

Replace any damaged parts.

Drive shafts and boots

Check the drive shafts, boots and clamps for cracks, deterioration, or damage. Replace any damaged parts and, if necessary, repack the grease.

Air conditioning refrigerant

Check the air conditioning lines and connections for leakage and damage.

Coolant

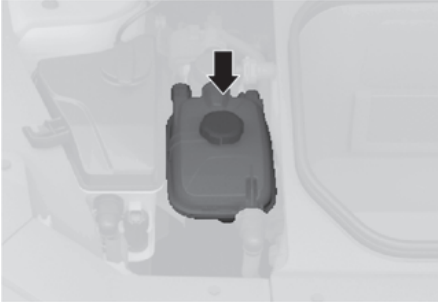

Check the condition and connections of all cooling system hoses and heater hoses. Replace any swollen or deteriorated hoses.

The coolant level should be filled between the MAX or F and the MIN or L marks on the side of the coolant reservoir when the parts in the motor compartment is cool.

If the coolant is low, we recommend to have the vehicle inspected by an authorized HYUNDAI dealer.

Use only designated coolant water for electric vehicles, adding other types of water or antifreeze can damage the vehicle.

WARNING



The electric motor for the cooling fan may continue to operate or start up when the vehicle is not running and can cause serious injury. Keep hands, clothing and tools away from the rotating fan blades of the cooling fan.

The electric motor for the cooling fan is controlled by vehicle coolant temperature, refrigerant pressure and vehicle speed. As the vehicle coolant temperature decreases, the electric motor will automatically shut off. This is a normal condition.

Brake fluid

Checking the brake fluid level

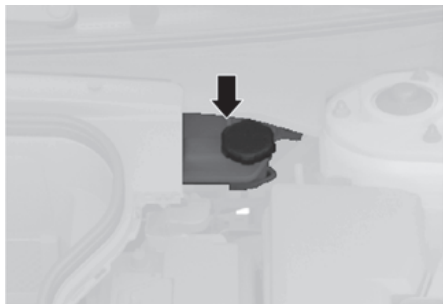

Check the fluid level in the reservoir periodically. The fluid level should be between MAX and MIN marks on the side of the reservoir.

Before removing the reservoir cap and adding brake fluid, clean the area around the reservoir cap thoroughly to prevent brake fluid contamination.

If the level is low, add the specified brake fluid to the MAX level. The level will fall with accumulated kilometers. This is a normal condition associated with the wear of the brake linings. If the fluid level is excessively low, we recommend that the brake system be checked by an authorized HYUNDAI dealer.

WARNING

If the brake system requires frequent additions of fluid this could indicate a leak in the brake system. We recommend that the vehicle be inspected by an authorized HYUNDAI dealer.

WARNING

Do not let brake fluid enter into your eyes. If brake fluid gets in your eyes, flush your eyes with clean water for at least 15 minutes and get immediate medical attention.

NOTICE

- Do not allow brake fluid to contact the vehicle's body paint, as it will result in paint damage.
- NEVER use brake fluid which has been exposed to open air for an extended time, as its quality cannot be guaranteed. It should be disposed of properly.
- Do not use the wrong type of brake fluid. A few drops of mineral based oil in your brake system can damage brake system parts.

Information

Use only the specified brake fluid (refer to the "Recommended lubricants and capacities" section in chapter 2).

Reduction gear fluid

There is no reduction gear fluid level gauge in the vehicle. Check the reduction gear fluid every 60,000 km regularly. If the vehicle is driven under severe condition, we recommend that you check the maintenance under severe usage condition and consult an authorized HYUNDAI dealer.

Washer fluid

Checking the washer fluid level

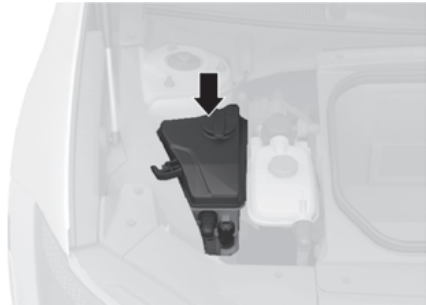

Check the fluid level in the washer fluid reservoir and add fluid if necessary. Plain water may be used if washer fluid is not available. However, use washer solvent with antifreeze characteristics in cold climates to prevent freezing.

WARNING

To prevent serious injury or death, take the following safety precautions when using washer fluid:

- Do not use coolant or antifreeze in the washer fluid reservoir. Coolant can severely obscure visibility when sprayed on the windshield and may cause loss of vehicle control resulting in an accident or damage to paint and body trim.
 - Do not allow sparks or flame to contact the washer fluid or the washer fluid reservoir. Washer fluid may contain alcohol and can be flammable.
 - Do not drink washer fluid and avoid contact with skin. Washer fluid is harmful to humans and animals.
 - Keep washer fluid away from children and animals.
-

Cabin air filter

Filter inspection

The cabin air filter should be replaced according to the Maintenance Schedule. If the vehicle is operated in severely air-polluted cities or on dusty rough roads for a long period, it should be inspected more frequently and replaced sooner. Replace the cabin air filter by following the procedure below and be careful to avoid damaging other components.

Filter replacement

1. Open the hood.
2. Lift up the front trunk cover while depressing the front trunk lever (1).

Type A



Type B



3. Press and hold the lock (2) on the left side of the cover (3).

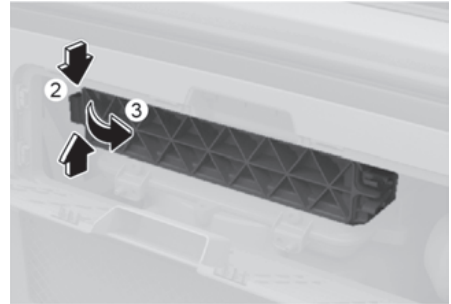

4. Replace the cabin air filter.
5. Reassemble in the reverse order of disassembly.



- Install a new cabin air filter in the correct direction with the arrow symbol (↓) facing downwards, to prevent noise and reduce effectiveness.
- Always be sure that the front trunk cover is firmly closed after replacing the cabin air filter.

Otherwise it may cause interior damage in the motor compartment, noise trouble, or entrance of foreign substances.

Wiper blades

Blade inspection

Contamination of either the windshield or the wiper blades with foreign matter can reduce the effectiveness of the windshield wipers.

Common sources of contamination are insects, tree sap, and hot wax treatments used by some commercial car washes. If the blades are not wiping properly, clean both the window and the blades with a good cleaner or mild detergent, and rinse thoroughly with clean water.

NOTICE

To prevent damage to the wiper blades, arms or other components, do not:

- Use gasoline, kerosene, paint thinner, or other solvents on or near them.
- Attempt to move the wipers manually.
- Use non-specified wiper blades.

i Information

Commercial hot waxes applied by automatic car washes have been known to make the windshield difficult to clean.

i Information

Wiper blades are consumable items. Normal wear of the wipers may not be covered by your vehicle warranty.

Blade replacement

When the wipers no longer clean adequately, the blades may be worn or cracked, and require replacement.

NOTICE

- In order to prevent damage to the hood and the wiper arms, the wiper arms should only be lifted when in the top wiping position.
- Always return the wiper arms to the windshield before driving.

Front windshield wiper blade replacement

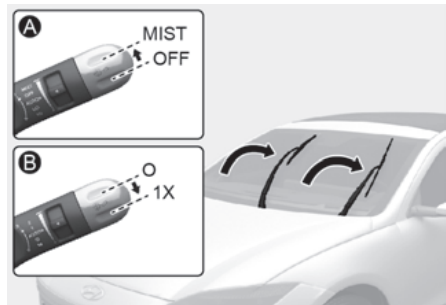

[A] Type A
[B] Type B

Within 20 seconds of turning off the vehicle, lift up (or push down) and hold the wiper lever to the MIST (or 1x) position for about 2 seconds until the wipers move to the top wipe position.

At this time you can lift the wipers off the windshield.

Type A

1. Lift up the wiper blade clip. Then lift up the wiper blade.

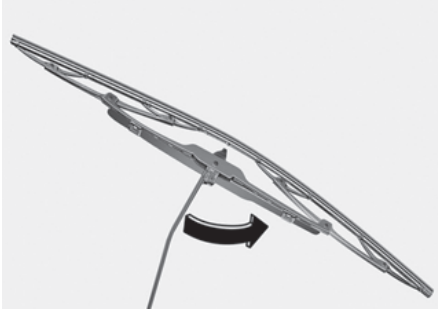

2. While pushing the lock (1), pull down the wiper blade (2).

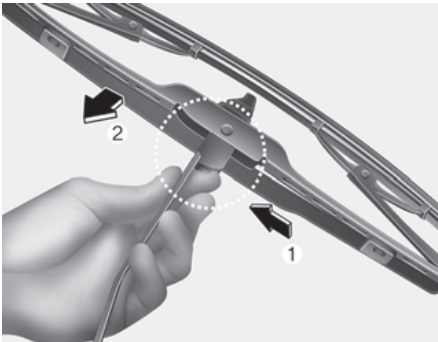

3. Remove the wiper blade from the wiper arm.



4. Install a new wiper blade assembly in the reverse order of removal.
5. Return the wiper arm on the windshield.

Type B

1. Lift up the wiper blade clip (1). Then lift up the wiper blade.

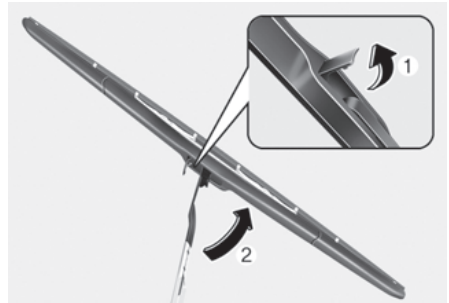

2. Press the clip (3). Then push the blade forward through the wiper arm to disassemble it (4).

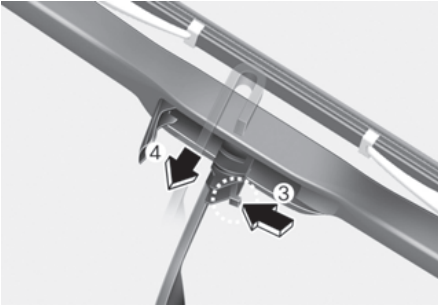

3. Remove the wiper blade from the wiper arm (5).



4. Install the new blade assembly in the reverse order of removal.
5. Return the wiper arm on the windshield.

Battery (12 V)

WARNING

To prevent **SERIOUS INJURY** or **DEATH** to you or bystanders, always follow these precautions when working near or handling the battery:



Always read and follow instructions carefully when handling a battery.



Wear eye protection designed to protect the eyes from acid splashes.



Keep all flames, sparks, or smoking materials away from the battery.



Hydrogen is always present in battery cells, is highly combustible, and may explode if ignited.



Keep batteries out of reach of children.



Batteries contain sulfuric acid which is highly corrosive. Do not allow acid to contact your eyes, skin or clothing.

If acid gets into your eyes, flush your eyes with clean water for at least 15 minutes and get immediate medical attention. If acid gets on your skin, thoroughly wash the area. If you feel pain or a burning sensation, get medical attention immediately.

- When lifting a plastic-cased battery, excessive pressure on the case may cause battery acid to leak. Lift with a battery carrier or with your hands on opposite corners.
 - Do not attempt to jump start your vehicle if your battery is frozen.
 - NEVER attempt to recharge the battery when the vehicle's battery cables are connected to the battery.
 - The electrical ignition switch works with high voltage. NEVER touch these components with the **READY** indicator ON or when the Start/Stop button is in the ON position.
-

NOTICE

Always follow these instructions when handling your vehicle's battery to prevent damage to your battery:

- When you do not use the vehicle for a long time in a low temperature area, disconnect the battery and keep it indoors.
 - Always charge the battery fully to prevent battery case damage in low temperature areas.
 - Prevent liquid from wetting the battery terminals. The performance of the battery may be degraded, and may cause injury. Be cautious when loading liquid in the trunk.
 - Do not tilt the battery.
 - If you connect unauthorized electronic devices to the battery, the battery may be discharged. Never use unauthorized devices.
-

For best battery service

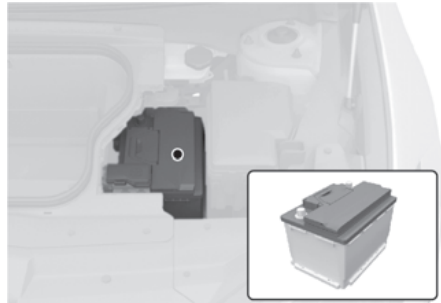

- Keep the battery securely mounted.
- Keep the battery top clean and dry.
- Keep the terminals and connections clean, tight, and coated with petroleum jelly or terminal grease.
- Rinse any spilled electrolyte from the battery immediately with a solution of water and baking soda.
- If the vehicle is not going to be used for an extended time, disconnect the battery cables.

Battery capacity label



i Information

The actual battery label in the vehicle may differ from the illustration.

1. CMF60L-DIN (12 V): The HYUNDAI model name of battery
2. 60Ah (20HR): The nominal capacity (in Ampere hours)
3. 550A: The cold-test current in amperes by SAE / EN
4. RC 92min: The nominal reserve capacity (in min.)

Battery recharging

By battery charger

Your vehicle has a maintenance-free, calcium-based battery.

- If the battery becomes discharged over a short time (because, for example, the headlights or interior lights were left on while the vehicle was not in use), recharge it by slow charging (trickle) for 10 hours.

- If the battery gradually discharges because of high electrical load while the vehicle is being used, recharge it at 20-30 A for two hours.

! WARNING

Always follow these instructions when recharging your vehicle's battery to avoid the risk of **SERIOUS INJURY** or **DEATH** from explosions or acid burns:

- Before performing maintenance or recharging the battery, turn off all accessories and stop the vehicle.
- Keep all flames, sparks, or smoking materials away from the battery.
- Always work outdoors or in an area with plenty of ventilation.
- Wear eye protection when checking the battery during charging.
- The battery must be removed from the vehicle and placed in a well ventilated area.
- Watch the battery during charging, and stop or reduce the charging rate if the battery cells begin boiling violently.
- The negative battery cable must be removed first and installed last when the battery is disconnected. Disconnect the battery charger in the following order:
 1. Turn off the battery charger main switch.
 2. Unhook the negative clamp from the negative battery terminal.
 3. Unhook the positive clamp from the positive battery terminal.
- We recommend that you use batteries for replacement from an authorized HYUNDAI dealer.

By jump starting

After a jump start from a good battery, drive the vehicle for 20-30 minutes before it is shutoff. The vehicle may not restart if you shut it off before the battery had a chance to adequately recharge. See "Jump starting (12 V battery)" in chapter 8 for more information on jump starting procedures.

***i* Information**



An inappropriately disposed battery can be harmful to the environment and human health. Dispose of the battery according to your local law(s) or regulation.

Reset items

The following items may need to be reset after the battery has been discharged or the battery has been disconnected.

- Drive info/After Recharging/Accumulated info (items in View modes) (see chapter 4)
- Integrated memory system (see chapter 5)
- Power windows (see chapter 5)
- Wide sunroof (see chapter 5)
- Power trunk (see chapter 5)
- Automatic climate control system (see chapter 5)
- Clock (see Infotainment system manual)
- Infotainment system (see Infotainment system manual)

Tires and wheels

WARNING

Tire failure may cause loss of vehicle control resulting in an accident. To reduce risk of SERIOUS INJURY or DEATH, take the following precautions:

- Inspect your tires monthly for proper inflation as well as wear and damage.
- The recommended cold tire pressure for your vehicle can be found in this manual and on the tire label located on the driver's side center pillar. Always use a tire pressure gauge to measure tire pressure. Tires with too much or too little pressure wear unevenly causing poor handling.
- Check the pressure of the spare every time you check the pressure of the other tires on your vehicle.
- Replace tires that are worn, show uneven wear, or are damaged. Worn tires can cause loss of braking effectiveness, steering control, or traction.
- ALWAYS replace tires with the same size, type, construction and tread pattern as each tire that was originally supplied with this vehicle. Using tires and wheels other than the recommended sizes could cause unusual handling characteristics, poor vehicle control, or negatively affect your vehicle's Anti-Lock Brake System (ABS) resulting in a serious accident.

Tire care

For proper maintenance, safety, and maximum electric energy economy, you must always maintain recommended tire inflation pressures and stay within the load limits and weight distribution recommended for your vehicle.



All specifications (sizes and pressures) can be found on a label attached to the driver's side center pillar.

Recommended cold tire inflation pressures

All tire pressures (including the spare) should be checked when the tires are cold. "Cold tires" means the vehicle has not been driven for at least 3 hours or driven less than 1.6 km (1 mi.).

Warm tires normally exceed recommended cold tire pressures by 28 to 41 kPa (4 to 6 psi). Do not release air from warm tires to adjust the pressure or the tires will be under-inflated. For recommended inflation pressure, refer to the "Tires and wheels" section in chapter 2.



WARNING

Recommended pressures must be maintained for the best ride, vehicle handling, and minimum tire wear.

Over-inflation or under-inflation can reduce tire life, adversely affect vehicle handling, and lead to sudden tire failure that could result in loss of vehicle control resulting in an accident.

Severe under-inflation can lead to severe heat build-up, causing blowouts, tread separation and other tire failures that can result in the loss of vehicle control resulting in an accident. This risk is much higher on hot days and when driving for long periods at high speeds.



CAUTION

- Under-inflation results in excessive wear, poor handling and reduced electric energy economy. Wheel deformation is also possible. Keep your tire pressures at the proper levels. If a tire frequently needs refilling, we recommend it be checked by an authorized HYUNDAI dealer.
 - Over-inflation produces a harsh ride, excessive wear at the center of the tire tread, and a greater possibility of damage from road hazards.
-

Check tire inflation pressure

Check your tires, including the spare tire, once a month or more.

How to check

Use a good quality tire pressure gauge to check tire pressure. You can not tell if your tires are properly inflated simply by looking at them. Radial tires may look properly inflated when they are under-inflated.

Remove the valve cap from the tire valve stem. Press the tire gauge firmly onto the valve to get a pressure measurement. If the cold tire inflation pressure matches the recommended pressure on the tire and loading information label, no further adjustment is necessary. If the pressure is low, add air until you reach the recommended pressure. Make sure to put the valve caps back on the valve stems. Without the valve cap, dirt or moisture could get into the valve core and cause air leakage. If a valve cap is missing, install a new one as soon as possible.

If you overfill the tire, release air by pushing on the metal stem in the center of the tire valve. Recheck the tire pressure with the tire gauge. Be sure to put the valve caps back on the valve stems. Without the valve cap, dirt or moisture could get into the valve core and cause air leakage. If a valve cap is missing, install a new one as soon as possible.

Tire rotation

To equalize tread wear, HYUNDAI recommends that the tires be rotated every 12,000 km (7,500 mi.) or sooner if irregular wear develops.

During rotation, check the tires for correct balance.

When rotating tires, check for uneven wear and damage. Abnormal wear is usually caused by incorrect tire pressure, improper wheel alignment, out-of-balance wheels, severe braking or severe cornering. Look for bumps or bulges in the tread or side of the tire. Replace the tire if you find any of these conditions. Replace the tire if fabric or cord is visible. After rotation, be sure to bring the front and rear tire pressures to specification and check wheel lug nut tightness (proper torque is 11-13 kgf-m (79-94 lbf-ft)).

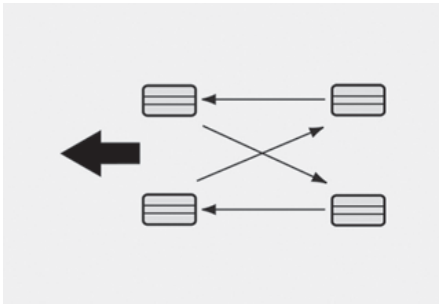

Disc brake pads should be inspected for wear whenever tires are rotated.

i Information

The outside and inside of the unsymmetrical tire is distinguishable. When installing an unsymmetrical tire, be sure to install the side marked "outside" face the outside. If the side marked "inside" is installed on the outside, it will have a negative effect on vehicle performance.

WARNING

- Do not use the compact spare tire for tire rotation.
- Do not mix bias ply and radial ply tires under any circumstances. This may cause unusual handling characteristics that may cause loss of vehicle control resulting in an accident.

Wheel alignment and tire balance

The wheels on your vehicle were aligned and balanced carefully at the factory to give you the longest tire life and best overall performance.

In most cases, you will not need to have your wheels aligned again. However, if you notice unusual tire wear or your vehicle pulling one way or the other, the alignment may need to be reset.

If you notice your vehicle vibrating when driving on a smooth road, your wheels may need to be rebalanced.

NOTICE

Incorrect wheel weights can damage your vehicle's aluminum wheels. Use only approved wheel weights.

Tire replacement



[A] Tread wear indicator

If the tire is worn evenly, a tread wear indicator will appear as a solid band across the tread. This shows there is less than 1.6 mm (1/16 in.) of tread left on the tire. Replace the tire when this happens.

Do not wait for the band to appear across the entire tread before replacing the tire.

WARNING

To reduce the risk of DEATH or SERIOUS INJURY:

- Replace tires that are worn, show uneven wear, or are damaged. Worn tires can cause loss of braking effectiveness, steering control, and traction.
- Always replace tires with the same size as each tire that was originally supplied with this vehicle. Using tires and wheels other than the recommended sizes could cause unusual handling characteristics, poor vehicle control, or negatively affect your vehicle's Anti-Lock Brake System (ABS) resulting in a serious accident.

- When replacing tires (or wheels), it is recommended to replace the two front or two rear tires (or wheels) as a pair. Replacing just one tire can seriously affect your vehicle's handling.
- Tires degrade over time, even when they are not being used. Regardless of the remaining tread, HYUNDAI recommends that tires be replaced after 6 years of normal service.
- Heat caused by hot climates or frequent high loading conditions can accelerate the aging process. Failure to follow this warning may cause sudden tire failure, which could lead to a loss of vehicle control resulting in an accident.

WARNING

The original tire should be repaired or replaced as soon as possible to avoid failure of the spare and loss of vehicle control resulting in an accident. The compact spare tire is for emergency use only. Do not operate your vehicle over 80 km/h (50 mph) when using the compact spare tire.

Wheel replacement

When replacing the metal wheels for any reason, make sure the new wheels are equivalent to the original factory units in diameter, rim width and offset.

Tire traction

Tire traction can be reduced if you drive on worn tires, tires that are improperly inflated or on slippery road surfaces. Tires should be replaced when tread wear indicators appear. To reduce the possibility of losing control, slow down whenever there is rain, snow or ice on the road.

Tire maintenance

In addition to proper inflation, correct wheel alignment helps to decrease tire wear. If you find a tire is worn unevenly, have your dealer check the wheel alignment.

When you have new tires installed, make sure they are balanced. This will increase vehicle ride comfort and tire life. Additionally, a tire should always be rebalanced if it is removed from the wheel.

Tire sidewall labeling

This information identifies and describes the fundamental characteristics of the tire and also provides the tire identification number (TIN) for safety standard certification. The TIN can be used to identify the tire in case of a recall.

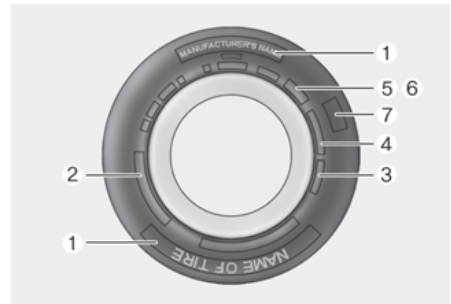

1. **Manufacturer or brand name**

Manufacturer or brand name is shown.

2. **Tire size designation**

A tire's sidewall is marked with a tire size designation. You will need this information when selecting replacement tires for your car. The following explains what the letters and numbers in the tire size designation mean.

Example tire size designation:

(These numbers are provided as an example only; your tire size designator could vary depending on your vehicle.)

245/40R20 99W

245 - Tire width in millimeters.
 40 - Aspect ratio. The tire's section height as a percentage of its width.
 R - Tire construction code (Radial).
 20 - Rim diameter in inches.
 99 - Load Index, a numerical code associated with the maximum load the tire can carry.
 W - Speed Rating Symbol. See the speed rating chart in this section for additional information.

Wheel size designation

Wheels are also marked with important information that you need if you ever have to replace one. The following explains what the letters and numbers in the wheel size designation mean.

Example wheel size designation:

8.5 X 20

8.5 - Rim width in inches.
 J - Rim contour designation.
 20 - Rim diameter in inches.

Tire speed ratings

The chart below lists many of the different speed ratings currently being used for passenger vehicle tires. The speed rating is part of the tire size designation on the sidewall of the tire. This symbol corresponds to that tire's designed maximum safe operating speed.

Speed Rating Symbol	Maximum Speed
S	180 km/h (112 mph)
T	190 km/h (118 mph)
H	210 km/h (130 mph)
V	240 km/h (149 mph)
W	270 km/h (168 mph)
Y	300 km/h (186 mph)

3. Checking tire life (TIN: Tire Identification Number)

Any tires that are over six years old, based on the manufacturing date, (including the spare tire) should be replaced by new ones. You can find the manufacturing date on the tire sidewall (possibly on the inside of the wheel), displaying the DOT Code. The DOT Code is a series of numbers on a tire consisting of numbers and English letters. The manufacturing date is designated by the last four digits (characters) of the DOT code.

DOT: XXXX XXXX OOOO

The front part of the DOT shows a plant code number, tire size and tread pattern and the last four numbers indicate week and year manufactured.

For example:

DOT XXXX XXXX 5024 represents that the tire was produced in the 50th week of 2024.

4. Tire ply composition and material

The number of layers or plies of rubber-coated fabric in the tire. Tire manufacturers also must indicate the materials in the tire, which include steel, nylon, polyester, and others. The letter "R" means radial ply construction; the letter "D" means diagonal or bias ply construction; and the letter "B" means belted-bias ply construction.

5. Maximum permissible inflation pressure

This number is the greatest amount of air pressure that should be put in the tire. Do not exceed the maximum permissible inflation pressure.

6. Maximum load rating

This number indicates the maximum load in kilograms and pounds that can be carried by the tire. When replacing the tires on the vehicle, always use a tire that has the same load rating as the factory installed tire.

7. Uniform tire quality grading

Quality grades can be found where applicable on the tire sidewall between tread shoulder and maximum section width.

For example:

TREADWEAR 200

TRACTION AA

TEMPERATURE A

Tread wear

The tread wear grade is a comparative rating based on the wear rate of the tire when tested under controlled conditions on a specified government test course. For example, a tire graded 150 would wear one-and-a-half times ($1\frac{1}{2}$) as well on the government course as a tire graded 100.

The relative performance of tires depends upon the actual conditions of their use, however, and may depart significantly from the norm due to variations in driving habits, service practices and differences in road characteristics and climate.

These grades are molded on the sidewalls of passenger vehicle tires. The tires available as standard or optional equipment on your vehicle may vary with respect to grade.

Traction - AA, A, B & C

The traction grades, from highest to lowest, are AA, A, B and C. Those grades represent the tire's ability to stop on wet pavement as measured under controlled conditions on specified government test surfaces of asphalt and concrete. A tire marked C may have poor traction performance.

WARNING

The traction grade assigned to this tire is based on straight ahead braking traction tests, and does not include acceleration, cornering, hydroplaning, or peak traction characteristics.

Temperature - A, B & C

The temperature grades are A (the highest), B and C representing the tire's resistance to the generation of heat and its ability to dissipate heat when tested under controlled conditions on a specified indoor laboratory test wheel. Sustained high temperature can cause the material of the tire to degenerate and reduce tire life, and excessive temperature can lead to sudden tire failure. Grades B and A represent higher levels of performance on the laboratory test wheel than the minimum required by law.

WARNING

The temperature grade for this tire is established for a tire that is properly inflated and not overloaded. Excessive speed, under-inflation, over-inflation, or excessive loading, either separately or in combination, can cause heat build-up and possible sudden tire failure. This may cause loss of vehicle control resulting in an accident.

Low aspect ratio tires

 If equipped

The aspect ratio is lower than 50 on low aspect ratio tires.

Because low aspect ratio tires are optimized for handling and braking, their sidewall is a little stiffer than a standard tire. Also low aspect ratio tires tend to be wider and consequently have a greater contact patch with the road surface. In some instances they may generate more road noise compared with standard tires.

⚠ CAUTION

The side wall of a low aspect ratio tire is shorter than the normal one. Thus, the low-aspect wheel and tire are easily damaged. Follow the below instructions.

- When driving on a rough road or driving off a road, be careful not to damage the tires and wheels. After driving, inspect the tires and wheels.
- When passing over a pothole, speed bump, manhole, or curb stone, drive the vehicle slowly so as not to damage the tires and wheels.
- When there is an impact on a tire, inspect the tire condition. We recommend that you contact an authorized HYUNDAI dealer.
- Inspect the tire condition and pressure every 3,000 km (1,800 mi.) to prevent tire damage.
- It is difficult to recognize a tire damage only with your eyes. When there is a slight hint of a tire damage, check and replace the tire to prevent the damage caused by air leakage.
- When a tire is damaged while driving on a rough road, off a road, or over obstacles, such as a pothole, manhole, or curb stone, your warranty does not cover the damage.
- The tire information is specified on the tire side wall.

Fuses

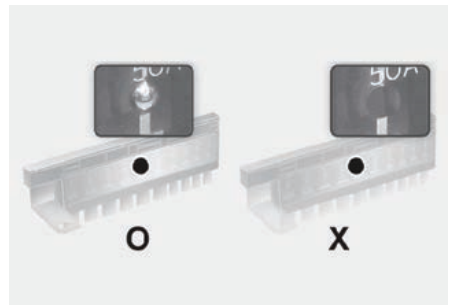
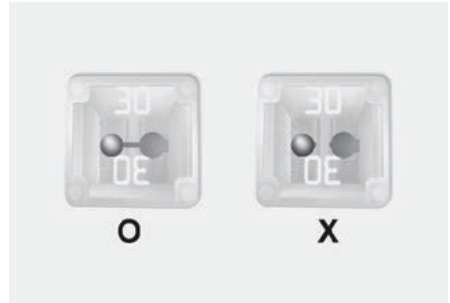

A vehicle's electrical system is protected from electrical overload damage by fuses.

This vehicle has 2 (or 3) fuse panels, one located in the driver's side panel bolster, the other in the vehicle compartment.

If any of your vehicle's lights, accessories, or controls do not work, check the appropriate circuit fuse. If a fuse has blown, the element inside the fuse will be melted or broken.

If the electrical system does not work, first check the driver's side fuse panel. Before replacing a blown fuse, turn the vehicle and all switches off, and then disconnect the negative battery cable. Always replace a blown fuse with one of the same rating.

If the replacement fuse blows, this indicates an electrical problem. Avoid using the system involved. We recommend that you immediately consult an authorized HYUNDAI dealer.

WARNING

NEVER replace a fuse with anything but another fuse of the same rating.

- A higher capacity fuse could cause damage and possibly cause a fire.
- Do not install a wire or aluminum foil instead of the proper fuse - even as a temporary repair. It may cause extensive wiring damage and possibly a fire.

NOTICE

Do not use a screwdriver or any other metal object to remove fuses because it may cause a short circuit and damage the system.

Instrument panel fuse replacement

Driver's side



1. Turn the vehicle off.
2. Turn all other switches off.
3. Open the fuse panel cover.
4. Refer to the label on the inside of the fuse panel cover to locate the suspected fuse location.

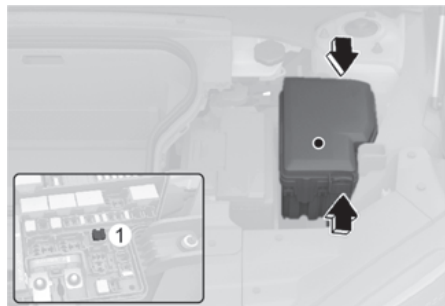

5. Pull the suspected fuse straight out. Use the removal tool (1) provided in the motor compartment fuses panel.
6. Check the removed fuse; replace it if it is blown. Spare fuses are provided in the instrument panel fuse panels (or in the motor compartment fuse panel).

7. Push in a new fuse of the same rating, and make sure it fits tightly in the clips. If it fits loosely, we recommend that you consult an authorized HYUNDAI dealer.

In an emergency, if you do not have a spare fuse, use a fuse of the same rating from a circuit you may not need for operating the vehicle, such as the cigarette lighter fuse.

If the headlights or other electrical components do not work and the fuses are undamaged, check the fuse panel in the motor compartment. If a fuse is blown, it must be replaced with the same rating.

Motor compartment panel fuse replacement

Blade fuse / Cartridge fuse

Blade type fuse

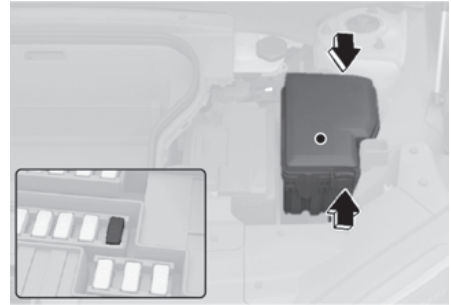

Cartridge type fuse

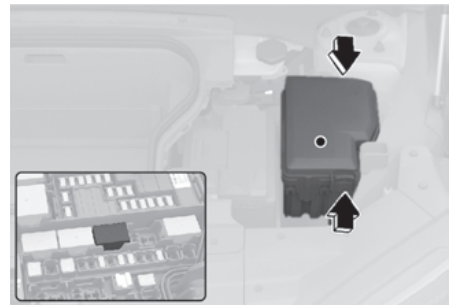

1. Turn the vehicle off.
2. Turn all other switches off.
3. Remove the fuse panel cover by pressing the tap and pulling up.
4. Check the removed fuse; replace it if it is blown. To remove or insert the fuse, use the removal tool in the motor compartment fuse panel.

5. Push in a new fuse of the same rating, and make sure it fits tightly in the clips. If it fits loosely, we recommend that you consult an authorized HYUNDAI dealer.

NOTICE

After checking the fuse panel in the motor compartment, securely install the fuse panel cover. You may hear a clicking sound if the cover is securely latched. If it is not securely latched, electrical failure may occur from water contact.





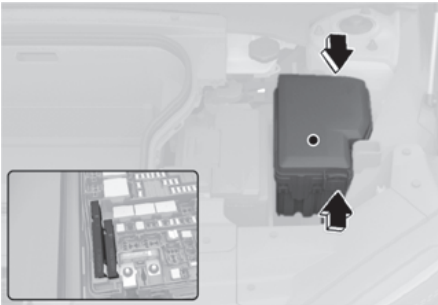







Multi fuse

Multi type

















If the multi fuse is blown, we recommend that you consult an authorized HYUNDAI dealer.

Instrument panel fuse panel















Fuse Name	Symbol	Fuse Rating	Circuit Protected
AFCU		10 A	Driver/Passenger Door Outside Handle
EPCU3		10 A	Rear Inverter
START		7.5 A	IBU, VCU
IG3 8		10 A	In-car Temperature Sensor, A/C Control Module, A/C PTC Heater, Instrument Cluster, CCU, AVNT Head Unit
MEMORY 2		10 A	Instrument Cluster, ADAS Unit (Parking)
MULTIMEDIA		15 A	AVNT Head Unit
AIRBAG2		10 A	SRS Control Module
P/SEAT PASS		30 A	Passenger Power Seat Switch, Passenger Seat Unit
CLUSTER		7.5 A	Instrument Cluster, Head-Up Display
MODULE5		10 A	Data Link Connector, Electro Chromic Mirror, A/V & Navigation Head Unit, Intelligent Front Lighting System, Head light LH/RH, AMP, Acoustic Design Processor, SmartPhone Wireless Charger, Driver/Passenger Power Seat Module, Front Air Ventilation Seat Control Module, Front Seat Warmer Control Module, Rear Power Seat LH/RH Module, Rear Seat Warmer Control Module
IG3 11		10 A	Electronic A/C Compressor
IG3 9		10 A	Rear Inverter, BMU
CCU		10 A	CCU



Fuse Name	Symbol	Fuse Rating	Circuit Protected
MODULE1	1 MODULE	10 A	Hazard light Switch, Multifunction Switch, Data Link Connector, Rain Sensor, P/R Junction Block (Blower Relay), Center Power Window Switch, Outside Mirror Switch, A/C Control Module, Crash Pad Mood Lamp, Driver/Passenger/Rear LH/RH Door Mood Lamp, UIP Siren, PTL Unit

Instrument panel fuse panel

Fuse Name	Symbol	Fuse Rating	Circuit Protected
SBCM DRV		20 A	Driver Side Body Control Module
S/HEATER FRT		25 A	Front Air Ventilation Seat Control Module, Front Seat Warmer Control Module
MODULE4		10 A	Front/Rear Corner Radar LH/RH, Rear Inverter (System), Front View Camera, IBU, ADAS Unit (Parking/Driving), Crash Pad Switch, VESS Unit, DSM Monitor (Driver/Passenger), Smart Cruise Control Radar
AIRBAG1		15 A	SRS Control Module
MODULE2		10 A	AMP, Acoustic Design Processor, P/E Junction Block (Power Outlet Relay), IBU, ADAS Parking ECU, A/V & Navigation Keyboard, A/V & Navigation Head Unit, Data Connectivity Unit, Central Communication Unit
WASHER		15 A	Multifunction Switch
MODULE6		7.5 A	IBU
IG3 10		10 A	SCU, Rear Electronic Oil Pump, VCMS, V2L Unit, ICCU
MEMORY1		10 A	Acoustic Design Processor, Head Up Display, Data Connectivity Unit, A/C Control Module, Mood Lamp Unit
IBU1		15 A	IBU
AMP		30 A	AMP
S/HEATER RR		20 A	Rear Seat Warmer Control Module
A/BAG IND		7.5 A	Overhead Console Assembly
E-SHIFTER3		10 A	Electronic Shift Switch

Instrument panel fuse panel

Fuse Name	Symbol	Fuse Rating	Circuit Protected
USB CHARGER RR		25 A	Rear USB Charger #1,#2,#3,#4
MODULE7		7.5 A	Not Used
A/CON		7.5 A	A/C Control Module
MODULE8		15 A	Driver IMS Module, Passenger Seat Unit
DOOR LOCK		20 A	Door Lock/Unlock Relay, Dead Lock Relay
SBCM PASS		20 A	Passenger Side Body Control Module
P/WINDOW LH		25 A	Rear Power Window Switch LH, Rear Safety Power Window Module LH, Driver Power Window Module, Driver/Passenger Safety Power Window Module
MODULE3		7.5 A	Stop light Switch, Center Power Window Switch, Multifunction Switch
MODULE9		10 A	Central Communication Unit, Data Connectivity Unit
WIDE SUNROOF		25 A	Wide Sunroof
CHARGER		10 A	VCMS, ICCU, Charger Connector Lock/Unlock Relay
POWER TRUNK		30 A	PTL Unit
P/WINDOW RH		25 A	Rear Power Window Switch LH, Rear Safety Power Window Module LH, Driver Power Window Module, Driver/Passenger Safety Power Window Module
IBU2		7.5 A	IBU

Fuse Name	Symbol	Fuse Rating	Circuit Protected
BMS	BATTERY MANAGEMENT	10 A	BMU
BRAKE SWITCH	BRAKE SWITCH	10 A	Stop light Switch, IBU
TRUNK		15 A	Trunk Release Relay
P/SEAT DRV	DRV 	30 A	Driver Power Seat Switch, Driver IMS Module

Motor compartment fuse panel

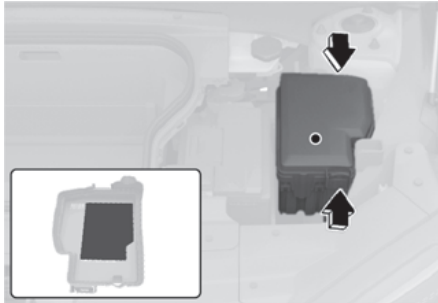









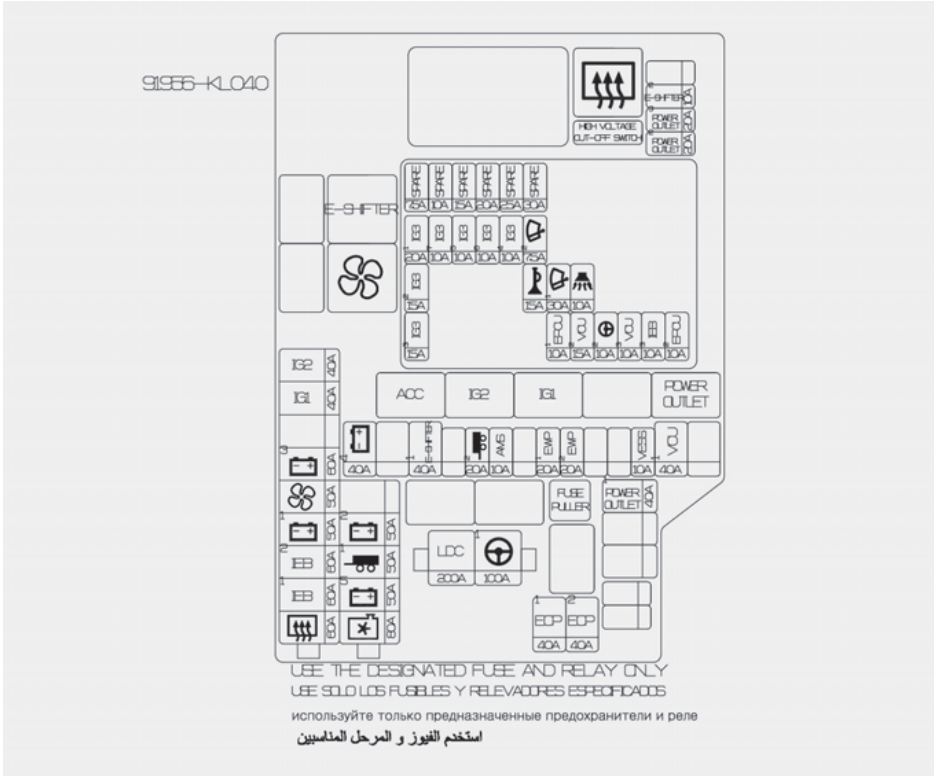





Inside the fuse/relay box cover, you can find the fuse/relay label describing fuse/relay names and ratings.

***i* Information**

Not all fuse panel descriptions in this manual may be applicable to your vehicle; the information is accurate at the time of printing. When you inspect the fuse panel in your vehicle, refer to the fuse panel label.











Motor compartment fuse panel





Type	Fuse Name	Symbol	Fuse Rating	Circuit Protected
MULTI FUSE-1	LDC		200 A	ICCU (LDC), P/R Junction Block (Fuse: POWER OUTLET1, EOP1, EOP2, LDC2)
	MDPS1*		100 A	MDPS Unit
MULTI FUSE-2	RR HTD		60 A	P/R Junction Block (RLY. 10)
	IEB1		60 A	IEB Unit
	IEB2		50 A	IEB Unit
	B+1		50 A	ICU Junction Block (Fuse: IPS1, IPS2, IPS3, IPS4, IPS6)P/R Junction Block (RLY.5, RLY.7)
	BLOWER		50 A	P/R Junction Block (RLY. 9)
	B+3		60 A	ICU Junction Block (FUSE: F1,F2,F13,F24,F34, F44,F50,F54)
	IG1		40 A	P/R Junction Block (RLY. 1, RLY. 3)
	IG2		40 A	P/R Junction Block (RLY. 2)
MULTI FUSE-3	COOLING FAN		80 A	Cooling Fan Motor
	B+5		50 A	PCB Block (Main Relay, Fuse: VCU2, EPCU1, WIPER1, B/A HORN, HORN)
	TRAILER		50 A	Trailer Connector
	B+2		50 A	ICU Junction Block (Fuse: IPS5, IPS7, IPS8, IPS9)

*1 MDPS(Motor Driven Power Steering) is the same as EPS(Electric Power Steering)

Motor compartment fuse panel

Type	Fuse Name	Symbol	Fuse Rating	Circuit Protected
FUSE	B+4		40 A	ICU Junction Block (Long Term Load Latch Relay, Fuse: F10,F11,F21,F22,F32,F33,F41,F42,F47,F48,F52,F53,F56)
	E-SHIFTER1		40 A	P/R Junction Block (RLY. 8, Fuse: F13)
	TRAILER2		20 A	Trailer Connector
	AMS		10 A	12V Battery
	EWP1		20 A	Electronic Water Pump #1 (HV Battery)
	EWP2		20 A	Electronic Water Pump #2 (HV Battery)
	VESS		10 A	VESS Unit
	VCU1		40 A	VCU(AWD)
	POWER OUTLET1		40 A	P/R Junction Block (RLY. 5)
	EOP1		40 A	Rear Electronic Oil Pump

Type	Fuse Name	Symbol	Fuse Rating	Circuit Protected
FUSE	EOP2	² EOP	40 A	Front Electronic Oil Pump
	E-SHIFTER2	² E-SHIFTER	10 A	SCU, Electronic Shift Switch, P/R Junction Block (RLY. 8)
	POWER OUTLET3	³ POWER OUTLET	20 A	Rear Power Outlet
	POWER OUTLET2	² POWER OUTLET	20 A	Front Power Outlet
	WIPER1	¹ 	30 A	PCB Block (Wiper Main Relay)
	EPCU1	¹ EPCU	10 A	Front Inverter (AWD)
	B/ALARM		10 A	PCB Block (Burglar Alarm Horn Relay)
	HORN		15 A	PCB Block (Horn Relay)

Motor compartment fuse panel

Fuse Name	Symbol	Fuse Rating	Circuit Protected
WIPER2	² 	7.5 A	IBU
VCU2	² 	15 A	VCU
IG3 1	¹ 	20 A	ICU Junction Block (Fuse: F7,F18,F19,F30)
IG3 3	³ 	15 A	Electronic Water Pump
IG3 5	⁵ 	10 A	A/C Coolant Valve, Electronic Water Pump Batt #1, #2
VCU3	³ 	10 A	VCU
IG3 4	⁴ 	10 A	VCU
IEB3	³ 	10 A	IEB Unit
IG3 6	⁶ 	10 A	BMS Coolant 3Way Valve
MDPS2 ^{*1}	² 	10 A	MDPS Unit
IG3 2	² 	15 A	Front Inverter (AWD)
IG3 7	⁷ 	10 A	Cooling Fan Motor, Front Electronic Oil Pump (AWD)
EPCU2	² 	10 A	Front Inverter (AWD)

*1 MDPS(Motor Driven Power Steering) is the same as EPS(Electric Power Steering)

Light bulbs

We recommend you to consult an authorized HYUNDAI dealer to replace most vehicle light bulbs. It is difficult to replace vehicle light bulbs because other parts of the vehicle must be removed before you can get to the bulb. This is especially true for removing the headlight assembly to get to the bulb(s).

Removing/installing the headlight assembly can result in damage to the vehicle.

WARNING

- Prior to working on a light, depress the foot brake, shift to P (Park), apply the parking brake, press the Start/Stop button to the OFF position and take the key with you when leaving the vehicle to avoid sudden movement of the vehicle and to prevent possible electric shock.
- Be aware the bulbs may be hot and may burn your fingers.

NOTICE

Be sure to replace the burned-out bulb with one of the same wattage rating. Otherwise, it may cause damage to the fuse or electrical wiring system.

NOTICE

To prevent damage, do not clean the headlight lens with chemical solvents or strong detergents.

i Information

This vehicle is equipped with desiccant to reduce fogging inside the headlight due to moisture. The desiccant is consumable and its performance may change based on the used period or environment. If fogging inside the headlight due to moisture continues for a long time, we recommend that you consult an authorized HYUNDAI dealer.

i Information

The headlight and tail light lenses could appear frosty if the vehicle is washed after driving or the vehicle is driven at night in wet weather. This condition is caused by temperature difference between the lamp inside and outside and, it does not indicate a problem with your vehicle. When moisture condenses in the lamp, it will be removed after driving with the headlight on. The removable level may differ depending on lamp size, lamp position and environmental condition. However, if moisture is not removed, we recommend that your vehicle be inspected by an authorized HYUNDAI dealer.

i Information

- A normally functioning lamp may flicker momentarily to stabilize the vehicle's electrical control system. However, if the light goes out after flickering momentarily, or continues to flicker, we recommend the system be checked by an authorized HYUNDAI dealer.
- The position light may not turn on when the position light switch is turned on, but the position light and headlight switch may turn on when the headlight switch is turned on. This may be caused by network failure or vehicle electrical control system malfunction. If this occurs, we recommend the system be checked by an authorized HYUNDAI dealer.

i Information

The headlight aiming should be adjusted after an accident or after the headlight assembly is reinstalled.

i Information

Traffic Change (For Europe)

The low beam light distribution is asymmetric. If you go abroad to a country with opposite traffic direction, this asymmetric part will dazzle oncoming car driver. To prevent dazzle, ECE regulation demand several technical solutions (for example, automatic change system, adhesive sheet, down aiming). This headlights are designed not to dazzle opposite drivers. So, you need not change your headlights in a country with opposite traffic direction.

Headlight, position light, turn signal light, Daytime Running Light (DRL) replacement

Type A

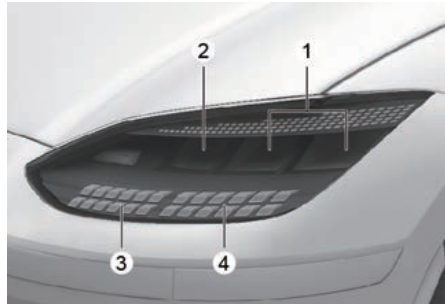

Type B

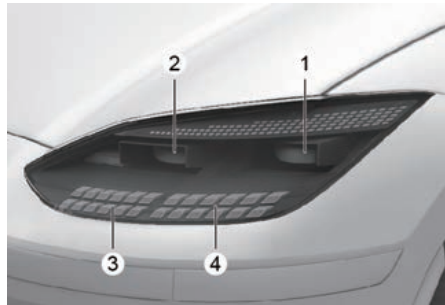

- (1) Headlight (High)
- (2) Headlight (Low)
- (3) Position light/Daytime running light
- (4) Turn signal light

If the LED light does not operate, we recommend that the system be inspected by an authorized HYUNDAI dealer.

The LED lights cannot be replaced as a single unit because it is an integrated unit. The LED lights has to be replaced with the unit.

A skilled technician should check or repair the LED light, for it may damage related parts of the vehicle.

Side repeater light replacement

Type A



Type B

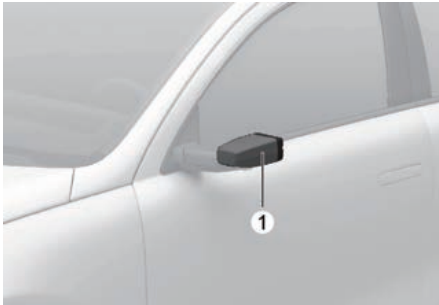

If the LED light (1) does not operate, we recommend that the system be inspected by an authorized HYUNDAI dealer.

The LED lights cannot be replaced as a single unit because it is an integrated unit. The LED lights has to be replaced with the unit.

A skilled technician should check or repair the LED light, for it may damage related parts of the vehicle.

Headlight aiming (For Europe)

Type A

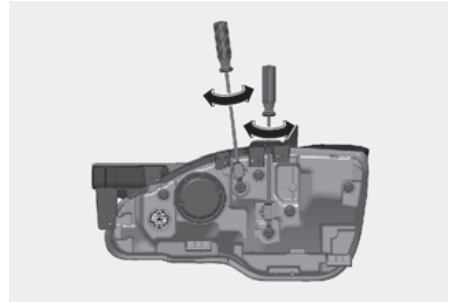

Type B

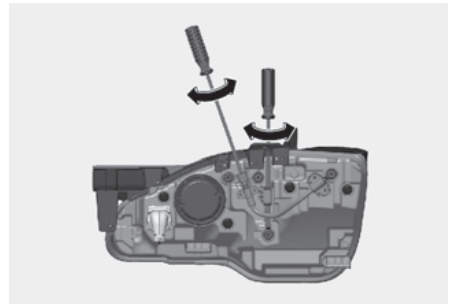

1. Inflate the tires to the specified pressure and remove any loads from the vehicle except the driver, spare tire, and tools.
2. The vehicle should be placed on a flat floor.
3. Draw vertical lines (Vertical lines passing through respective head light centers) and a horizontal line (Horizontal line passing through center of head lights) on the screen.
4. With the headlight and battery in normal condition, aim the headlights so the brightest portion falls on the horizontal and vertical lines.
5. To aim the low beam and high beam left or right, turn the driver clockwise or counterclockwise.

To aim the low beam and high beam up or down, turn the driver clockwise or counterclockwise.

Aiming point

Type A

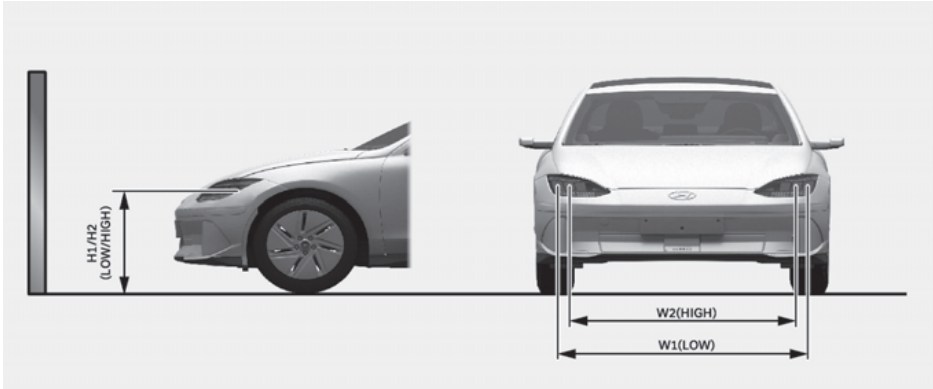

Type B

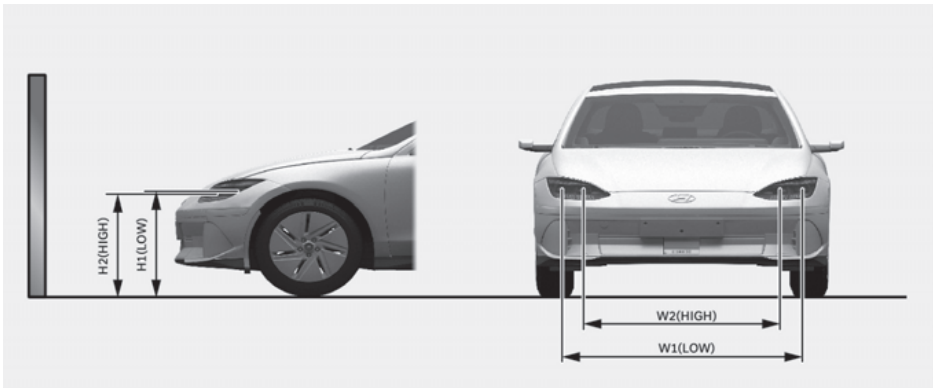

- H1: Height between the head light bulb center and ground (Low beam)
- H2: Height between the head light bulb center and ground (High beam)
- W1: Distance between the two head light bulbs centers (Low beam)
- W2: Distance between the two head light bulbs centers (High beam)

VEHICLE CONDITION	LAMP TYPE	H1	H2	W1	W2
WITHOUT DRIVER	Type A	725 mm (28.5 in.)	725 mm (28.5 in.)	1520 mm (59.8 in.)	1446 mm (56.9 in.)
	Type B	722 mm (28.4 in.)	713 mm (28.0 in.)	1516 mm (59.7 in.)	1256 mm (49.4 in.)
WITH DRIVER	Type A	715 mm (28.1 in.)	715 mm (28.1 in.)	1520 mm (59.8 in.)	1446 mm (56.9 in.)
	Type B	712 mm (28.0 in.)	703 mm (27.6 in.)	1516 mm (59.7 in.)	1256 mm (49.4 in.)

Headlight low beam

Based on 10m screen (Left-hand drive)

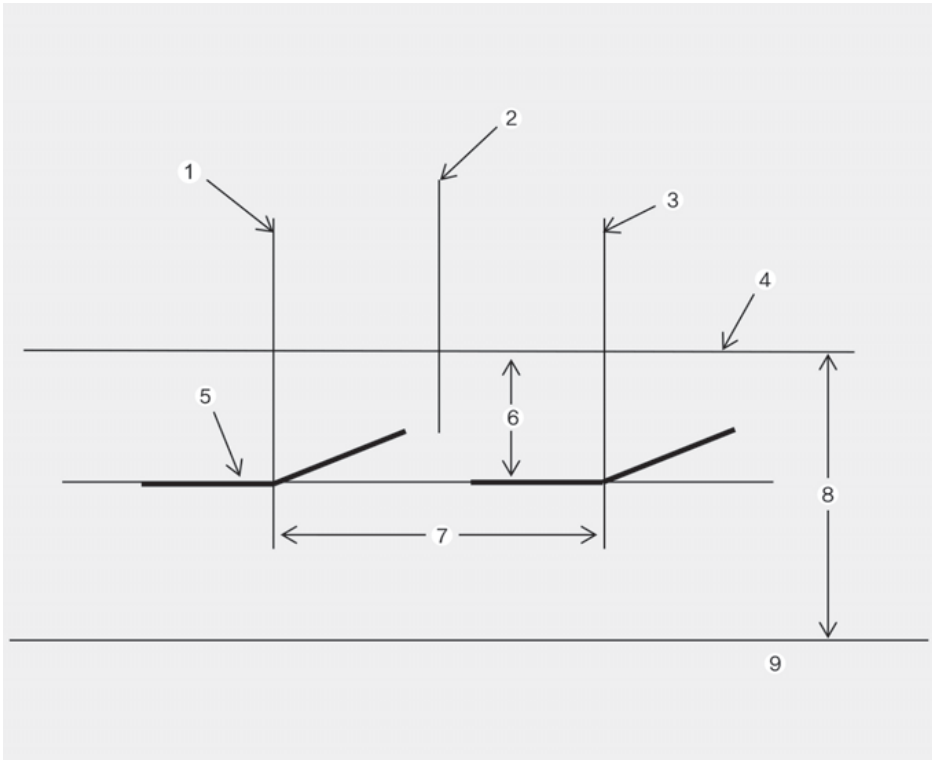

- (1) Vertical line of the left headlight bulb center
- (2) Car axis
- (3) Vertical line of the right headlight bulb center
- (4) Horizontal line of headlight bulb center
- (5) Cut-off line
- (6) 100
- (7) W1 (Low beam)
- (8) H1 (Low beam)
- (9) Ground

1. Turn the low beam on without driver aboard.
2. The cut-off line should be projected in the cut-off line shown in the picture.
3. When aiming the low beam, vertical aiming should be adjusted after adjusting the horizontal aiming.
4. If headlight leveling device is equipped, adjust the headlight leveling device switch to "0".

***i* Information**

The high beam is aimed simultaneously when aiming the low beam.

Based on 10m screen (Right-hand drive)

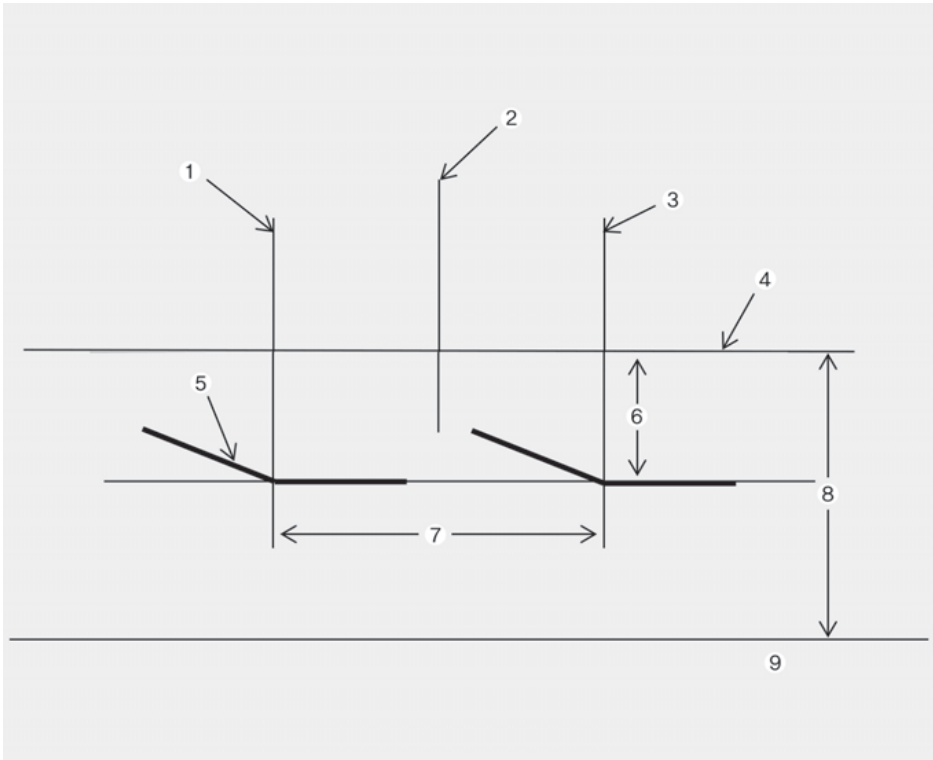

- (1) Vertical line of the left headlight bulb center
- (2) Car axis
- (3) Vertical line of the right headlight bulb center
- (4) Horizontal line of headlight bulb center
- (5) Cut-off line
- (6) 100
- (7) W1 (Low beam)
- (8) H1 (Low beam)
- (9) Ground

1. Turn the low beam on without driver aboard.
2. The cut-off line should be projected in the cut-off line shown in the picture.
3. When aiming the low beam, vertical aiming should be adjusted after adjusting the horizontal aiming.
4. If headlight leveling device is equipped, adjust the headlight leveling device switch to "0".

***i* Information**

The high beam is aimed simultaneously when aiming the low beam.

Rear combination light replacement

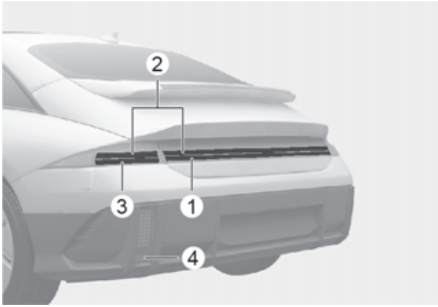

- (1) Stop light
- (2) Rear light/Stop light
- (3) Turn signal light
- (4) Backup light/Rear fog light

If the LED light does not operate, we recommend that the system be inspected by an authorized HYUNDAI dealer.

The LED lights cannot be replaced as a single unit because it is an integrated unit. The LED lights has to be replaced with the unit.

A skilled technician should check or repair the LED light, for it may damage related parts of the vehicle.

High mounted stop light replacement

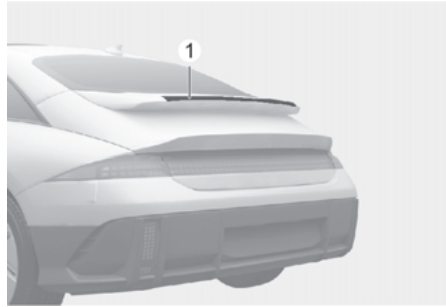

If the LED light (1) does not operate, we recommend that the system be inspected by an authorized HYUNDAI dealer.

The LED lights cannot be replaced as a single unit because it is an integrated unit. The LED lights has to be replaced with the unit.

A skilled technician should check or repair the LED light, for it may damage related parts of the vehicle

License plate light replacement



If the LED light (1) does not operate, we recommend that the system be inspected by an authorized HYUNDAI dealer.

The LED lights cannot be replaced as a single unit because it is an integrated unit. The LED lights has to be replaced with the unit.

A skilled technician should check or repair the LED light, for it may damage related parts of the vehicle.

Front trunk light replacement



If the LED light (1) does not operate, we recommend that the system be inspected by an authorized HYUNDAI dealer.

The LED lights cannot be replaced as a single unit because it is an integrated unit. The LED lights has to be replaced with the unit.

A skilled technician should check or repair the LED light, for it may damage related parts of the vehicle.

Interior light replacement

First row lamp (if equipped)



Rear seat room lamp



Crash pad mood lamp (if equipped)



Glove box lamp

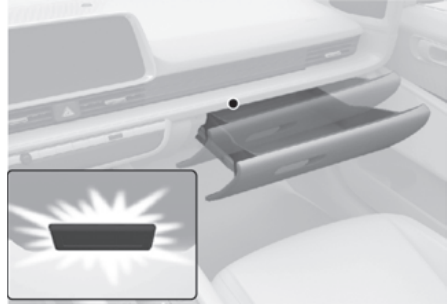

Door mood lamp (if equipped)

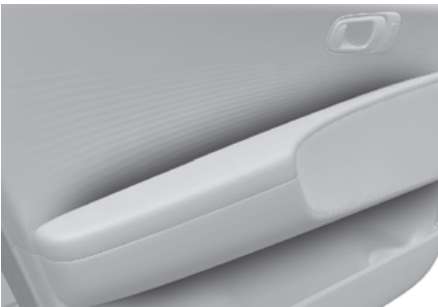

If the LED lamp (1) does not operate, we recommend that the system be inspected by an authorized HYUNDAI dealer.

The LED lamps cannot be replaced as a single unit because it is an integrated unit. The LED lamps has to be replaced with the unit.

A skilled technician should check or repair the LED lamp, for it may damage related parts of the vehicle.

Appearance care

Exterior care

NOTICE

If you park your vehicle near a stainless steel sign or glass facade building, the vehicle's exterior plastic parts such as a bumper, spoiler, garnish, lamp or outside rearview mirror might be damaged due to sunlight reflected from the sign or building. To prevent damage of the exterior plastic parts, you should avoid parking in areas where light may be reflected or use a car cover. (The exterior plastic parts applied to your vehicle may vary.)

Exterior general caution

It is very important to follow the label directions when using any chemical cleaner or polish. Read all warning and caution statements that appear on the label.

Finish maintenance

Washing

To help protect your vehicle's finish from rust and deterioration, wash it thoroughly and frequently at least once a month with lukewarm or cold water.

If you use your vehicle for off-road driving, you should wash it after each off-road trip. Pay special attention to the removal of any accumulation of salt, dirt, mud, and other foreign materials. Make sure the drain holes in the lower edges of the doors and rocker panels are kept clear and clean.

Insects, tar, tree sap, bird droppings, industrial pollution and similar deposits can damage your vehicle's finish if not removed immediately.

Even prompt washing with plain water may not completely remove all these deposits. A mild soap, safe for use on painted surfaces, should be used.

After washing, rinse the vehicle thoroughly with lukewarm or cold water. Do not allow soap to dry on the finish.

High-pressure washing

- When using high-pressure washers, make sure to maintain sufficient distance from the vehicle.

Insufficient clearance or excessive pressure can lead to component damage or water penetration.

- Do not spray the camera, sensors or its surrounding area directly with a high pressure washer. Shock applied from high pressure water may cause the device to not operate normally.
- Do not bring the nozzle tip close to boots (rubber or plastic covers) or connectors as they may be damaged if they come into contact with high pressure water.

⚠ WARNING

After washing the vehicle, test the brakes while driving slowly to see if they have been affected by water before getting on the road. If braking performance is impaired, dry the brakes by applying them lightly while maintaining a slow forward speed.

NOTICE

- Do not use strong soap, chemical detergents or hot water, and do not wash the vehicle in direct sunlight or when the body of the vehicle is warm.
- Be careful when washing the side windows of your vehicle.
- Especially, with high-pressure water, water may leak through the windows and wet the interior.
- To prevent damage to the plastic parts, do not clean with chemical solvents or strong detergents.

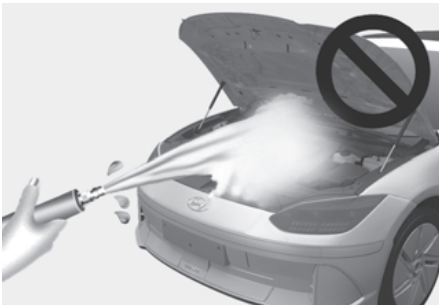

- Water washing in the motor compartment including high pressure water washing may cause the failure of electrical circuits located in the vehicle compartment.
 - Never allow water or other liquids to come in contact with electrical/electronic components inside the vehicle as water or other liquids may flow in to the motor compartment through the front trunk and damage electrical/electronic components.
-

NOTICE

Matte paint finish vehicle (if equipped) Automatic car wash which uses rotating brushes should not be used as this can damage the surface of your vehicle. A steam cleaner which washes the vehicle surface at high temperature may result the oil to adhere and leave stains that is difficult to remove.

Use a soft cloth (for example, microfiber towel or sponge) when washing your vehicle and dry with a microfiber towel. When you hand wash your vehicle, you should not use a cleaner that finishes with wax. If the vehicle surface is too dirty (sand, dirt, dust, contaminant, etc.), clean the surface with water before washing the car.

Waxing

A good coat of wax is a barrier between your paint and contaminate. Keeping a good coat of wax on your vehicle will help protect it.

Wax the vehicle when water will no longer bead on the paint.

Always wash and dry the vehicle before waxing. Use a good quality liquid or paste wax, and follow the manufacturer's instructions. Wax all metal trim to protect it and to maintain its luster.

Removing oil, tar, and similar materials with a spot remover will usually strip the wax from the finish. Be sure to re-wax these areas even if the rest of the vehicle does not yet need waxing.

NOTICE

- Wiping dust or dirt off the body with a dry cloth will scratch the finish.
- Do not use steel wool, abrasive cleaners, or strong detergents containing highly alkaline or caustic agents on chrome-plated or anodized aluminum parts. This may result in damage to the protective coating and cause discoloration or paint deterioration.

NOTICE

Matte paint finish vehicle (if equipped)
Do not use any polish protector such as a detergent, an abrasive and a polish. In case wax is applied, remove the wax immediately using a silicon remover and if any tar or tar contaminant is on the surface use a tar remover to clean. However, be careful not to apply too much pressure on the painted area.

Finish damage repair

Deep scratches or stone chips in the painted surface must be repaired promptly. Exposed metal will quickly rust and may develop into a major repair expense.

NOTICE

If your vehicle is damaged and requires any metal repair or replacement, be sure the body shop applies anti-corrosion materials to the parts repaired or replaced.

NOTICE

Matte paint finish vehicle (if equipped)
In case of matte paint finish vehicles, it is impossible to modify only the damaged area and repair of the whole part is necessary. If the vehicle is damaged and painting is required, we recommend that you have your vehicle maintained and repaired by an authorized HYUNDAI dealer. Take extreme care, as it is difficult to restore the quality after the repair.

Bright-metal maintenance

- To remove road tar and insects, use a tar remover, not a scraper or other sharp object.
- To protect the surfaces of bright metal parts from corrosion, apply a coating of wax or chrome preservative and rub to a high luster.
- During winter weather or in coastal areas, cover the bright metal parts with a heavier coating of wax or preservative. If necessary, coat the parts with non-corrosive petroleum jelly or other protective compound.

Underbody maintenance

Corrosive materials used for ice and snow removal and dust control may collect on the underbody. If these materials are not removed, accelerated rusting can occur on underbody parts such as the frame and floor pan, even though they have been treated with rust protection.

Thoroughly flush the vehicle underbody and wheel openings with lukewarm or cold water once a month, after off-road driving and at the end of each winter. Pay special attention to these areas because it is difficult to see all the mud and dirt. It will do more harm than good to wet down the road grime without removing it. The lower edges of doors, rocker panels, and frame members have drain holes that should not be allowed to clog with dirt; trapped water in these areas can cause rusting.

WARNING

After washing the vehicle, test the brakes while driving slowly to see if they have been affected by water. If braking performance is impaired, dry the brakes by applying them lightly while maintaining a slow forward speed.

Aluminum wheel maintenance

The aluminum wheels are coated with a clear protective finish.

- Do not use abrasive cleaner, polishing compound, solvent, or wire brushes on aluminum wheels.
- Clean the wheel when it has cooled.
- Use only a mild soap or neutral detergent, and rinse thoroughly with water. Also, clean the wheels after driving on salted roads.
- Do not wash the wheels with high-speed car wash brushes.
- Do not use any cleaners containing acid or alkaline detergents.

Corrosion protection

Protecting your vehicle from corrosion

By using the most advanced design and construction practices to combat corrosion, HYUNDAI produces vehicles of the highest quality. However, this is only part of the job. To achieve the long-term corrosion resistance your vehicle can deliver, the owner's cooperation and assistance is also required.

Common causes of corrosion

The most common causes of corrosion on your vehicle are:

- Road salt, dirt and moisture that is allowed to accumulate underneath the vehicle.
- Removal of paint or protective coatings by stones, gravel, abrasion or minor scrapes and dents which leave unprotected metal exposed to corrosion.

High-corrosion areas

If you live in an area where your vehicle is regularly exposed to corrosive materials, corrosion protection is particularly important. Some of the common causes of accelerated corrosion are road salts, dust control chemicals, ocean air and industrial pollution.

Moisture breeds corrosion

Moisture creates the conditions in which corrosion is most likely to occur. For example, corrosion is accelerated by high humidity, particularly when temperatures are just above freezing. In such conditions, the corrosive material is kept in contact with the vehicle surfaces by moisture that is slow to evaporate.

Mud is particularly corrosive because it is slow to dry and holds moisture in contact with the vehicle. Although the mud appears to be dry, it can still retain moisture and promote corrosion.

High temperatures can also accelerate corrosion of parts that are not properly ventilated so the moisture can be dispersed. For all these reasons, it is particularly important to keep your vehicle clean and free of mud or accumulations of other materials. This applies not only to the visible surfaces but particularly to the underside of the vehicle.

To help prevent corrosion

Keep your vehicle clean

The best way to prevent corrosion is to keep your vehicle clean and free of corrosive materials. Attention to the underside of the vehicle is particularly important.

- If you live in a high-corrosion area – where road salts are used, near the ocean, areas with industrial pollution, acid rain, etc., you should take extra care to prevent corrosion. In winter, hose off the underside of your vehicle at least once a month and be sure to clean the underside thoroughly when winter is over.
- When cleaning underneath the vehicle, pay particular attention to the components under the fenders and other areas that are hidden from view. Do a thorough job; just dampening the accumulated mud rather than washing it away will accelerate corrosion rather than prevent it. Water under high pressure and steam are particularly effective in removing accumulated mud and corrosive materials.
- When cleaning lower door panels, rocker panels and frame members, be sure that drain holes are kept open so that moisture can escape and not be trapped inside to accelerate corrosion.

Keep your garage dry

Don't park your vehicle in a damp, poorly ventilated garage. This creates a favorable environment for corrosion. This is particularly true if you wash your vehicle in the garage or drive it into the garage when it is still wet or covered with snow, ice or mud. Even a heated garage can contribute to corrosion unless it is well ventilated so moisture is dispersed.

Keep paint and trim in good condition

Scratches or chips in the finish should be covered with "touch-up" paint as soon as possible to reduce the possibility of corrosion. If bare metal is showing through, the attention of a qualified body and paint shop is recommended.

Bird droppings are highly corrosive and may damage painted surfaces in just a few hours. Always remove bird droppings as soon as possible.

Interior care

Interior general precautions

Prevent caustic solutions such as perfume and cosmetic oil, from contacting the interior parts because they may cause damage or discoloration. If they do contact the interior parts, wipe them off immediately. See the instructions for the proper way to clean vehicle interior surfaces.

NOTICE

- Never allow water or other liquids to come in contact with electrical/electronic components inside the vehicle as this may damage them.
- When cleaning leather products (steering wheel, seats etc.), use neutral detergents or low alcohol content solutions. If you use high alcohol content solutions or acid/alkaline detergents, the color of the leather may fade or the surface may get stripped off.

Cleaning the upholstery and interior trim

Vehicle interior surfaces (if equipped)

Remove dust and loose dirt from interior surfaces with a whisk broom or a vacuum cleaner. If necessary, clean interior surfaces with a mixture of warm water and mild non-detergent cleaner (test all cleaners on a concealed area before use).

Fabric (if equipped)

Remove dust and loose dirt from fabric with a whisk broom or vacuum cleaner. Clean with a mild soap solution recommended for upholstery or carpets. Remove fresh spots immediately with a fabric spot cleaner. If fresh spots do not receive immediate attention, the fabric can be stained and its color can be affected. Also, its fire-resistant properties can be reduced if the material is not properly maintained.

NOTICE

Using anything but recommended cleaners and procedures may affect the fabric's appearance and fire-resistant properties.

Leather (if equipped)

- Features of seat leather
 - Leather is made from the outer skin of an animal, which goes through a special process to be available for use. Since it is a natural product, each part differs in thickness or density. Wrinkles may appear as a natural result of stretching and shrinking depending on the temperature and humidity.
 - The seat is made of stretchable fabric to improve comfort.
 - The parts contacting the body are curved and the side supporting area is high which provides driving comfort and stability.
 - Wrinkles may appear naturally from usage. It is not a fault of the products.

NOTICE

- Wrinkles or abrasions which appear naturally from usage are not covered by warranty.
- Belts with metallic accessories, zippers or keys inside the back pocket may damage the seat fabric.
- Make sure not to wet the seat. It may change the nature of natural leather.
- Jeans or clothes which could bleach may contaminate the surface of the seat covering fabric.

- Caring for the leather seats
 - Vacuum the seat periodically to remove dust and sand on the seat. It will prevent abrasion or damage of the leather and maintain its quality.
 - Wipe the natural leather seat cover often with dry or soft cloth.
 - Use of proper leather protector may prevent abrasion of the cover and helps maintain the color. Be sure to read the instructions and consult a specialist when using leather coating or protective agent.
 - Light colored (beige, cream beige, etc.) leather is easily contaminated and the stain is noticeable. Clean the seats frequently.
 - Avoid wiping with wet cloth. It may cause the surface to crack.

- Cleaning the leather seats
 - Remove all contaminations instantly. Refer to the instructions below for removal of each contaminant.
 - Cosmetic products (sunscreen, foundation, etc.)

Apply cleansing cream on a cloth and wipe the contaminated spot. Wipe off the cream with a wet cloth and remove water with a dry cloth.
 - Beverages (coffee, soft drink, etc.)

Apply a small amount of neutral detergent and wipe until contaminations do not smear.
 - Oil

Remove oil instantly with absorbable cloth and wipe with stain remover used only for natural leather.
 - Chewing gum

Harden the gum with ice and remove gradually.

Cleaning the seat belt webbing

Clean the belt webbing with any mild soap solution recommended for cleaning upholstery or carpet. Follow the instructions provided with the soap. Do not bleach or re-dye the webbing because this may weaken the seat belt.

Cleaning the interior window glass

If the interior glass surfaces of the vehicle become fogged (that is, covered with an oily, greasy or waxy film), they should be cleaned with glass cleaner. Follow the directions on the glass cleaner container.

NOTICE

Do not scrape or scratch the inside of the rear window. This may result in damage to the rear window defroster grid.

Appendix

Vetrarakstur (íslenskur)	A-2
Snjór eða hálfka	A-2
Barnaöryggisbúnaður (CRS) (ÍSLENSKA).....	A-6

Vetrarakstur (íslenskur)

Hörð veðurskilyrði að vetri slíta hjólbörðum hratt og valda öðrum vandamálum. Til að lágmarka vandamál í vetrarakstri ættir þú að taka eftirfarandi ábendingum:

Snjór eða háлка

Þú þarft að halda nægilegri fjarlægð á milli ökutækisins þíns og ökutækisins fyrir framan þig.

Notaðu bremsustýringarnar varlega. Hröð hröðun, skyndileg hemlun og krappar beygjur geta verið mjög hættuleg vinnubrögð. Skyndileg hemlun á snævi eða snævi þakin vegi getur valdið því að ökutækið rennur.

Til að stýra ökutækinu þínu í djúpum snjó getur verið nauðsynlegt að festa hjólbarðakeðjur.

Vertu alltaf með neyðarbúnað. Hjólbarðakeðjur, dráttarólar eða keðjur, blys, neyðarblys, sandur, skófla, snúrur, rúðusköfu, hanskar, jarðdúkur, yfirklaði, teppi og svo framvegis er allt gagnlegt til að hafa við höndina.

Vetrardekk

⚠ Viðvörðun

Vetrardekk ættu að hafa sömu stærð og tegund og birgðadekk bílsins. Ef þú gerir það ekki getur bíllinn þinn verið minna stöðugur og minna öruggur í akstri.

Settu á radial dekk sem eru í sömu stærð og hleðslusviði og dekkinn sem eru þegar á bílnum þínum ef þú vilt keyra í snjónum. Settu vetrardekk á öll fjögur hjólin fyrir jafnt grip í snjó og háلكu. Á þurru slitlagi geta snjódekk ekki veitt eins mikið grip og verksmiðjudekk bílsins þíns. Leiðbeiningar um hámarkshraða ætti að athuga hjá söluaðila dekkja.

i Upplýsingar

Ekki setja á nagladekk án þess að athuga fyrst svæðisbundnar og landsbundnar reglur um takmarkanir á notkun þeirra.

Vetrardekk (ef þau eru til staðar)

- Sumarljós eru notuð til að ná sem bestum akstursegginleikum á þurrum vegum.
- Ef veðrið er undir 7°C eða ef ekið er á snjóþungum eða háلكu leiðum draga sumardekkinn úr hemlunar- og gripgetu vegna þess að þau missa mikið grip.
- Ef veðrið er undir 7°C eða þú ert að keyra á snævi eða ísilögðum vegum skaltu setja snjógúmmi eða allveðursdekk af sömu stærð og önnur dekk á ökutækinu þínu til að tryggja öruggan akstur. Snjó- og heilsársdekk eru með M+S merkingu.

- Þegar M+S dekk eru sett á skal nota flíkur með sama slitlagi og frá sama framleiðanda til að tryggja öruggan akstur.
- Þegar ekið er á M+S-dekkjum þar sem hámarkshiti er lægri en hefðbundin sumardekk ökutækisins skal fylgjast með leyfilegum hámarkshraða fyrir þessi dekk.

Dekkjakeðjur (vírakeðjur)



Þar sem brúnir á radial dekkjum eru lokaðari en í öðrum dekkjaflokkum eru þær næmar fyrir skemmdum vegna notkunar ákveðinna tegunda keðja. Því er mælt með því að nota snjódekk í stað dekkjakeðja. Notaðu aðeins opinbera HYUNDAI varahluti og fylgdu vandlega leiðbeiningunum á umbúðunum þegar þú setur upp hjólbarðakeðjur. Ef þú notar dekkjakeðjur rangt og veldur skemmdum á bílnum þínum mun framleiðandinn ekki greiða fyrir viðgerðina.

Þegar hjólbarðakeðjan er notuð skaltu aðeins setja hana á afturdekkinn.

⚠ Viðvörðun

Reyndar gæti notkun hjólbarðakeðja haft áhrif á meðhöndlun ökutækisins:

- Akið á hraða undir 30 km/klst (20 mph) eða ráðlögðum mörkum keðjuframleiðanda, hvort sem er lægra.
- Akið varlega og forðist ójöfnur, göt, krappar beygjur og aðrar hindranir á veginum sem geta valdið því að ökutækið hoppar.
- Forðist krappar sveigjur eða stýri með læstum hjólum.

ℹ Upplýsingar

- Settu hjólbarðakeðjur eingöngu í pörum og á afturdekkinn. Það skal tekið fram að uppsetning keðja á umbúðirnar veitir meiri drifkraft en kemur ekki í veg fyrir hliðarskrið.
- Ekki setja á nagladekk án þess að athuga fyrst svæðisbundnar og landsbundnar reglur um takmarkanir á notkun þeirra.

Dekkjakeðjur (bílasokkur)



Þar sem hliðar á geislamynduðum dekkjum eru þynnri eru þær næmar fyrir skemmdum vegna festingar á nokkrum gerðum af snjókeðjum. Til dæmis er mælt með því að nota blaðdekk í stað snjókeðja.

Ekki setja snjókeðjur á ökutæki með álfelgum; snjókeðjur geta skemmt rúllurnar. Ef nota þarf snjókeðjur skaltu nota AutoSock keðjuna (snjókeðju úr efni). Skemmdir á ökutæki þínu af völdum óviðeigandi notkunar á hjólbarðakeðjum falla ekki undir ábyrgð bílaframleiðandans.

Þegar hjólbarðakeðjan er notuð skaltu aðeins setja hana á afturdekkinn.

⚠ VARÚÐ

Athugaðu alltaf rétta festingu keðjanna eftir að hafa ekið um það bil 0,5 til 1 km (0,3 til 0,6 mílur) til að ganga úr skugga um að festingin sé örugg. Hertu eða settu keðjurnar aftur upp ef þær eru lausar.

Uppsetning keðja

Þegar hjólbarðakeðjur eru settar á skal fylgja leiðbeiningum framleiðanda og festa þær eins fast og hægt er. Ekið hratt (minna en 30 km/klst (20 mph)) með dekkjadropana uppsetta. Ef þú tekur eftir því að keðjurnar komast í snertingu við yfirbyggingu eða undirvagn skaltu stöðva þær og herða þær aftur. Ef þeir eru enn að snerta, hægðu á þér þar til þú heyrir minni hávaða. Fjarlægðu hjólbarðakeðjurnar um leið og þú byrjar að aka á opnum vegum.

Þegar snjókeðjur eru festar skal leggja kerfinu á jafnsléttu, í nokkurri fjarlægð frá umferð. Kveiktu á blikkljósi ökutækisins og settu þríhyrndan neyðarmerkjabúnað aftan í ökutækið (ef hann er til staðar). Settu ökutækið alltaf í P (park) stöðu, taktu stöðustýrið og slökktu á vélinni áður en snjókeðjurnar eru settar á.

ATHUGIÐ

Við meðhöndlun hjólbarðakeðja:

- Óviðeigandi stórar eða rangar keðjur geta skemmt kællilínur, fjöðrun, uppbyggingu og hjól ökutækisins.
 - Notaðu SAE "S" Class undirvagn eða snúrur.
 - Ef þú tekur eftir hávaða sem stafar af snertingu keðjanna við yfirbygginguna skaltu setja keðjuna aftur á til að forðast þessa snertingu.
 - Til að koma í veg fyrir skemmdir á líkamanum skaltu herða skiltin aftur eftir að hafa ekið 0,5-1,0 km (0,3-0,6 mílur).
 - Aldrei ætti að nota dekkjakeðjur á bíla sem eru með álfelgur. Ef þú þarft, notaðu keðju úr vír.
 - Gakktu úr skugga um að þú skemmir ekki bílinn þinn með því að setja á dekk keðjur sem henta ekki fyrir dekkinn þín.
 - Fyrir 18" dekk, notaðu keðjureipi sem er minna en 15 mm (0,59").
 - 20 tommu dekkin nota AutoSock (snjókeðju úr efni).
-

Barnaöryggisbúnaður (CRS) (ÍSLENSKA)

Hentugur hvers sætis fyrir belti og ISOFIX barnaöryggisbúnað samkvæmt reglum Sameinuðu þjóðanna (fyrir Evrópu).

(Upplýsingar fyrir notendur ökutækja og CRS framleiðendur)

- Já : Passar höfn í tilnefndum SIR flokki.
- Neibb : Hentar ekki fyrir viðhengi í tilnefndum SIR flokki.
- “-” : Á ekki við
- Taflan er reiknuð út fyrir ökutæki með vinstri stýri. Fyrir utan farþega í framsæti gildir borðið fyrir hægri stýrisbíla. Vinsamlega notaðu upplýsingar fyrir sætastöðu númer 3 fyrir ökutækissætið með hægri stýri.

Flokkar CRS		Sætisstaðir					
		1,2	3		4	5	6
			Loftpúði ON	Loftpúði OFF			
Alhliða CRS með belti	Allur fjöldahópur	-	Neibb	Já* F, R	Já F, R	Já F, R	Já F, R
Gerð i-stærð CRS	ISOFIX CRF : F2, F2X, R1, R2	-	Neibb	Neibb	Já F, R	Neibb	Já F, R
Barnakerra (ISOFIX hliðarhlið CRS)	ISOFIX CRF : L1, L2	-	Neibb	Neibb	Neibb	Neibb	Neibb
ISOFIX ungbarna* CRS (*: ISOFIX barn CRS)	ISOFIX CRF :R1	-	Neibb	Neibb	Já R	Neibb	Já R
ISOFIX smábarn CRS - lítil gerð	ISOFIX CRF: F2,F2X, R2,R2X	-	Neibb	Neibb	Já F, R	Neibb	Já F, R
ISOFIX smábarn CRS - stórt* (*: ekki aukastólar)	ISOFIX CRF :F3,R3	-	Neibb	Neibb	Já F, R	Neibb	Já F, R
Riser - minni breidd	ISO CRF : B2	-	Neibb	Neibb	Já	Neibb	Já
Riser - í fullri breidd	ISO CRF : B3	-	Neibb	Neibb	Já	Neibb	Já

Í Upplýsingar

F : Framvísandi, R: Bakvísandi

*: Til að setja upp Universal CRS þarf stærð 1. röð viðskiptavinarsætis að vera í miðju þess.

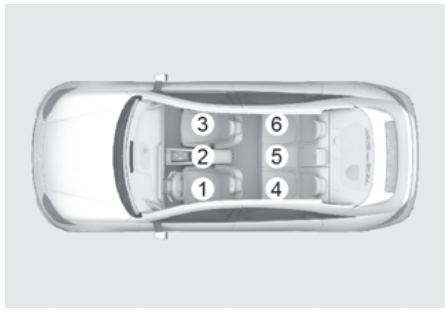
Sætisnúmer	Staðsetning í ökutækinu	Sætisstaðir
1	Framan til vinstri	
2	Miðja fram	
3	Á undan til hægri	
4	2. röð til vinstri	
5	2. röð miðja	
6	2. röð til hægri	

i Upplýsingar

? Ef höfuðrúðar ökutækisins koma í veg fyrir rétta uppsetningu á ERS, verður að stilla þann fyrir sætisstöðuna aftur eða fjarlægja alveg.

? Ekki nota farþegasætið að framan fyrir bakvísandi barnaöryggissæti nema líknarbelgurinn hafi verið gerður óvirkur.

Ráðlagður aðhaldsbúnaður fyrir barna (fyrir Evrópu)

Hæð barns eða massahópur	CRS Framleiðandi	CRS tegundarheiti	Tegund festingar	ECE viðurkenningarnúmer
40-83 cm	Britax Römer	BABY-SAFE 3 i-SIZE og Flex Base i-Sense	ISOFIX með stuðningsfóti (afturvísandi)	E1*129R03/04*0060
76-105 cm	Britax Römer	Trifix 2 i-stærð	ISOFIX og toptether	E1*129R02/06*0015
Hópur II	Britax Römer	KidFix 2 R	ISOFIX og ökutækisól, með CRS-beltastýringu	R44/04-E1-04301304
Hópur III	Graco	Grunn Booster	Ökutæki belti	R44/04-E11-0444165

Upplýsingar um CRS framleiðanda

Britax: www.britax.com

Graco: www.gracobaby.eu

Index

A

About "Getting started with your electric vehicle"	1-8
Accessing your vehicle	5-5
Immobilizer system	5-12
Smart key	5-5
Active air flap	6-55
Malfunction	6-55
Active sound design	6-56
Air conditioner compressor label	2-21
Air conditioning system	2-16
Airbag - supplemental restraint system	3-52
Additional safety precautions	3-72
Airbag warning labels	3-73
Do not install a Child Restraint System on the front passenger seat	3-66
How does the airbags system operate?	3-60
SRS care	3-72
What to expect after an airbag inflates	3-65
Where are the airbags?	3-54
Why didn't my airbag go off in a collision?	3-67
All Wheel Drive (AWD)	6-44
Emergency precautions	6-47
Appearance care	9-59
Exterior care	9-59
Interior care	9-64
Automatic climate control system	5-89
Automatic temperature control mode	5-91
Climate	5-91
Manual temperature control mode	5-93
System maintenance	5-103
System operation	5-101
Aux. Battery Saver+	1-65
Available front trunk weight	2-17

B

Barnaöryggisbúnaður (CRS)	A-6
Battery (12 V)	9-18
Battery capacity label	9-21
Battery recharging	9-21
For best battery service	9-20
Reset items	9-22
Before driving	6-3
Before entering the vehicle	6-3
Before starting	6-3
Blind-Spot Collision-Avoidance Assist (BCA)	7-40
Blind-Spot Collision-Avoidance Assist malfunction and limitations	7-47
Blind-Spot Collision-Avoidance Assist operation	7-43
Blind-Spot Collision-Avoidance Assist settings	7-42
Blind-Spot View Monitor (BVM)	7-72
Blind-Spot View Monitor malfunction	7-74

Blind-Spot View Monitor Operation	7-73
Blind-Spot View Monitor settings	7-73
Brake fluid	9-13
Checking the brake fluid level	9-13
Braking system	6-26
Anti-lock Brake System (ABS)	6-35
Auto Hold	6-32
Brake Assistant System (BAS)	6-43
Brake Disc Cleaning	6-35
Disc brakes wear indicator	6-27
Electronic Parking Brake (EPB)	6-27
Electronic Stability Control (ESC)	6-37
Emergency Stop Signal (ESS)	6-42
Good braking practices	6-44
Hill-Start Assist Control (HAC)	6-41
Multi-Collision Brake (MCB)	6-42
Power-assist brakes	6-26
Vehicle Stability Management (VSM)	6-40
Bulb wattage	2-14

C

Cabin air filter	9-15
Filter inspection	9-15
Filter replacement	9-15
Center Console overview (Left-hand drive)	2-6
Center Console overview (Right-hand drive)	2-8
Charging your electric vehicle	1-13
Charging your electric vehicle	1-13, 1-18
Stopping charging immediately	1-40
Using a DC Charger	1-28
Using a portable charger (ICCB)	1-33
Using an AC charger	1-25
Child Restraint System (CRS)	3-39
Installing a Child Restraint System (CRS)	3-42
Our recommendation:Children at middle position	3-39
Selecting a Child Restraint System (CRS)	3-40
Climate control additional features	5-108
Auto defogging system	5-108
Auto dehumidify	5-109
Automatic controls linked to climate control settings (for driver's seat)	5-111
Recirculating air when entering a tunnel	5-110
Recirculating air when washer fluid is used	5-110
Smart ventilation	5-111
Sunroof inside air recirculation	5-110
Cluster display	4-34
Cluster display control	4-34
View modes	4-34
Coolant	9-12
Countermeasures for accidents or fire	1-78
If the electric vehicle catches fire	1-78

If the electric vehicle is submerged 1-79
 If the electric vehicle needs towing 1-79
 Other precautions for electric vehicle accidents 1-80
Cruise Control (CC) 7-74
 Cruise Control operation 7-74

D

Declaration of conformity 2-21, 7-197
 Front corner radar/Rear corner radar 7-200
 Front radar 7-197
Digital side mirror (DSM) 5-37
 Adjusting the DSM cameras 5-39
 Displaying the guidelines 5-39
 DSM camera defroster 5-42
 DSM warnings and indicators 5-38
 Folding/Unfolding the DSM cameras 5-40
 Operating the digital side mirrors 5-38
 Setting the DSM screen brightness 5-42
 Switching to wide view when backing up 5-41
Dimensions 2-12
Door locks 5-13
 Automatic door lock and unlock features 5-20
 Child-protector rear door locks 5-21
 Deadlocks 5-20
 Operating door lock/unlock from inside the vehicle 5-17
 Operating door locks from outside the vehicle (Electric type) 5-16
 Operating door locks from outside the vehicle (Manual type) 5-15
 Operating door unlocks from outside the vehicle (Electric type) 5-14
 Operating door unlocks from outside the vehicle (Manual type) 5-13
Drive mode integrated control system (2WD) 6-48
 Drive mode 6-48
Drive mode integrated control system (AWD) 6-51
 Drive mode 6-51
 Drive modes characteristic 6-54
Driver assistance system notice 7-4
Driver Attention Warning (DAW) 7-66
 Driver Attention Warning malfunction and limitations 7-69
 Driver Attention Warning operation 7-68
 Driver Attention Warning settings 7-67
Driving your electric vehicle 1-66
 Checking electric vehicle driving information 1-68
 Starting and stopping the vehicle 1-66

E

Electric charging door 5-63
Electric vehicle specifications 2-13
Emergency commodity 8-24
 Fire extinguisher 8-24
 First aid kit 8-25

Tire pressure gauge	8-25
Triangle reflector	8-25
Explanation of scheduled maintenance items	9-11
Air conditioning refrigerant	9-11
Brake discs, pads, calipers and rotors	9-11
Brake fluid	9-11
Brake hoses and lines	9-11
Coolant	9-11
Cooling system	9-11
Drive shafts and boots	9-11
Reduction gear fluid	9-11
Steering gear box, linkage & boots/lower arm ball joint	9-11
Suspension mounting bolts	9-11
Exterior overview (Front View)	2-2
Exterior overview (Rear View)	2-3

F

Forward Collision Avoidance Assist (FCA)	7-4
Forward Collision-Avoidance Assist malfunction and limitations	7-24
Forward Collision-Avoidance Assist operation	7-12
Forward Collision-Avoidance Assist settings	7-9
Forward/Reverse Parking Distance Warning (PDW)	7-141
Forward/Reverse Parking Distance Warning malfunction and limitations	7-144
Forward/Reverse Parking Distance Warning operation	7-142
Forward/Reverse Parking Distance Warning settings	7-141
Forward/Side/Reverse Parking Collision-Avoidance Assist (PCA)	7-161
Parking Collision-Avoidance Assist malfunction and limitations	7-165
Parking Collision-Avoidance Assist operation	7-163
Parking Collision-Avoidance Assist settings	7-161
Forward/Side/Reverse Parking Distance Warning (PDW)	7-146
Parking Distance Warning Malfunction and Limitations	7-150
Parking Distance Warning Operation	7-147
Parking Distance Warning Settings	7-147
Front trunk	5-53
Fuses	9-31
Fuse/relay panel description	9-35
Instrument panel fuse replacement	9-32
Motor compartment panel fuse replacement	9-33

H

Hazard warning flasher	8-3
Head-up display	5-64
Head-up display information	5-65
Head-up display settings	5-64
Precautions while using the Head-up display	5-65
High Beam Assist (HBA)	5-80
High Beam Assist malfunction and limitations	5-82
High Beam Assist operation	5-81
High Beam Assist settings	5-80

Highway Driving Assist (HDA)	7-107
Highway Driving Assist Malfunction and Limitations	7-118
Highway Driving Assist operation	7-110
Highway Driving Assist settings	7-108
Hood	5-52
Closing the hood	5-53
Opening the hood	5-52

I

If the vehicle will not start	8-4
Confirm the EV battery is not low on the charge gauge	8-4
If you have a flat tire (with Tire Mobility Kit)	8-15
Components of the Tire Mobility Kit	8-17
How to adjust tire pressure	8-21
Introduction	8-15
Notes on the safe use of the Tire Mobility	8-16
Using the Tire Mobility Kit When a tire is flat	8-18
Important safety precautions	3-2
Airbag hazards	3-2
Always wear your seat belt	3-2
Control your speed	3-3
Driver distraction	3-2
Keep your vehicle in safe condition	3-3
Restrain all children	3-2
In case of an emergency while driving	8-3
If the vehicle stalls at a crossroad or crossing	8-3
If the vehicle stalls while driving	8-3
If you have a flat tire while driving	8-4
Instrument cluster	4-2
Cluster display messages	4-23
Gauges and meters	4-3
Instrument cluster control	4-3
Power/charge gauge	4-4
Reduction gear shift indicator	4-7
State of charge (SOC) gauge for high voltage battery	4-4
Warning and indicator lights	4-7
Integrated memory system	5-25
Recalling memory positions	5-26
Resetting the system	5-26
Seat easy access	5-27
Storing memory positions	5-26
Intelligent Front-Lighting System (IFS)	5-83
System malfunction and limitations	5-84
System operation	5-83
System setting	5-83
Intelligent Speed Limit Assist (ISLA)	7-59
Intelligent Speed Limit Assist malfunction and limitations	7-64
Intelligent Speed Limit Assist settings	7-60, 7-62
Interior features	5-113
Antenna	5-121

Bluetooth® Wireless Technology	5-123
Clock	5-119
Coat hook	5-119
Cup holder	5-113
Floor mat anchor(s)	5-120
Infotainment system	5-121, 5-122
Power outlet	5-115
Steering wheel remote controls	5-121
Sunvisor	5-114
USB charger	5-116
USB Port	5-121
Vehicle to load (V2L)	5-119
Voice recognition	5-123
Wireless smartphone charging system	5-117
Interior lights	5-75
Front lamps	5-76
Front trunk lamp	5-79
Glove box lamp	5-77
Interior lamp AUTO cut	5-75
Luggage compartment lamp	5-79
Mood lamp	5-77
Rear lamp	5-76
Vanity mirror lamp	5-77
Interior overview (Left-hand drive)	2-4
Interior overview (Right-hand drive)	2-5

J

Jump starting (12 V battery)	8-5
---	-----

L

Lane Following Assist (LFA)	7-102
Lane Following Assist Malfunction and Limitations	7-106
Lane Following Assist operation	7-103
Lane Following Assist settings	7-103
Lane Keeping Assist (LKA)	7-33
Lane Keeping Assist malfunction and limitations	7-37
Lane Keeping Assist operation	7-35
Lane Keeping Assist settings	7-34
Light bulbs	9-47
Front trunk light replacement	9-57
Headlight aiming (For Europe)	9-49
Headlight, position light, turn signal light, Daytime Running Light (DRL) replacement	9-48
High mounted stop light replacement	9-56
Interior light replacement	9-57
License plate light replacement	9-57
Rear combination light replacement	9-56
Side repeater light replacement	9-49
Lighting	5-69
Exterior lights	5-69

Interior lights	5-74
Load and speed capacity tires (for Europe)	2-16

M

Maintenance services	9-4
Owner maintenance precautions	9-4
Owner's responsibility	9-4
Manual Speed Limit Assist (MSLA)	7-57
Manual Speed Limit Assist operation	7-57
Mirrors	5-32
Inside rearview mirror	5-32
Outside rearview mirrors	5-33
Reverse parking aid	5-35
Motor compartment	9-3
Motor compartment Overview	2-11
Motor number	2-20

N

Navigation-Based Smart Cruise Control (NSCC)	7-97
Limitations of Navigation-based Smart Cruise Control	7-99
Navigation-based Smart Cruise Control operation	7-98
Navigation-based Smart Cruise Control settings	7-97

O

Open source software notice	2-21
Owner maintenance	9-5
Owner maintenance schedule	9-5

P

Pan-European eCall System (For EUROPE)	8-26
Information on data processing (For Europe)	8-29
Pan-European eCall System (For Europe)	8-31
Power trunk	5-55
Emergency trunk safety release	5-59
Operating the power trunk	5-56
Power trunk operating conditions	5-55
Resetting the power trunk	5-59

R

Rear Cross-Traffic Collision-Avoidance Assist (RCCA)	7-130
Rear Cross-Traffic Collision-Avoidance Assist malfunction and limitations	7-135
Rear Cross-Traffic Collision-Avoidance Assist operation	7-132
Rear Cross-Traffic Collision-Avoidance Assist settings	7-131
Rear Occupant Alert (ROA)	5-22
Declaration of conformity	5-25
System operation	5-23
System setting	5-22
Rear View Monitor (RVM)	7-120

Rear View Monitor malfunction and limitations	7-123
Rear View Monitor operation	7-121
Rear View Monitor settings	7-120
Recommended lubricants and capacities	2-18
Reduction gear	6-9
Cluster display messages	6-13
Good driving practices	6-14
Reduction gear operation	6-9
Reduction gear fluid	9-14
Regenerative braking system (paddle shifter)	6-15
One Pedal Driving	6-17
Regenerative braking system limitations	6-16
Using i-PEDAL	6-18
Using regenerative braking system	6-16
Remote Smart Parking Assist 2 (RSPA 2)	7-169
Remote Smart Parking Assist malfunction and limitations	7-190
Remote Smart Parking Assist operation	7-172
Remote Smart Parking Assist settings	7-171
Reverse Parking Collision-Avoidance Assist (PCA)	7-153
Reverse Parking Collision-Avoidance Assist malfunction and limitations	7-156
Reverse Parking Collision-Avoidance Assist operation	7-155
Reverse Parking Collision-Avoidance Assist settings	7-154

S

Safe Exit Warning (SEW)	7-52
Safe Exit Warning malfunction and limitations	7-55
Safe Exit Warning operation	7-54
Safe Exit Warning settings	7-53
Scheduled maintenance services	9-7
Maintenance under severe usage conditions	9-10
Normal maintenance schedule	9-8, 9-9
Seat belts	3-28
Additional seat belt safety precautions	3-36
Care of seat belts	3-38
Seat belt restraint system	3-31
Seat belt safety precautions	3-28
Seat belt warning light	3-29
Seats	3-4
Air ventilation seats	3-26
Front seats	3-8
Headrest	3-18
Rear seats	3-16
Safety precautions	3-7
Seat warmers	3-22
Smart Cruise Control (SCC)	7-78
Smart Cruise Control malfunction and limitations	7-91
Smart Cruise Control operation	7-80
Smart Cruise Control settings	7-79
Smart recuperation system	6-19
Front sensors (Front radar)	6-22

Pausing smart recuperation system	6-21
Precautions for smart recuperation system	6-23
Smart recuperation level settings	6-21
Smart recuperation system on/off	6-20
Smart recuperation system operating condition	6-20
System warning due to sensor problems	6-22
Smart trunk	5-60
Deactivating smart trunk	5-61
Detecting area	5-62
Using smart trunk	5-60
Special driving conditions	6-56
Driving at night	6-57
Driving in flooded areas	6-58
Driving in the rain	6-58
Hazardous driving conditions	6-56
Highway driving	6-59
Rocking the vehicle	6-57
Smooth cornering	6-57
Start/Stop button	6-4
Remote start	6-8
Start/Stop button position	6-5
Starting the vehicle	6-6
Turning off the vehicle	6-7
Steering wheel	5-28
Heated steering wheel	5-30
Horn	5-30
Motor Driven Power Steering (MDPS)	5-28
Tilt/Telescopic steering	5-29
Steering Wheel Control Overview	2-10
Storage compartment	5-112
Center console storage	5-112
Glove box	5-113
Surround View Monitor (SVM)	7-124
Surround View Monitor malfunction and limitations	7-129
Surround View Monitor operation	7-126
Surround View Monitor settings	7-124

T

Theft-alarm system	5-21
Tire Pressure Monitoring System (TPMS)	8-9
Changing a tire with TPMS	8-13
Check tire pressure	8-9
Low tire pressure position and tire pressure telltale	8-11
Low tire pressure warning light	8-11
Tire pressure monitoring system	8-10
TPMS (Tire Pressure Monitoring System) malfunction indicator	8-12
Tire specification and pressure label	2-20
Tires and wheels	2-15, 9-23
Check tire inflation pressure	9-24
Low aspect ratio tires	9-30

Recommended cold tire inflation pressures	9-23
Tire care	9-23
Tire maintenance	9-27
Tire replacement	9-26
Tire rotation	9-25
Tire sidewall labeling	9-27
Tire traction	9-27
Wheel alignment and tire balance	9-25
Wheel replacement	9-26
Towing	8-22
Removable towing hook	8-23
Towing service	8-22
Trailer towing	6-64
Driving with a trailer	6-69
If you decide to pull a trailer	6-65
Maintenance when towing a trailer	6-72
Trailer towing equipment	6-68

U

UAE eCall System (For UAE)	8-35
eCall certification label	8-43
Information on data processing (For UAE)	8-38
UAE eCall System (For UAE)	8-40
Understanding your electric vehicle	1-9
Characteristics of your electric vehicle	1-9
Other precautions for electric vehicle management	1-12
Precautions when using the high voltage battery	1-11
Using EV mode functions	1-41
Checking energy information	1-43
Checking the EV mode screen configuration	1-41
Setting a battery discharging limit when using Vehicle to Load (V2L)	1-50
Setting electric vehicle specialized functions	1-51
Setting scheduled charging and climate	1-48
Setting the next departure time	1-46
Using V2L function	1-57
Safety precautions when using the V2L function	1-57
Solving V2L problems	1-63
Using electricity inside the vehicle	1-62
Using electricity outside the vehicle	1-60

V

Vehicle certification label	2-19
Vehicle Identification Number (VIN)	2-19
Vehicle settings (infotainment system)	4-39
Setting your vehicle	4-39
Vehicle system OTA update	5-66
Approving software update	5-66
Downloading software	5-66
Preparing software update	5-67

Updating software	5-67
Vehicle weight	6-72
Overloading	6-73
Vehicle weight and luggage volume	2-17
Vetrarakstur	A-2
Snjór eða hálsa	A-2

W

Washer fluid	9-14
Checking the washer fluid level	9-14
Wide sunroof	5-48
Windows	5-43
Power windows	5-45
Windshield defrosting and defogging	5-105
Defogging logic	5-106
Rear window defroster	5-107
To defog inside windshield	5-105
To defrost outside windshield	5-106
Winter driving	6-59
Snow or icy conditions	6-59
Winter precautions	6-63
Wiper blades	9-16
Blade inspection	9-16
Blade replacement	9-16
Wipers and washers	5-86
Front windshield washers	5-88
Front windshield wipers	5-86

SG