

IONIQ 6

Emergency Response Guide

Contents

1. Identification / recognition	2
2. Immobilization / stabilization / lifting	6
3. Disable direct hazards / safety regulations	7
4. Access to the occupants	10
5. Stored energy / liquid / gases / solids	13
6. In case of fire	16
7. In case of submersion	20
8. Towing / Transportation / storage	21
9. Important additional information	24

1. Identification / recognition

Initial Response: Identify, Immobilize and Disable

The following procedures should be used whenever you are dealing with a IONIQ 6 at an emergency scene. However, all operations should be consistent with your department's standard operating procedures, guidelines, and any applicable laws. When an EV is damaged in a crash, the high voltage safety systems may have been compromised and present a potential high voltage electrical shock hazard. Exercise caution and wear appropriate personal protective equipment (PPE) safety gear, including high voltage safety gloves and boots. Remove all metallic jewelry, including watches and rings.

Identify

The IONIQ 6 is an electric vehicle. Emergency responders should respond to emergency scenarios involving the IONIQ 6 accordingly, exercising extreme care and caution to avoid contact with the high voltage system within the vehicle.

1. Identification / recognition

1.1 Identifying a Hyundai IONIQ 6

“IONIQ 6” on tail gate

- The HYUNDAI IONIQ 6 can be easily identified by the Exterior design and IONIQ 6 logo on the tail gate.
- The IONIQ 6 logo may be missing or hidden after a crash due to damage to the vehicle. Always be sure to utilize additional methods of identification before determining that the vehicle is not an electric car.



Charging Port

- The charging port is located on the rear right side.

#Note : The doors must be un-locked to open the charge port door.

How to open the charging port

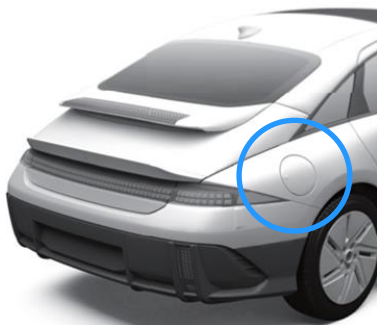

Charging Port

Unlock charging door in emergency

Put your finger between the charge door and the vehicle body and then open the charging door.

1. Identification / recognition

1.1 Identifying a Hyundai IONIQ 6

VIN Label

The VIN (Vehicle Identification Number) identifies an electric car with a “A” or “B” or “C” or “D” displayed in the 8th position, as shown in the below picture.

The VIN can be found:

- 1) Underneath the front passenger seat (or driver seat).
- 2) On the vehicle certification label attached to the driver’s side (or passenger) center pillar.

XXXXXXXX**A/B/C/D**XXXXXX

← 8th position

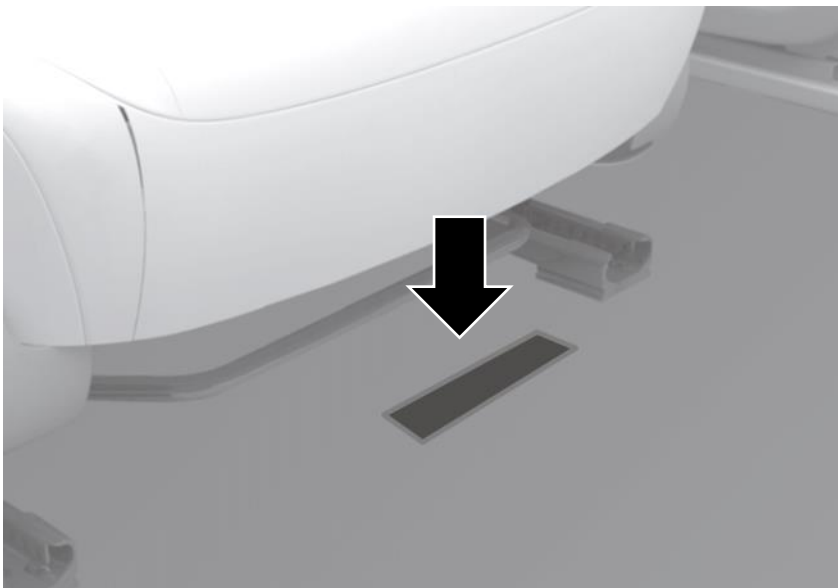

1. Identification / recognition

1.1 Identifying a Hyundai IONIQ 6

Motor Compartment and underside

IONIQ 6 has a logo on the tail gate and an identifying exterior design.

Additionally, there are orange colored high-voltage electrical cables in the motor compartment and underside



2. Immobilization / stabilization / lifting

2.1 Immobilization

The next step is to immobilize the vehicle to prevent any accidental movement that can endanger response personnel or civilians. When the IONIQ 6 is damaged in a crash, the vehicle may appear to be shut off when it is not due to no engine sounds.

When the "READY" mode light is illuminated on the Instrument Panel, the vehicle can move silently using the electric motor. Responders should approach the vehicle from the sides and stay away from the front or rear as they are potential paths for vehicle movement. Be sure to immobilize the vehicle in the following manner.

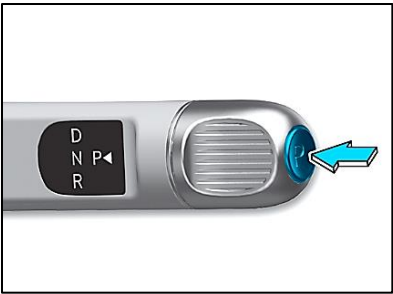

Press park (P) position



Engage Parking Brake

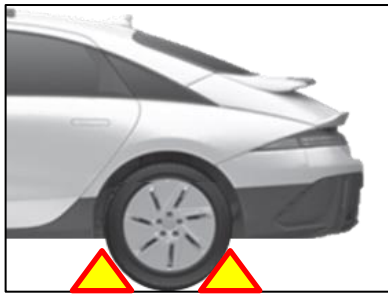

Chock the Wheels

* The actual image of vehicle may differ from the illustration

2.2 Vehicle Stabilization

Use standard stabilization(lift) points, as shown beside. Always be sure to connect to a structural member of the vehicle and avoid placing cribbing under high voltage cables, and other areas not normally considered acceptable.

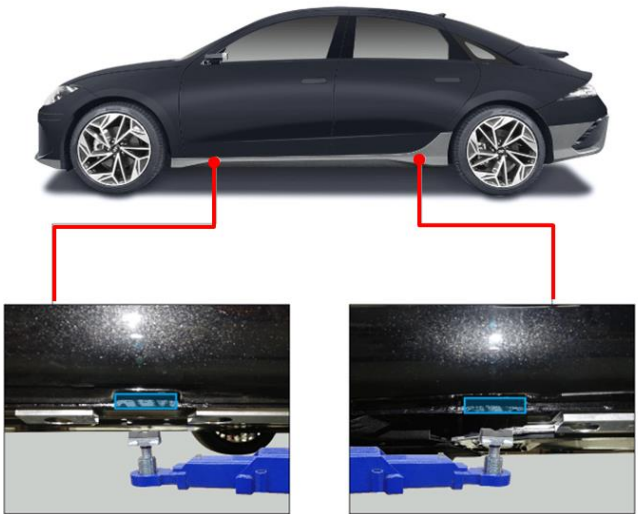

3. Disable direct hazards / safety regulations

The final step in the initial response process, conducted after immobilizing the vehicle, is to disable the vehicle, its SRS components and the high voltage electrical system. To prevent current flow through the system, use the following procedure to disable the vehicle.



3.1 Disabling the System - Smart Key System and “POWER”

START/STOP Button

1. Confirm the status of the READY light on the instrument panel. If the  READY light is illuminated, the vehicle is ON.
 - a) If the READY light is NOT illuminated, the vehicle is off. Do not push the “POWER” START/STOP button because the vehicle may start (go into READY mode).
 - b) To turn OFF the system, press the 'P'(Park) button, and press the POWER button.

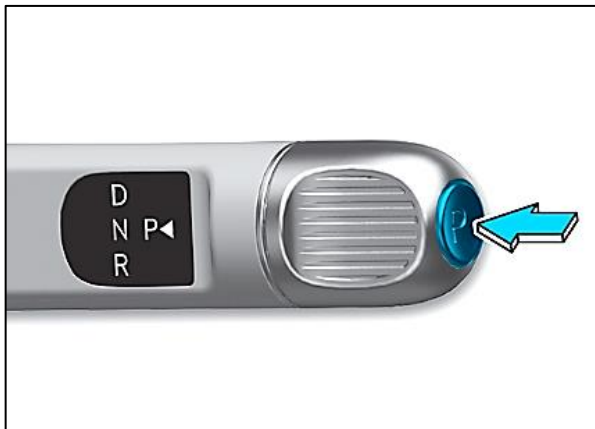

Press park (P) position

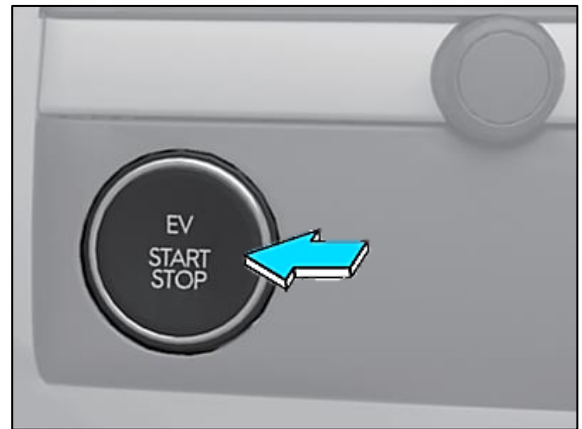

“POWER” START/STOP Button

3. Disable direct hazards / safety regulations

Without depressing the brake pedal

Pressing POWER button	Button Position/LED	Vehicle condition
One time	ACC/ON	Electrical accessories are operational.
Two times	ON/ON	The warning lights can be checked before the vehicle is started.
Three times	OFF	Off

While depressing the brake pedal

Pressing POWER button	Button Position/LED	Vehicle condition
One time	-	Ready to drive

2. If necessary, lower the windows, unlock the doors and open the tail gate as required, before disconnecting the 12V battery. Once the 12V battery is disconnected, power controls will not operate. (Refer to below “4. a)” for 12V battery disconnection)

3. Before disconnecting the 12V battery, remove the Smart Key at least 2 meters away from the vehicle to prevent accidental restart.

4. Follow the procedure below to disable the high voltage battery:

a) Disconnect the 12V auxiliary battery negative (-) terminal.

1) Remove the battery cover ①

2) Disconnect the 12V battery negative terminal ②

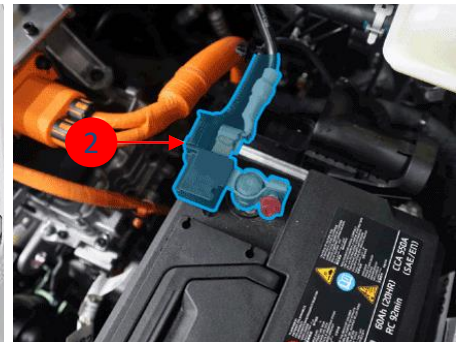
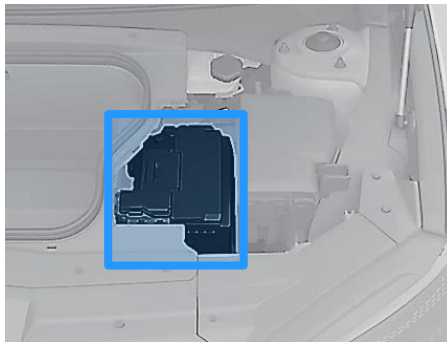
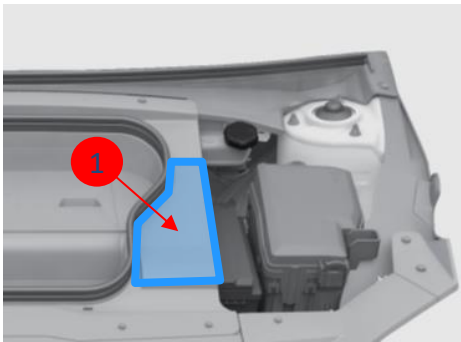

3. Disable direct hazards / safety regulations

b) Remove the Junction block upper cover (A) in the PE room

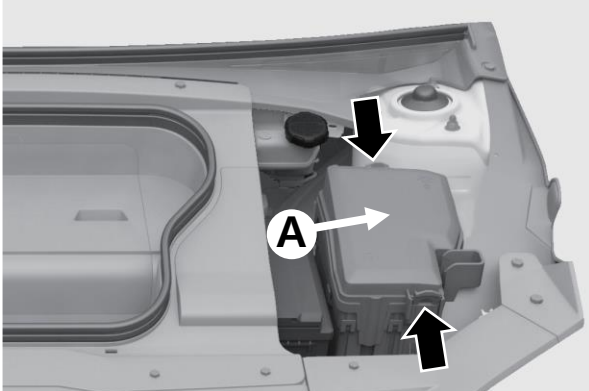

c) Disconnect the High voltage cut-off Switch

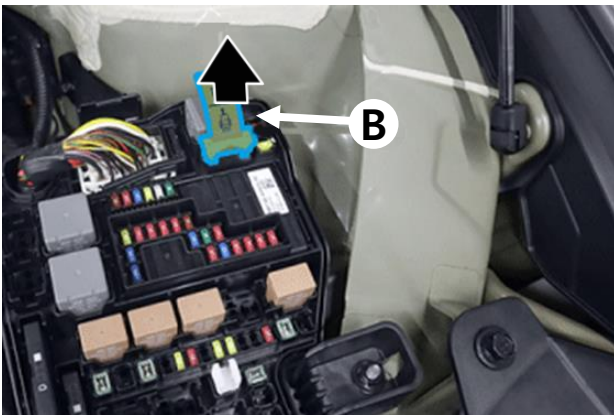

B : High voltage cut-off Switch

CAUTION Electrocutation Risk

- Before engaging in any emergency response procedures, ensure the vehicle is disabled and wait 5 minutes to allow the capacitor in the high voltage system to discharge to avoid electrocution.
- Exposed cables or wires may be visible inside or outside the vehicle. Never touch the metal chassis wires, cables, connectors, or any electric components before disabling the system, and/or shorted to the vehicle chassis.

Failure to follow these instructions will lead to serious bodily injury or death by electrocution.

4. Access to the occupants

4.1 Extraction Operations

The IONIQ 6 is an electric model. Because of the high voltage components contained therein, first responders should pay special attention when they extract occupants in the car. Before performing any extraction operations, the first responders should "Identify, Immobilize and Disable" the vehicle as discussed in sections on emergency procedures.

4.2 Vehicle Stabilization

Use standard stabilization (lift) points, as shown beside. Always be sure to connect to a structural member of the vehicle and avoid placing cribbing under high voltage cables, and other areas not normally considered acceptable.

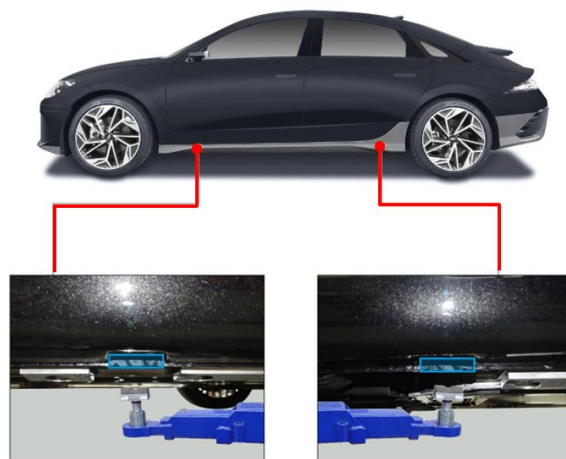

4.3 How to open the door manually

(When airbags are deployed, the door handles pop-out automatically. But the door handles may not pop-out under certain conditions.)

1. Push the front side inwards.
2. Rear Side of door handle pop-out.
3. Pull the door handle to open the door.

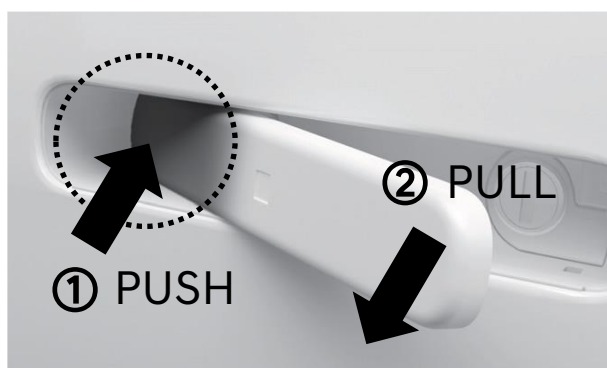

4.3 Extraction tools and procedure

When responding to an incident involving a IONIQ 6, we recommend that the first responders follow their organization's standard operating procedures for dealing with vehicle emergencies.





When the first responders cut the vehicle, they should always pay special attention to the airbag system, orange colored high voltage cables and other high voltage components so that the parts are not damaged and to prevent a risk of explosion.

4. Access to the occupants

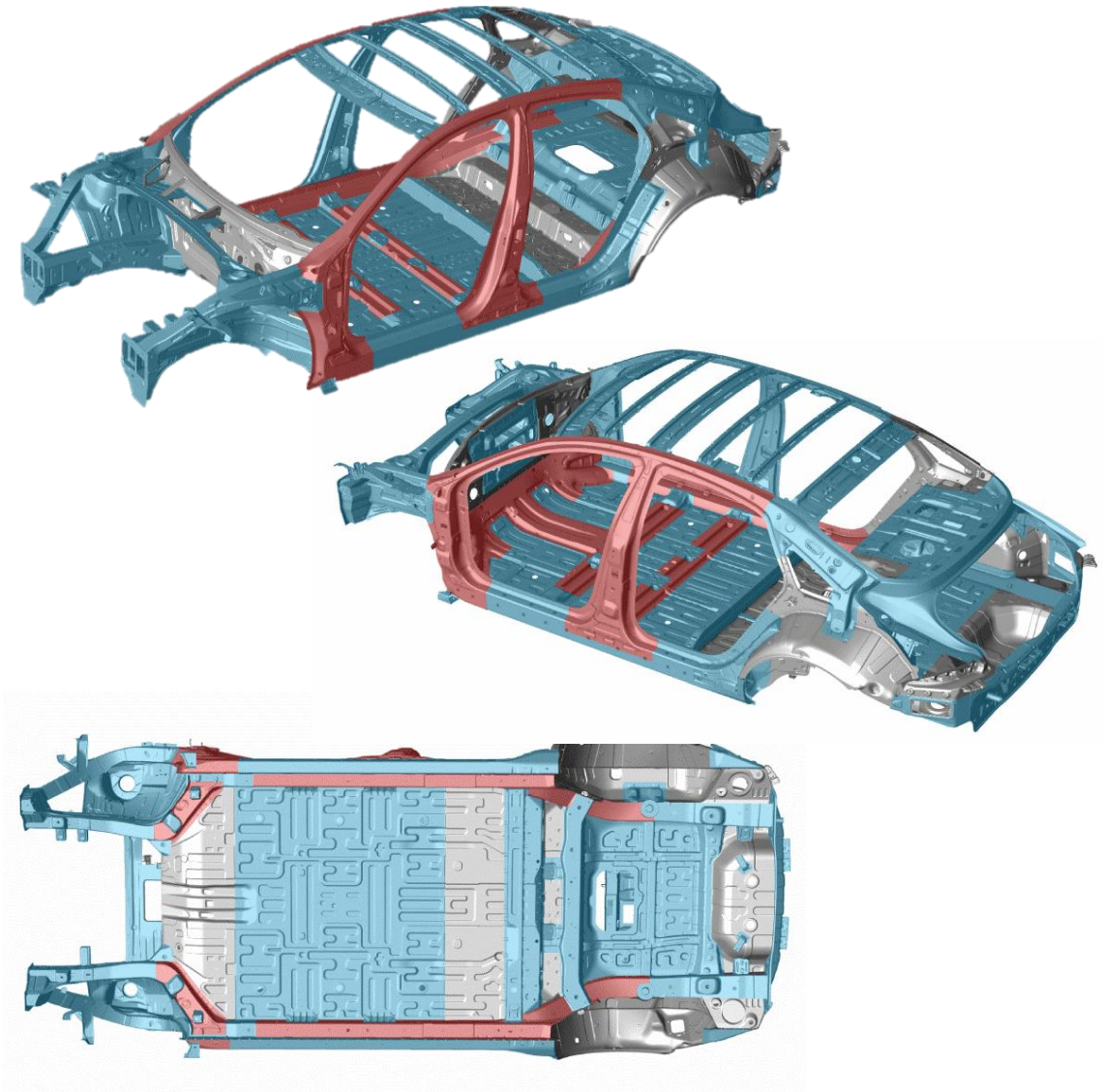
4.4 Location of ultra-high strength steel

In these images, high strength steel is used in the areas colored in blue and ultra-high strength steel is used in the red colored areas. Depending on the tools used, ultra high strength steel can be challenging or impossible to cut. If necessary, use a workaround technique.











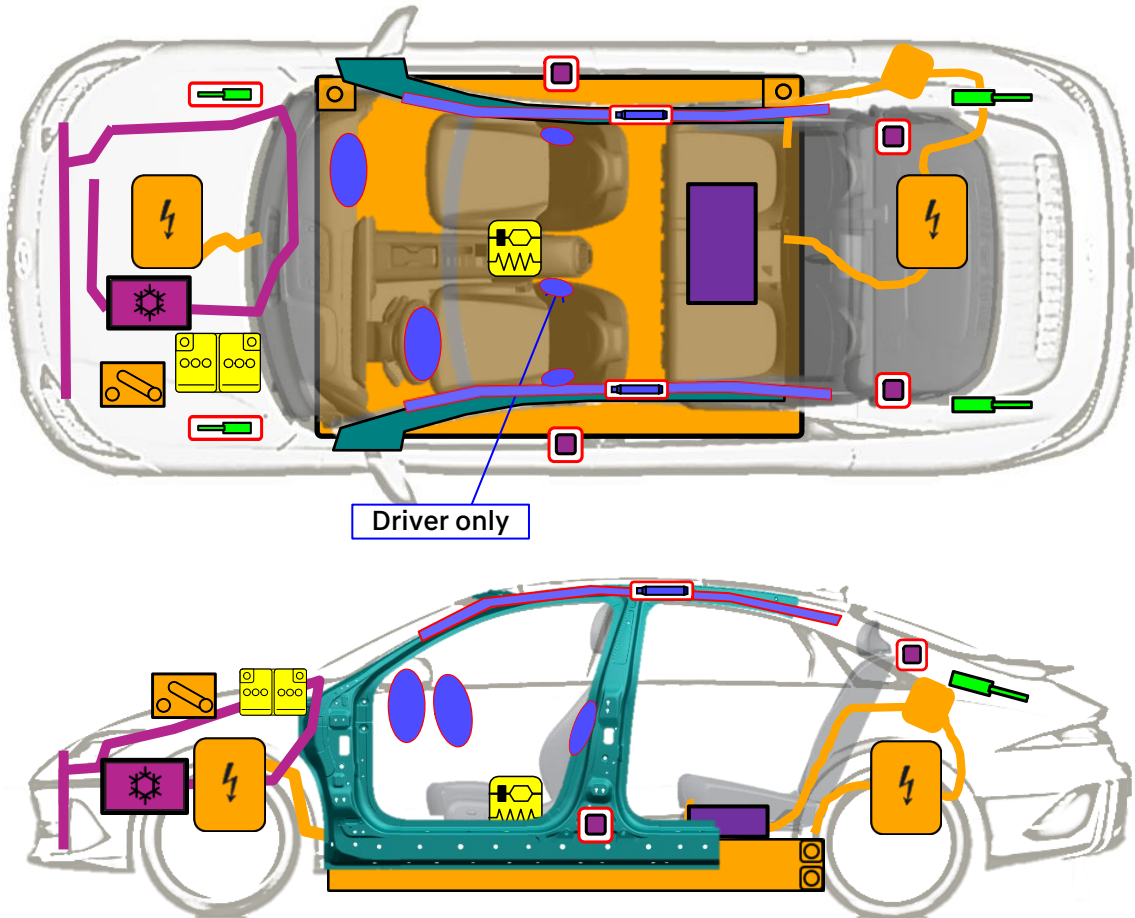



-  Mild steel
-  High strength steel
-  Ultra-high strength steel (Hot stamping)
-  Aluminum ally

4. Access to the occupants

4.5 Occupants rescue guide

When dealing with the emergency situation, check the components as below.



 Supplemental Restraint System Control Module (SRSCM)	 Airbag	 Airbag Gas Inflators
 High voltage cable	 12V Battery	 Air-conditioning line
 High voltage disconnect	 OBC (On - Board Charger)	 Ultra-High Strength Steel
 High Voltage Battery	 Air-conditioning component	 Seat belt pretensioner

5. Stored energy / liquid / gases / solids

5.1 High voltage system

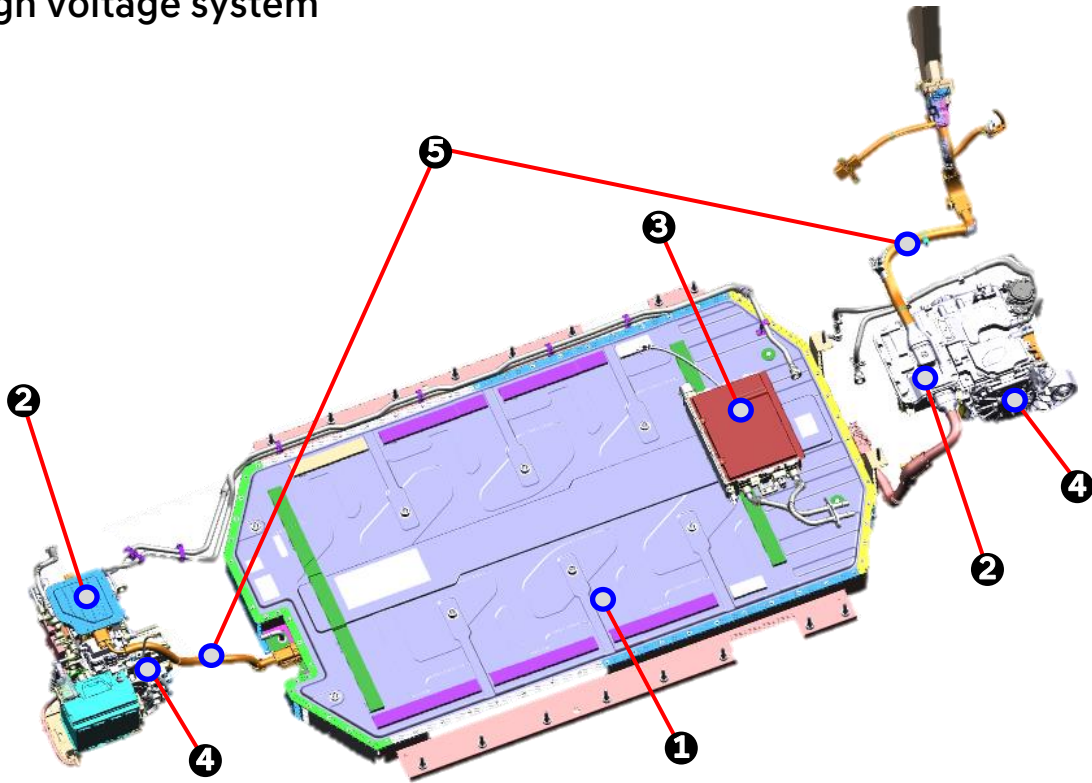

1	High voltage battery		Supplies electric energy to traction motor and stores generated electric energy.
2	High-voltage Junction box (FRT, RR)		It supplies electricity from battery to the inverter, LDC, air conditioner compressor, etc...
3	ICCU (OBC + LDC)		Integrated Charging Control Unit (OBC + LDC) OBC (On-Board Charger) : Battery charging equipment (AC→DC) LDC (Low Voltage DC-DC Converter) : Charge 12V auxiliary battery
4	Drive System	Motor	When current flows through the coil, it generates a rotating magnetic field and generates motor torque.
		EV Transmission	Increases Motor Torque and increased Torque is transferred to the wheels.
		Inverter	DC → AC (from battery to traction motor) AC → DC (charge using regenerative braking)
5	High-Voltage Cable		The high-voltage cabling is orange per the SAE standard.

5. Stored energy / liquid / gases / solids

5.1 High voltage system

High voltage battery

The HV Lithium ion battery supplies and stores electric energy, to the traction motor, and is located under the IONIQ 6 chassis.

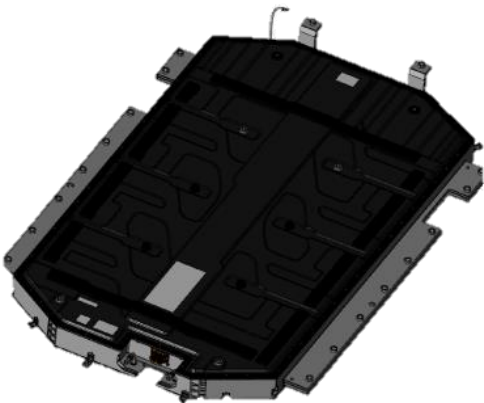

12V auxiliary battery

The 12V auxiliary battery is located in the right side of the electric motor room, and powers all of the vehicle's standard electronics like radio, lights, door locks, power windows, etc.



※ Specification

Motor	Type	Permanent magnet synchronous motor
	Max. Output (kW)	2WD : 107kW (standard) 2WD & AWD : 168kW & 239kW (long range)
	Max Torque (Nm)	2WD : 350Nm AWD : 605Nm
ICCU	Max. Output (kW)	10.5kW
High Voltage Battery	Type	Lithium-ion
	Rated Voltage (V)	Long range : 697v Standard : 480v
	Energy (kWh)	Long range : 77kWh Standard : 53kWh
	Quantity for Pack (Cell)	Long range : 384 cells Standard : 264 cells

5. Stored energy / liquid / gases / solids

5.2 High voltage orange cabling

The High Voltage cabling is orange, per Society of Automotive Engineers (SAE) standards. Cables run under the floor of the vehicle and connect the High Voltage Battery to the ICCU, Motor, A/C compressor and other High Voltage components located towards the front and rear of the vehicle.

The presence of orange cables under the hood, in the under-floor battery compartment, or HV cables under the car, identifies the vehicle as an electric vehicle.

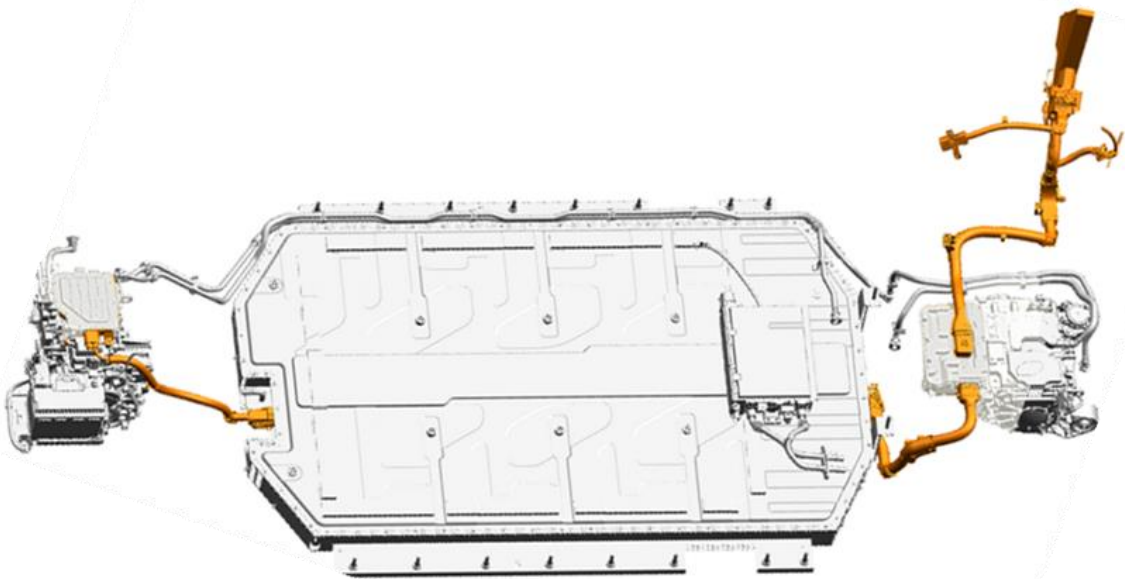

CAUTION

- Never cut or disconnect the high voltage orange cabling and connectors without first disabling the HV system. (refer to page 7)
- Exposed cables or wires may be visible inside or outside the vehicle. Never touch the metal chassis wires, cables, connectors, or any electric components before disabling the system, and; or shorted to the vehicle chassis.

Failure to follow these instructions will lead to serious bodily injury or death by electrical shock.

6. In case of fire

6.1 Firefighting Operations

Strict precautions must be taken while conducting firefighting operations due to following Reasons:

- Lithium-ion batteries contain electrolyte that can vent, ignite and produce sparks when subjected to temperatures above 300°F.
- Vehicle may burn rapidly with a flare-burning effect.
- Even after the high-voltage battery fire appears to have been extinguished, renewed or delayed fire can occur.
 - Use a thermal imaging camera to ensure the high voltage battery is completely cooled before leaving the incident.
 - Always advise second responders that there is a risk of the battery re-igniting.
 - In a fire, submersion or a collision that has compromised the high voltage battery, always store it in an open area with no exposures within 50 feet.
 - If there is no suitable open area, it can be stored in a barrier made of earth, steel, cement or masonry.
- A burning battery could release hydrogen fluoride, carbon monoxide, and carbon dioxide gasses. Use NIOSH/MSHA approved full-face self-contained breathing apparatus (SCBA) with full protective gear. Even if the high-voltage battery pack is not directly involved in a vehicle fire, approach the vehicle very carefully.

6.2 Extinguishers

- Small fires that do not involve the high voltage battery should be extinguished using an ABC fire extinguisher. (ex. Fire caused by wiring harnesses, electrical components, etc.)
- Do not attempt to extinguish fires that involve the high voltage battery with small amounts of water as this can result in electrocution. Fires that involve the high voltage battery should be extinguished using large amounts of water (Max 10,000 liter) to cool the high voltage battery. Fire fighters should not hesitate to pour larger amounts of water on the vehicle in such scenarios. Make sure the battery is fully cooled to avoid fire re-ignition.

6. In case of fire

6.3 How to deal with the situation

Fire

Extinguish the fire with a large amount of water. Don't use seawater or salt water. It can generate the toxic vapor or cause the reignition.

Damaged battery or Fluid leak*

Disconnecting 12V Battery (-) terminal, Disabling the high voltage system, Neutralize the battery by applying a large volume of water. (It doesn't discharge the battery)

Battery discharging

*If electrolyte solution leakage, or any damage to the H.V battery casing is observed

6.3.1 Vehicle fire

- Use a large volume of water (max. 10,000 liter). The water must cool down the battery.
- If water is put into the high voltage battery casing, it will be better to cool down the battery. (But never attempt to penetrate the HV battery or its casing to apply water.)



- Soaking the vehicle in the container filled with water can be an effective way to extinguish the fire.

6. In case of fire

6.3.2 High Voltage Battery Damage and Fluid Leaks

If electrolyte solution leakage, or any damage to the Lithium ion battery casing is observed, the first responders should attempt to neutralize the battery by applying a large volume of water to the battery pack while wearing appropriate Personal Protective Equipment (PPE). The neutralization process helps stabilize the thermal condition of the battery pack but does not discharge the battery.

- Do not put any smoke, spark, flame around the vehicle.
- Do not touch or step on the spilled electrolyte.
- If electrolyte leak occurs, wear appropriate solvent resistant PPE and use soil, sand, or a dry cloth to clean up the spilled electrolyte. Be sure to adequately ventilate the area.

CAUTION Electrolyte Irritation

The high voltage battery contains electrolyte solution. To avoid exposure to electrolyte solution and serious personal injury, always wear appropriate solvent resistant PPE (Personal Protective Equipment) and SCBA (Self-Contained Breathing Apparatus).

- Electrolyte solution is an eye irritant - In the event of contact with eyes, rinse with plenty of water for 15 minutes.
- Electrolyte solution is a skin irritant. Therefore, in the event of contact with skin, wash off with a soap.
- Electrolyte liquid or fumes coming into contact with water will create vapors in the air from oxidization. These vapors may irritate skin and eyes. In the event of contact with vapors, rinse with plenty of water and consult a doctor immediately.
- Electrolyte fumes (when inhaled) can cause respiratory irritation and acute intoxication. Inhale fresh air and wash mouth with water. Consult a doctor immediately.

6. In case of fire

6.4 High Voltage Battery re-ignition by stranded energy

Damaged cells in the high voltage battery can experience thermal runaway* and reignition. To prevent reignition, the first responder and second responder need to be aware of the risk of stranded energy* which remains in the damaged cells and lead to reignition.

*Thermal runaway : The originating cause of thermal runaway is generally short-circuiting inside a battery cell and a resulting increase in the cell's internal temperature. Battery produces heat with thermal runaway and it can spread from one battery cell to many cells, in a domino effect.

*Stranded energy : Energy remains inside any undamaged battery cells after the accident. That stranded energy can cause a high voltage battery to reignite multiple times after firefighters a fire.

How to prevent reignition (Mitigating stranded energy risk)

Use a thermal imaging camera to ensure the high voltage battery is completely cooled before leaving the incident.

Always advise second responders that there is a risk of the battery re-igniting.

1. 12V battery (-) terminal disconnection (To depower battery management system)
2. High voltage shut off
*refer to page 7-9
3. Discharging the high voltage battery
*refer to page 22-23

7. In case of submersion

7.1 Submerged or Partially Submerged Vehicles

Some emergency responses can involve a submerged vehicle. IONIQ 6 that is submerged does not have high-voltage components on the vehicle's body or framework. It is safe to touch the vehicle's body or framework if there is no severe damage to the vehicle, whether it is in water or on land.

In the event of the vehicle is submerged or partially submerged, remove the vehicle from the water before attempting to disable the vehicle. Drain the water from the vehicle. Use one of the methods described in page 7-9 to disable the vehicle.

Then, discharge the battery by referring to page 22-23.

CAUTION

- If severe damage causes high voltage components to become exposed, responders should take appropriate precautions and wear appropriate insulated personal protective equipment.
- Do not attempt to remove a safety plug while the vehicle is in water.

Failure to follow these instructions can lead to death or serious injury by electrocution.

8. Towing / Transportation / storage

8.1 Towing and Transportation

In the event of an accident, the high voltage system must be disabled. The safety plug must be removed from the high voltage battery according to the method described in page 7-9 to disable the vehicle.

Towing the IONIQ 6 Vehicle is not different from towing a conventional electric vehicle. If emergency towing is necessary, we recommend having it done by an authorized Hyundai dealer or a commercial tow-truck service. Proper lifting and towing procedures are necessary to prevent damage to the vehicle.

The use of wheel dollies or flatbed is recommended.

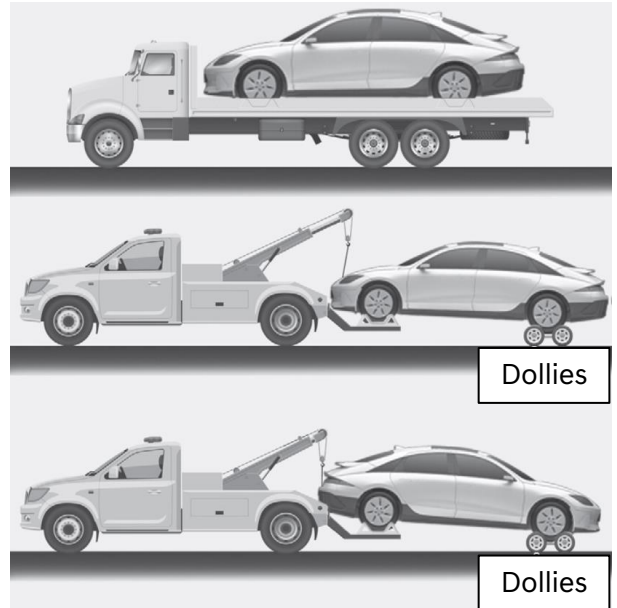

CAUTION

- Do not tow with sling-type equipment. Use wheel lift or flatbed equipment.
- Never tow the vehicle with the front wheels on the ground (forward or backward), as this may cause fire or damage to the motor.

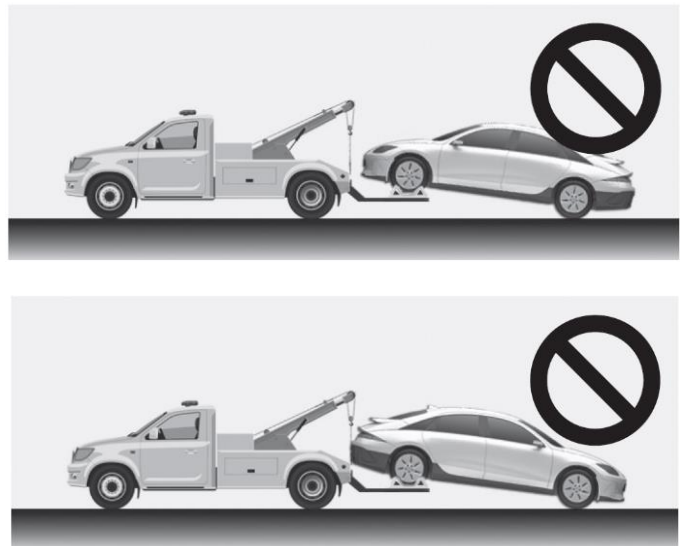

8. Towing / Transportation / storage

8.2 Storage of damaged vehicle with the damaged battery

- Drain fluids and water, then disconnect the negative (-) terminal of the 12V battery before storing a damaged vehicle.
 - Place the vehicle in an open space away from any structure, vehicle, or building.
 - Then, keep on eye on the vehicle until the discharging procedures are completed.
 - If the battery can be removed from the vehicle by moving the vehicle on the lift, remove and discharge the battery.
 - If the battery can't be removed, set the water pool and pouring water until the entire battery is submerged. (Water pool condition : 2% salt water)
 - Wait for at least 3 days in salt water.
 - Then, drain the water by removing the BMU service cover (A) under side of battery pack.
 - If the high voltage battery cannot be removed or the vehicle cannot be flooded, store the vehicle with waterproof cover.
- ※ Waterproof cover : size/material that can prevent water from entering the battery



Battery discharging

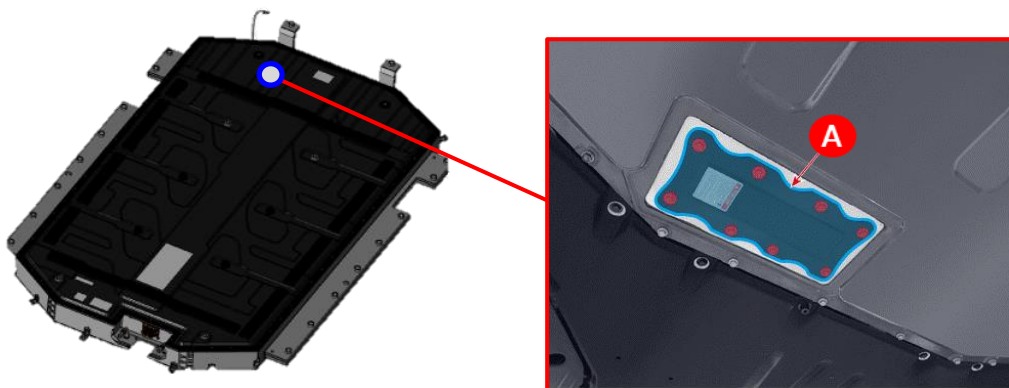

BMS ECU service cover (A)

8. Towing / Transportation / storage

8.3 Battery Storage

- To store the damaged battery safely, the battery must be discharged.
- If the battery can be removed from the vehicle, using salt water and discharge the battery.
- Prepare approx. 2% salt water by pouring salt into the water.
- Leave the battery in water for approx. 3 days
- Take out the battery from the container and dry it.

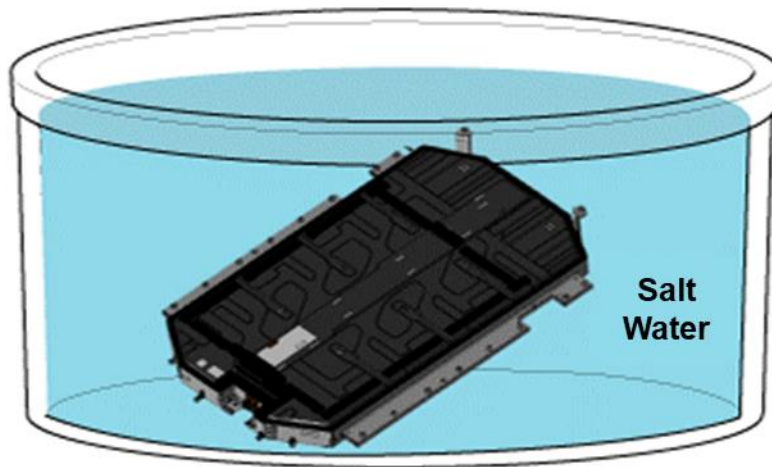

CAUTION

- Extinguish all smoke, spark, flame around the vehicle.
- Electrolyte solution is a skin irritant.
- Do not touch or step on the spilled electrolyte.
- If electrolyte leak occurs, wear appropriate solvent resistant PPE and use soil, sand or a dry cloth to clean up the spilled electrolyte. Be sure to adequately ventilate the area.

9. Important additional information

9.1 Emergency Starting

Jump Starting

Do not attempt to jump start the high voltage battery, as it cannot be jump started. In case of full discharge of the high voltage battery, the vehicle must be towed as mentioned on the previous page. In case the 12V auxiliary battery is discharged, refer the below procedure.

1. Make sure the booster battery is 12V and that its negative terminal is grounded.
2. If the booster battery is in another vehicle, do not allow the vehicles to come in contact.
3. Turn off all unnecessary electrical loads.

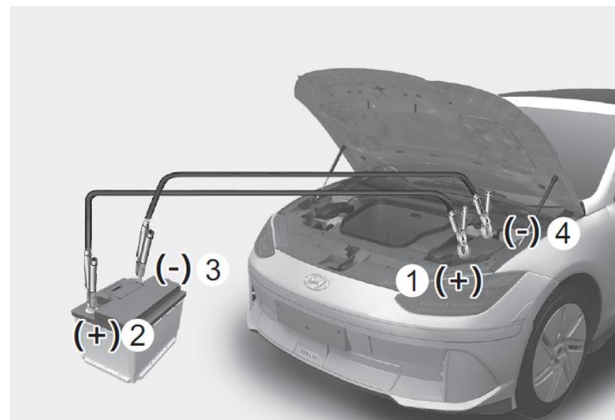
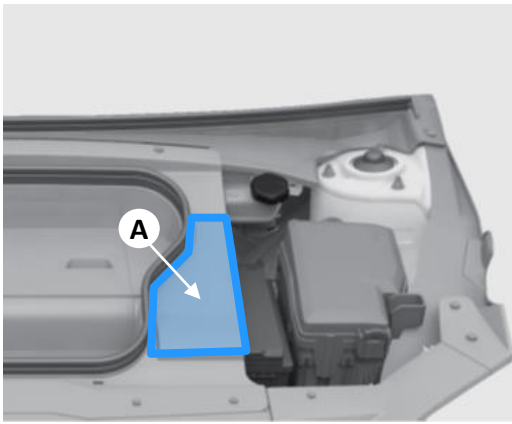

4. Open the hood and then remove the 12V battery cover (A) (refer the 8 page).
5. Connect the jumper cables in the exact sequence shown in the illustration.

First connect one end of a jumper cable to the positive terminal of the discharged battery (1), then connect the other end to the positive terminal on the booster battery (2).

Proceed to connect one end of the other jumper cable to the negative terminal of the booster battery (3), then the other end to a solid, stationary, metallic point away from the fuse box (4).

CAUTION

Do not attempt to jump start the IONIQ 6 high voltage battery.

Failure to follow these instructions will lead to serious bodily injury or death by electrical shock.

9. Important additional information

9.2 Airbag system (SRS: Supplemental Restraint System)

Airbag

Five airbags are installed in the IONIQ 6, located in the areas shown in the image below. Before performing any emergency procedure, make sure the vehicle ignition switch is turned off and disconnect the negative connector from the 12V auxiliary battery (located in the motor room) to prevent accidental deployment of undeployed airbags.

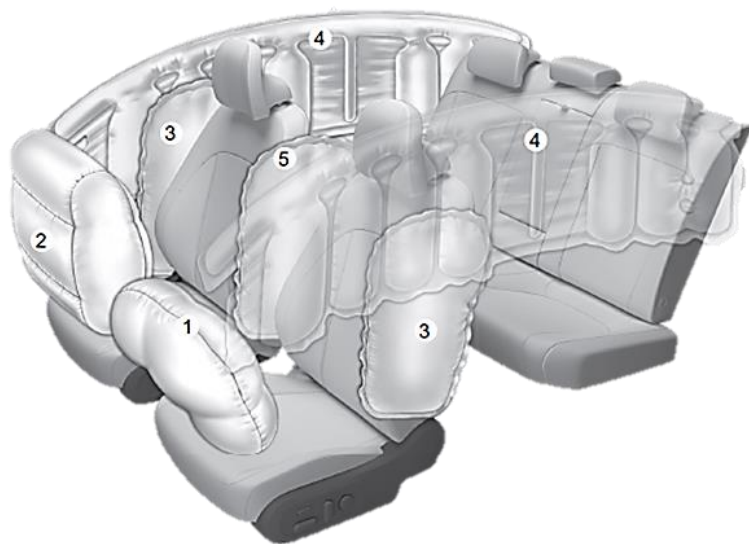

- (1) Driver front airbag
- (2) Passenger front airbag
- (3) Side airbag
- (4) Curtain airbag
- (5) Driver Center airbag

* The actual air bags and seats in the vehicle may differ from the illustration.

Seat Belt Pretensioner

In the IONIQ 6, the driver's and front passenger's seat belts are equipped with pretensioners. When the seat belt pretensioners are activated in a collision, a loud noise may be heard and fine dust, which may appear to be smoke, may be visible in the passenger compartment. These are normal operating conditions and are not hazardous. The seat belt pretensioner assembly mechanisms may become hot during activation and may need several minutes to cool down after they have been activated.

9. Important additional information

Airbag system components

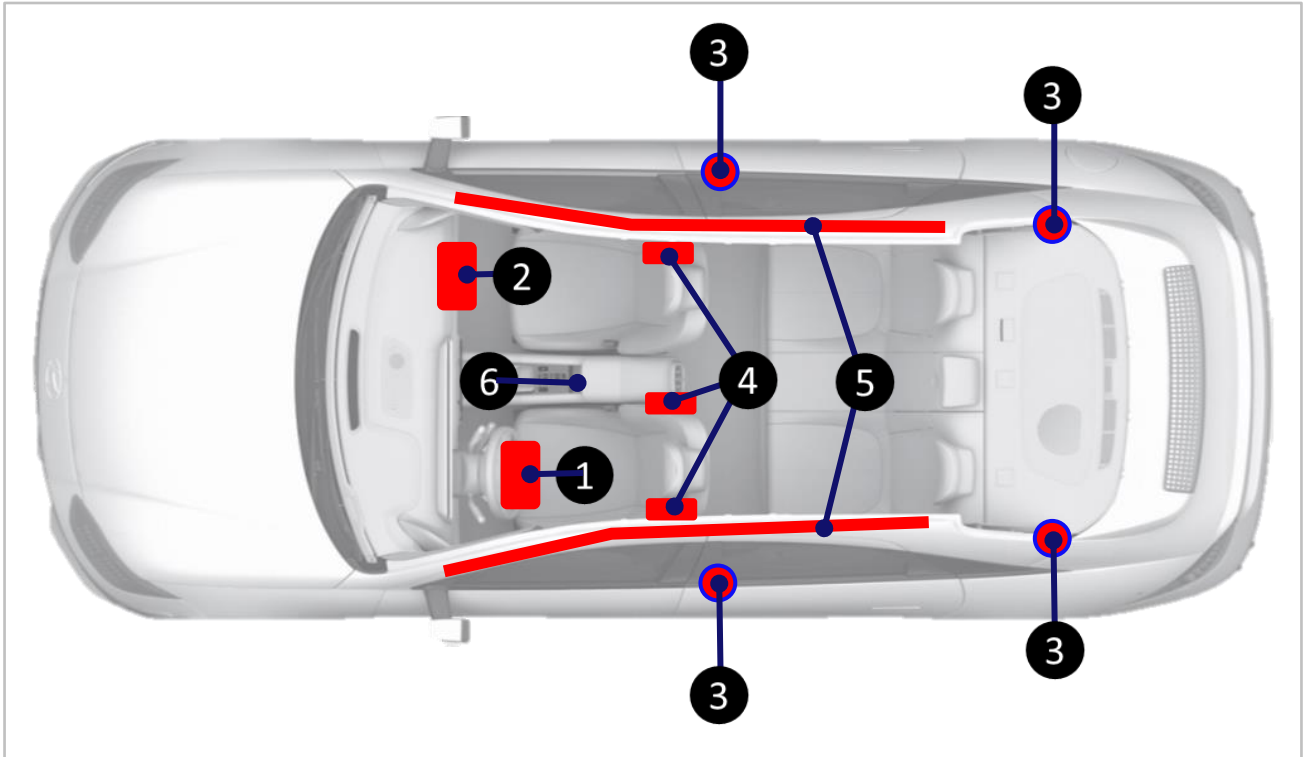

1. Driver's front Airbag (DAB)
2. Passenger's front Airbag (PAB)
3. Seat Belt Pretensioner (BPT)

4. Side Airbag (SAB)
5. Curtain Airbag (CAB)
6. Supplemental Restraint System Control Module (SRSCM)

CAUTION Undeployed Airbags

To avoid injuries caused by accidental deployment of undeployed airbags

- Do not cut the airbag system shown in the image above.
- Make sure the vehicle ignition switch is turned off, disconnect the negative cable from the 12V auxiliary battery (located in the motor room) and wait 3 minutes or longer to allow the system to deactivate.

Failure to follow any of these instructions may result in serious injury or death from accidental deployment of the airbag system.

9. Important additional information

Seat belt System



1) Front Seatbelt Pretensioner

2) Rear Seatbelt Pretensioner

CAUTION Undeployed Airbags

To avoid injuries caused by accidental deployment of undeployed airbags

- Do not cut the airbag system shown in the image above.
- Make sure the vehicle ignition switch is turned off, disconnect the negative cable from the 12V auxiliary battery (located in the motor room) and wait 3 minutes or longer to allow the system to deactivate.

Failure to follow any of these instructions may result in serious injury or death from accidental deployment of the airbag system.

Hyundai Motor Group Innovation Center in Singapore

(+65) 6335 3984

www.hyundai.com/sg

Komoco Motors Pte Ltd

(+65) 6475 8888

Copyright © 2024 Hyundai Motor Group

