

# i30 Sedan Hybrid.

## Emergency Response Guide.



## Hyundai Premium Roadside Support. 1800 186 306



### WARNING

- If severe damage causes high-voltage components to become exposed, emergency responders should take appropriate precautions and wear appropriate insulated personal protective equipment.
- Do not attempt to remove the safety plug while standing in the water.
- Never cut or disconnect the high-voltage orange cabling and connectors without first disabling the system by removing the safety plug.
- Exposed cables or wires may be visible inside or outside the vehicle. Never touch the wires, cables, connectors, or any electric components before disabling the system, to prevent injury or death due to electrical shock.

Failure to follow any of these instructions may result in serious injury or death by electrocution.

- Do not cut through any component of the Airbag (SRS) system (Supplementary Restraint System).
- SRS components may remain powered and active for up to 3 minutes after the 12V electrical system is shut off or disabled.

Disconnect the battery negative cable and wait for at least 3 minutes before beginning work.

Failure to follow any of these instructions may result in serious injury or death from accidental deployment of the airbag system.

# Contents.

<b>1. Identification/Recognition</b>	<b>3</b>
<b>2. Immobilisation/Stabilisation/Lifting</b>	<b>6</b>
<b>3. Disable direct hazards/Safety regulations</b>	<b>7</b>
<b>4. Access to the occupants</b>	<b>10</b>
<b>5. Stored energy/Liquid/Gases/Solids</b>	<b>13</b>
<b>6. In case of fire</b>	<b>16</b>
<b>7. In case of submersion</b>	<b>20</b>
<b>8. Towing/Transportation/Storage</b>	<b>21</b>
<b>9. Important additional information</b>	<b>24</b>

# 1. Identification/Recognition.

## **Initial response: Identify, Immobilise and Disable**

The following procedures should be used whenever you are dealing with a i30 Sedan HEV at an emergency scene. However, all operations should be consistent with your department's standard operating procedures, guidelines, and any applicable laws. When a HEV is damaged in a crash, the high-voltage safety systems may have been compromised and present a potential high-voltage electrical shock hazard. Exercise caution and wear appropriate personal protective equipment (PPE) safety gear, including high-voltage safety gloves and boots. Remove all metallic jewellery, including watches and rings.

## **Identify**

The i30 Sedan HEV is built on a conventional i30 Sedan chassis and therefore the appearance looks very similar to the internal combustion engine model.

Emergency responders should assume that any i30 Sedan you respond to is a Hybrid vehicle and respond to emergency scenarios involving the i30 Sedan HEV accordingly, exercising extreme care and caution to avoid contact with the high-voltage system within the vehicle.

# 1. Identification/Recognition.

## 1.1 Identifying a Hyundai i30 Sedan HEV

### Front and rear view of i30 Sedan HEV

The Hyundai i30 Sedan can be easily identified by the exterior design.



## Engine Compartment

The i30 Sedan HEV has a plastic cover with “Hybrid” clearly shown on it. Additionally, there are orange coloured high-voltage electrical cables in the motor compartment.



“HYBRID” on the cover



High-voltage cables

# 1. Identification/Recognition.

## 1.1 Identifying a Hyundai i30 Sedan HEV

### VIN Label

The VIN (Vehicle Identification Number) identifies a hybrid car with a “J” displayed in the 8th position, as shown in the below picture.

The VIN can be found:

1. VIN Plate can be seen through the windshield from outside.
2. On the vehicle certification label attached to the driver's side center pillar.
3. Underneath the front driver's seat.

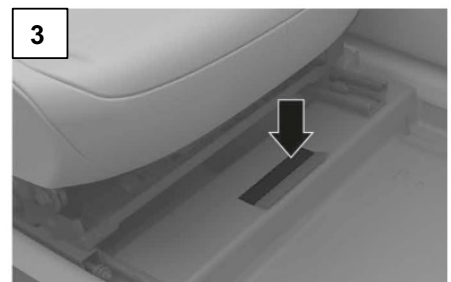
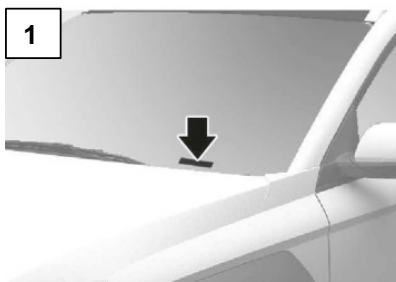
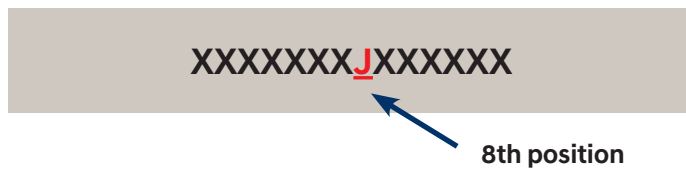

## 2. Immobilisation/Stabilisation/Lifting.

### 2.1 Immobilisation

The next step is to immobilise the vehicle to prevent any accidental movement that can endanger response personnel or civilians. When the i30 Sedan HEV is damaged in a crash, the vehicle may appear to be shut off when it is not due to no engine sounds.

When the “READY” mode light is illuminated on the instrument panel, the vehicle can move silently using the electric motor. Responders should approach the vehicle from the sides and stay away from the front or rear as they are potential paths for vehicle movement. Be sure to immobilise the vehicle in the following manner.



Put the vehicle in P (Park) position by pressing the ‘P’ button on the rotary shifter

Engage Parking Brake

Chock the Wheels

### 2.2 Vehicle stabilisation

Use standard stabilisation (lift) points, as shown below. Always be sure to connect to a structural member of the vehicle and avoid placing cribbing under high-voltage cables, and other areas not normally considered acceptable.

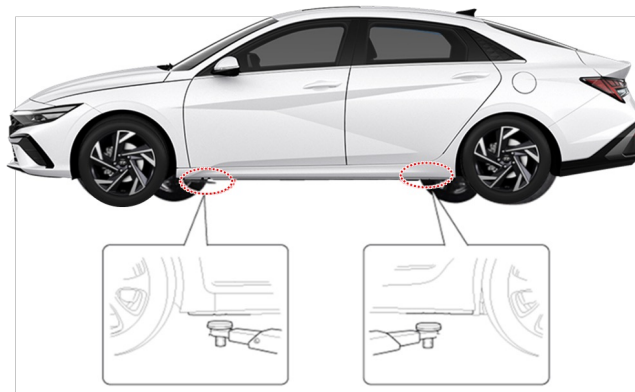

# 3. Disable direct hazards/Safety regulations.

The final step in the initial response process, conducted after immobilising the vehicle, is to disable the vehicle, its SRS components and the high-voltage electrical system. To prevent current flow through the system, use the following procedure to disable the vehicle.



## 3.1 Disabling the System

1. Confirm the status of the READY light on the instrument panel. If the  READY light is illuminated, the vehicle is ON.
  - a) If the READY light is NOT illuminated, the vehicle is off. Do not push the “POWER” START/STOP button because the vehicle may start (go into READY mode).
  - b) To turn OFF the system, position the shift lever in Park and press the POWER button.

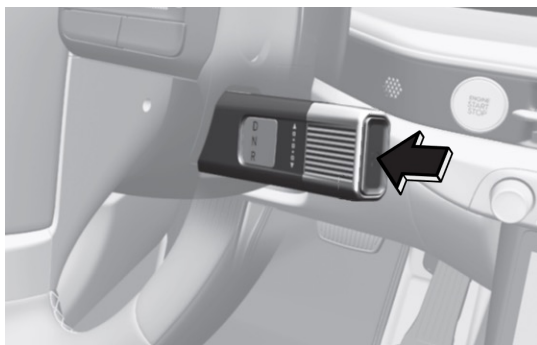

**Put the vehicle in P**



**“POWER” START/STOP button**

# 3. Disable direct hazards/Safety regulations.

## Without depressing the brake pedal

Pressing POWER button	Button Position/LED	Vehicle Condition
One time	ACC/ON	Electrical accessories are operational.
Two times	ON/ON	The warning lights can be checked before the vehicle is started.
Three times	OFF	Off

## While depressing the brake pedal

Pressing POWER button	Button Position/LED	Vehicle Condition
One time	START/OFF	Ready to drive

- If necessary, lower the windows, unlock the doors and open the tail gate as required, before disconnecting the 12V battery. Once the 12V battery is disconnected, power controls will not operate.
- Before disconnecting the 12V battery, remove the Smart Key at least 2 meters away from the vehicle to prevent accidental restart.

## 3.2 Disconnect the 12V auxiliary battery

Disconnect the 12V battery connector (A) located at the engine compartment.

a. Open the hood and locate the 12V connector

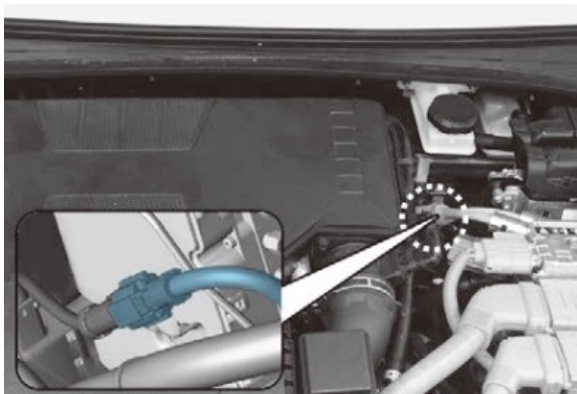

b. Disconnect the 12V battery connector (A)

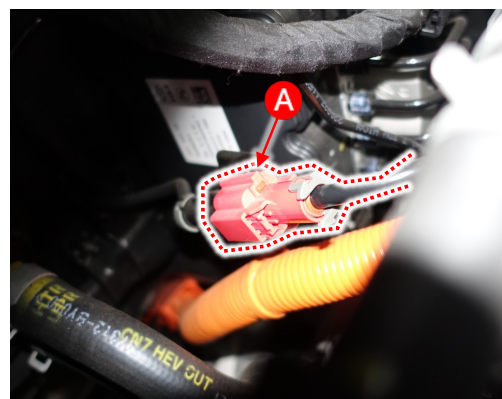



# 3. Disable direct hazards/Safety regulations.

## 3.3 Disconnect the high-voltage battery

In case of emergency, disconnect or cut the service interlock connector cable (A) to isolate the high-voltage of the battery.

- a. Remove the service interlock connector (A) located at the engine compartment.

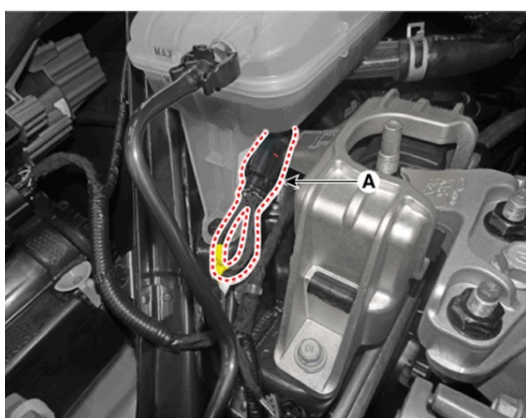

- b. If the Service Interlock connector cannot be disconnected, cut the wire attached the yellow warning label.

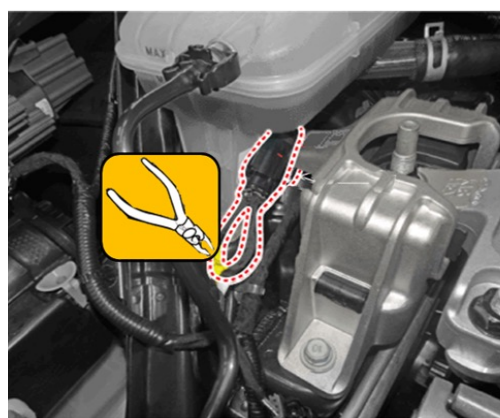

### WARNING

### Electrocution risk

- Before engaging in emergency response procedures, ensure the vehicle is disabled and wait for more than 5 minutes to allow the capacitor in the high-voltage system to discharge to avoid electrocution.
- Exposed cables or wires may be visible inside or outside the vehicle. To prevent injury or death due to electrical shock, never touch the wires or cables before disabling the system, to prevent injury or death due to electrical shock.

Failure to follow any of these instructions may result in serious injury or death by electrocution.

### WARNING

### Explosive risk

- SRS components may remain powered and active for up to 3 minutes after the 12V electrical system is shut off or disabled. Disconnect the battery cable and wait for at least 3 minutes before beginning work.

Failure to follow any of these instructions may result in serious injury or death from accidental deployment of the airbag system.

# 4. Access to the occupants.

## 4.1 Extraction operations

The i30 Sedan is a Hybrid model. Because of the high-voltage components contained therein, first responders should pay special attention when they extract occupants in the car. Before performing any extraction operations, the first responders should “Identify, Immobilise and Disable” the vehicle as discussed in sections on emergency procedures.

## 4.2 Vehicle stabilisation

Use standard stabilisation(lift) points, as shown below. Always be sure to connect to a structural member of the vehicle and avoid placing cribbing under high-voltage cables, and other areas not normally considered acceptable.

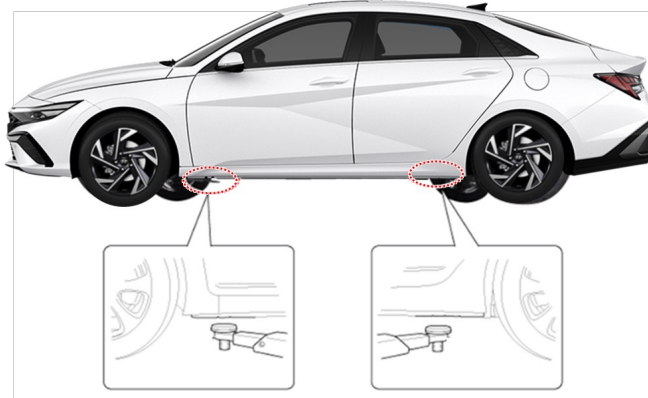

## 4.3 Extraction tools and procedure

When responding to an incident involving a i30 Sedan HEV, we recommend that the first responders follow their organisation’s standard operating procedures for dealing with vehicle emergencies.



When the first responders cut the vehicle, they should always pay special attention to the airbag system, orange coloured high-voltage cables and other high-voltage components so that the parts are not damaged and to prevent a risk of explosion.

# 4. Access to the occupants.

## 4.4 Location of ultra-high strength steel

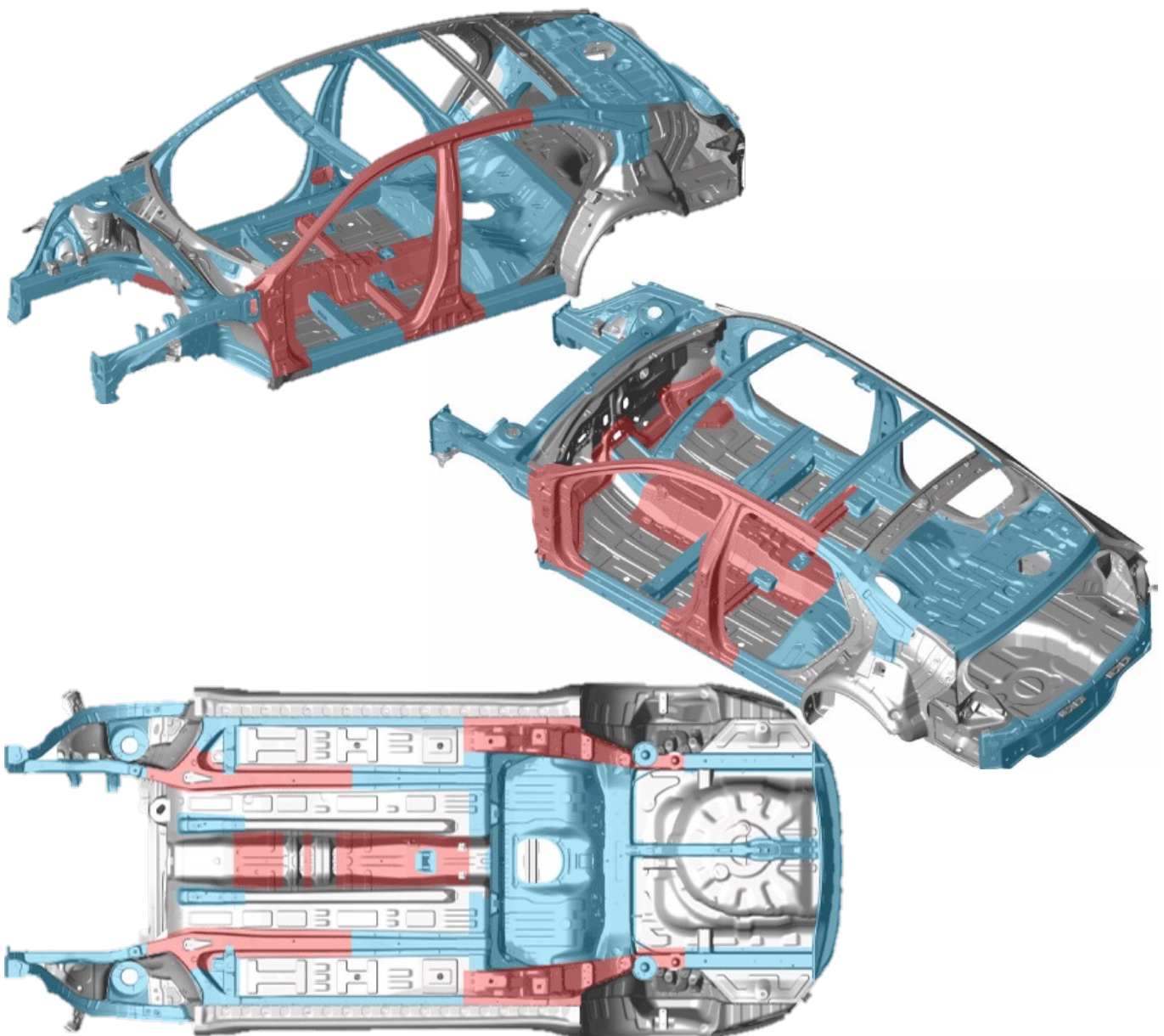
In these images, high strength steel is used in the areas colored in blue and ultra-high strength steel is used in the red colored areas. Depending on the tools used, ultra high strength steel can be challenging or impossible to cut. If necessary, use a workaround technique.











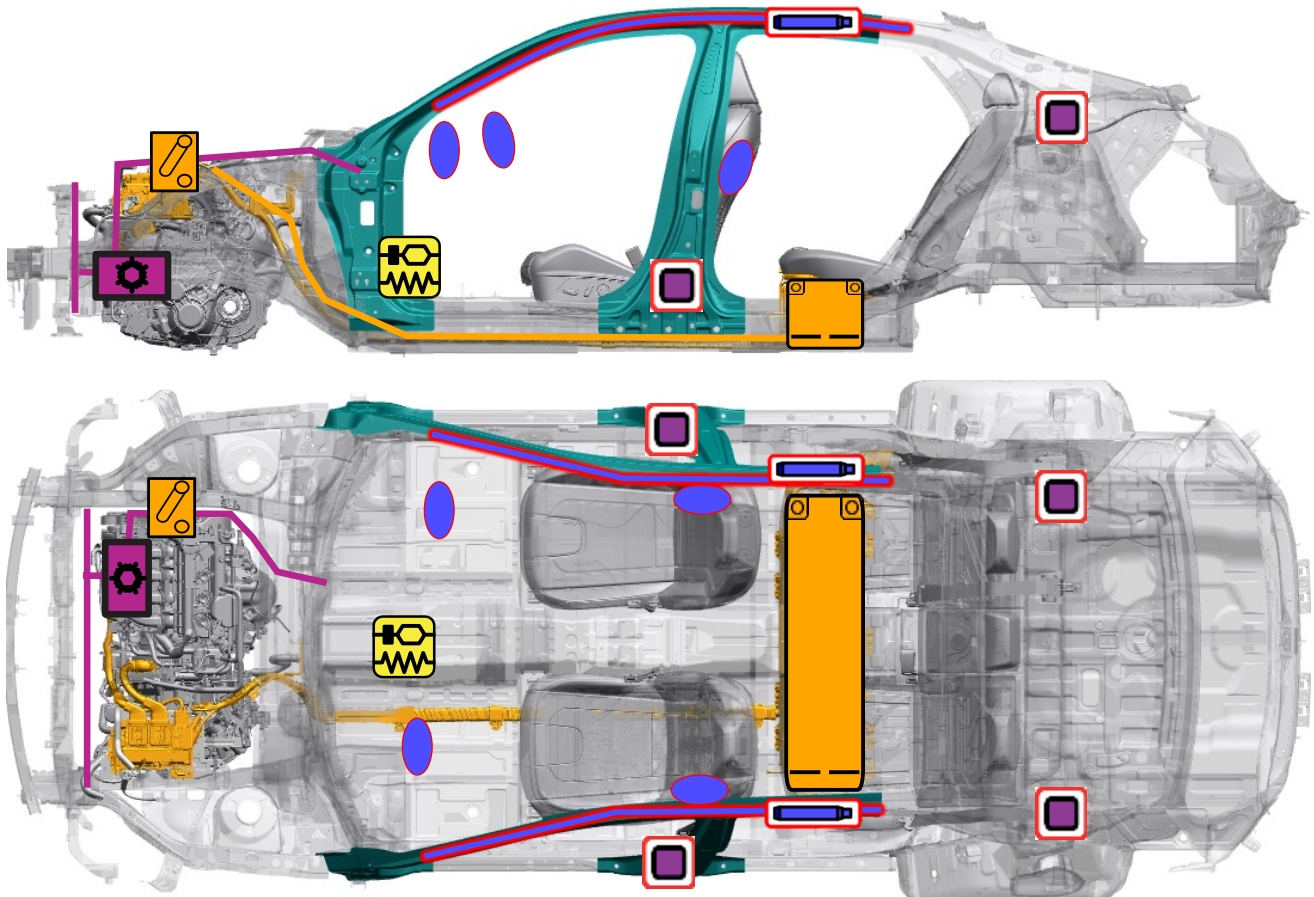



-  Mild steel
-  High strength steel
-  Ultra-high strength steel

# 4. Access to the occupants.

## 4.5 Occupants rescue guide

When dealing with an emergency situation, check the components as below.



	Supplemental Restraint System Control Module (SRSCM)		Airbag		Airbag Gas Inflators
	High-voltage cable		12V Battery		Air-conditioning line
	High-voltage disconnect		OBC (On – Board Charger)		Ultra-High Strength Steel
	High-voltage Battery		Air-conditioning component		Seat belt pretensioner

# 5. Stored energy/Liquid/Gases/Solids.

## 5.1 High-voltage system

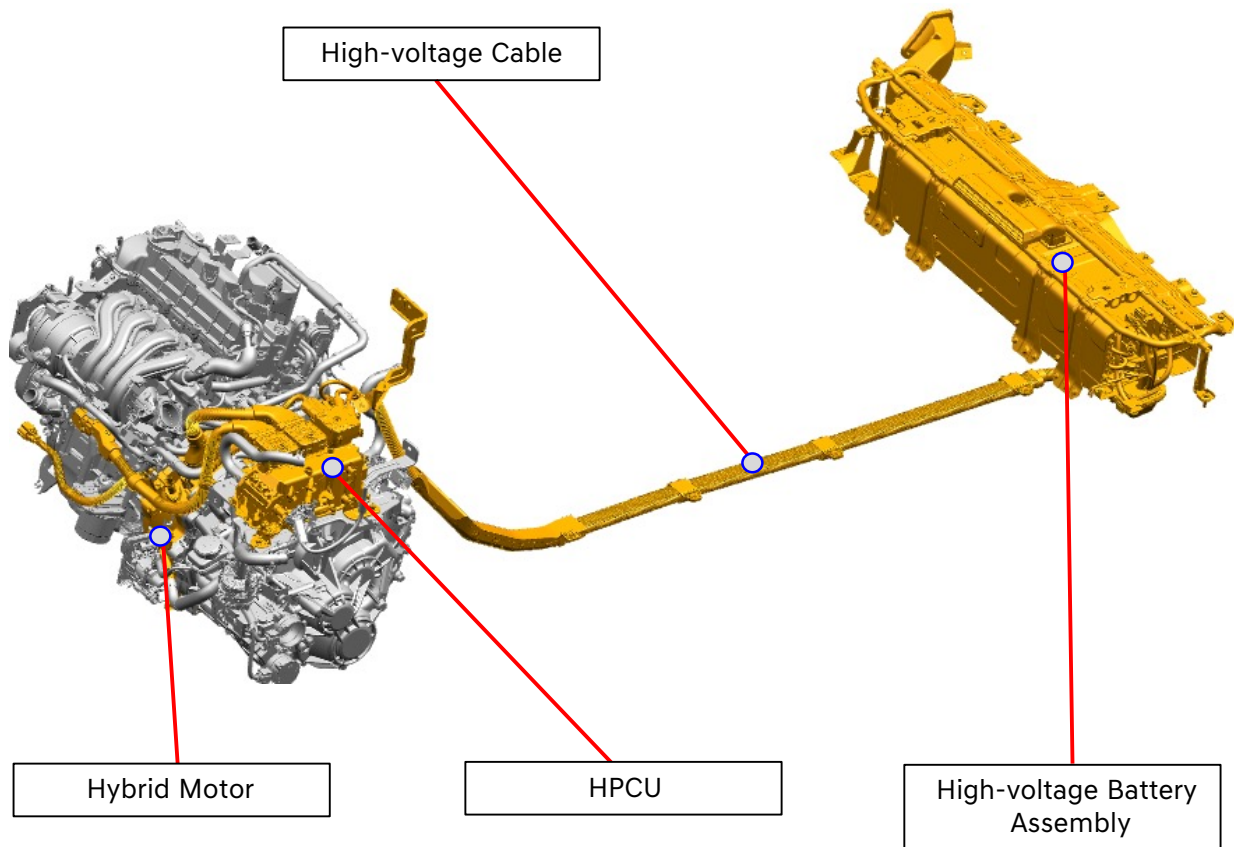

<b>HPCU</b>	Supplies electric energy to traction motor and stores generated electric energy.
<b>Motor</b>	When current flows through the coil. It generates a rotating magnetic field and generates motor torque.
<b>H.V. Battery</b>	Supplies electric energy to traction motor and stores generated electric energy.
<b>H.V. Cable</b>	The high-voltage cabling is orange per the SAE standard.

### CAUTION

- There is the capacitor inside the HPCU. Wait 5+ minutes for the capacitor to discharge after disabling the vehicle.

# 5. Stored energy/Liquid/Gases/Solids.

## 5.1 High-voltage system

### High-voltage battery

The HV lithium-ion polymer battery supplies and stores electric energy, to the traction motor, and is located under the i30 Sedan HEV chassis.

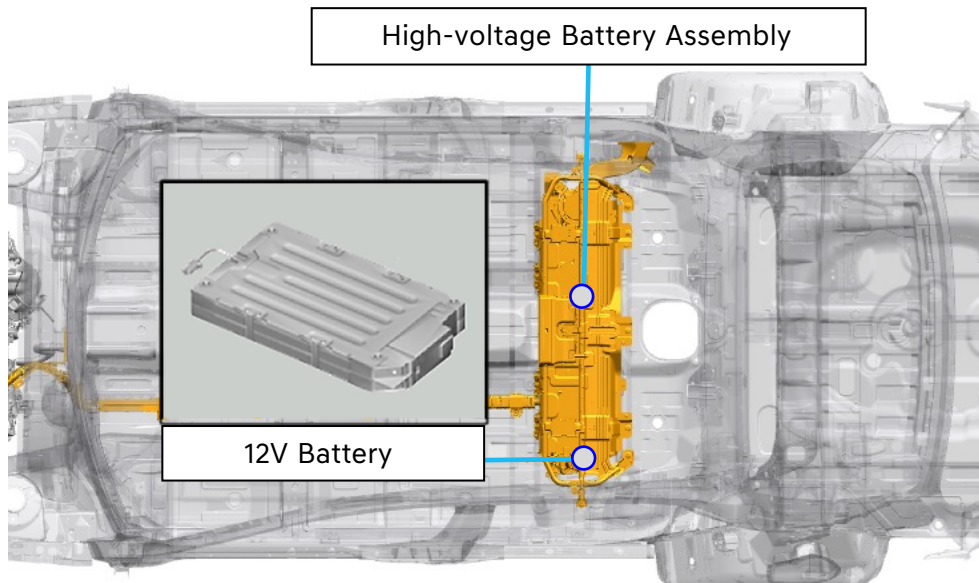

### Specification

<b>Motor</b>	Type	Permanent Magnet Synchronous Motor
	Max. Output (kW)	32
	Max Torque (Nm)	170
<b>High-voltage Battery</b>	Rated Voltage (V)	240
	Energy (kWh)	1320
	Quantity for Pack (Cell/Module)	64 cells/8 modules

# 5. Stored energy/Liquid/Gases/Solids.

## 5.2 High-voltage orange cabling

The high-voltage cabling is orange, per Society of Automotive Engineers (SAE) standards. Cables run under the floor of the vehicle and connect the high-voltage battery to the HPCU, Motor, LDC, Inverter, A/C compressor and other high-voltage components located towards the front of the vehicle.

The presence of orange cables under the hood, in the under-floor battery compartment, or HV cables under the car, identifies the vehicle as an electric vehicle.

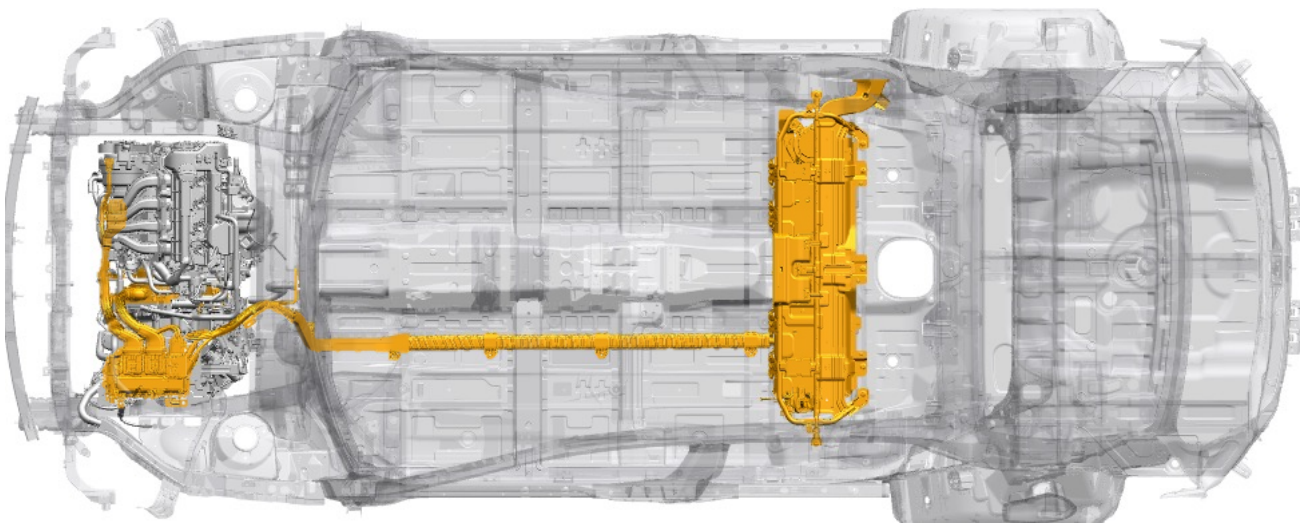

### CAUTION

- Never cut or disconnect the high-voltage orange cabling and connectors without first disabling the HV system (refer to page 7).
- Exposed cables or wires may be visible inside or outside the vehicle. Never touch the metal chassis wires, cables, connectors, or any electric components before disabling the system, and; or shorted to the vehicle chassis.

Failure to follow these instructions will lead to serious bodily injury or death by electrical shock.

# 6. In case of fire.

## 6.1 Firefighting operations

Strict precautions must be taken while conducting firefighting operations due to following reasons:

- Lithium-ion batteries contain electrolytes that can vent, ignite, and produce sparks when subjected to temperatures above 150°C.
- Vehicle may burn rapidly with a flare-burning effect.
- Even after the high-voltage battery fire appears to have been extinguished, renewed or delayed fire can occur.
  - Use a thermal imaging camera to ensure the high-voltage battery is completely cooled before leaving the incident.
  - Always advise second responders that there is a risk of the battery re-igniting.
  - In a fire, submersion or a collision that has compromised the high-voltage battery, always store it in an open area with no exposures within 50 feet.
- A burning battery could release hydrogen fluoride, carbon monoxide, and carbon dioxide gasses. Use NIOSH/MSHA approved full-face self-contained breathing apparatus (SCBA) with full protective gear. Even if the high-voltage battery pack is not directly involved in a vehicle fire, approach the vehicle very carefully.

## 6.2 Extinguishers

- Small fires that do not involve the high-voltage battery should be extinguished using an ABC fire extinguisher (ex. Fire caused by wiring harnesses, electrical components etc.).
- Do not attempt to extinguish fires that involve the high-voltage battery with small amounts of water as this can result in electrocution. Fires that involve the high-voltage battery should be extinguished using large amounts of water (max 10,000 litres) to cool the high-voltage battery. Firefighters should not hesitate to pour larger amounts of water on the vehicle in such scenarios. Make sure the battery is fully cooled to avoid fire re-ignition.



# 6. In case of fire.

## 6.3 How to deal with the situation

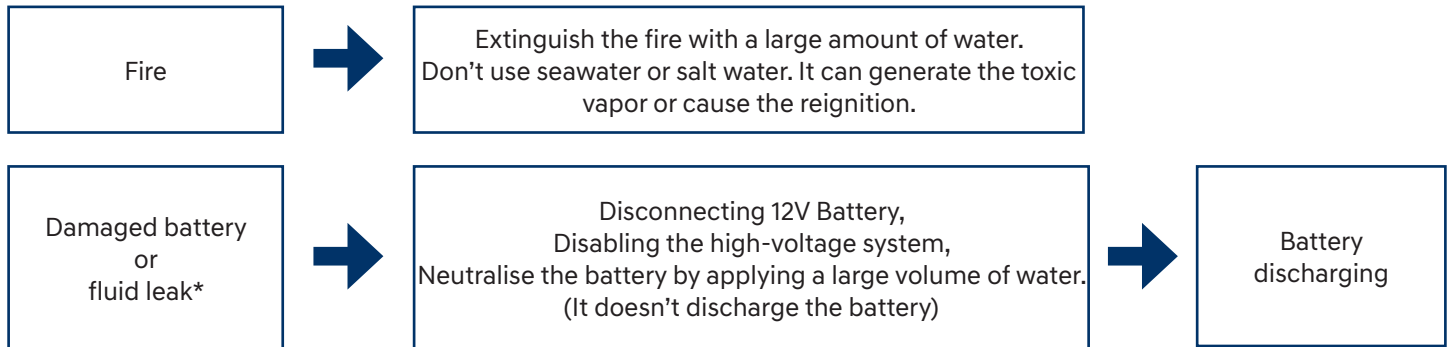

\*If electrolyte solution leakage, or any damage to the H.V battery casing is observed

### 6.3.1 Vehicle fire

- Use a large volume of water (max.10,000 litres). The water must cool down the battery.
- If water is put into the high-voltage battery casing, it will be better to cool down the battery (but never attempt to penetrate the HV battery or its casing to apply water).



- Soaking the vehicle in the container filled with water can be an effective way to extinguish the fire.

# 6. In case of fire.

## 6.3.2 High-voltage battery damage and fluid leaks

If electrolyte solution leakage, or any damage to the lithium-ion battery casing is observed, the first responders should attempt to neutralize the battery by applying a large volume of water to the battery pack while wearing appropriate Personal Protective Equipment (PPE). The neutralization process helps stabilize the thermal condition of the battery pack but does not discharge the battery.

- Do not put any smoke, spark, flame around the vehicle.
- Do not touch or step on the spilled electrolyte.
- If electrolyte leak occurs, wear appropriate solvent resistant PPE and use soil, sand, or a dry cloth to clean up the spilled electrolyte. Be sure to adequately ventilate the area.

### CAUTION

### Electrolyte irritation

The high-voltage battery contains electrolyte solution. To avoid exposure to electrolyte solution and serious personal injury, always wear appropriate solvent resistant PPE (Personal Protective Equipment) and SCBA (Self-Contained Breathing Apparatus).

- Electrolyte solution is an eye irritant. In the event of contact with eyes, rinse with plenty of water for 15 minutes.
- Electrolyte solution is a skin irritant. Therefore, in the event of contact with skin, wash off with a soap.
- Electrolyte liquid or fumes coming into contact with water will create vapours in the air from oxidization. These vapours may irritate skin and eyes. In the event of contact with vapours, rinse with plenty of water and consult a doctor immediately.
- Electrolyte fumes (when inhaled) can cause respiratory irritation and acute intoxication. Inhale fresh air and wash mouth with water. Consult a doctor immediately.

# 6. In case of fire.

## 6.4 High-voltage battery re-ignition by stranded energy

Damaged cells in the high-voltage battery can experience thermal runaway\* and reignition.

To prevent reignition, the first responder and second responder need to be aware of the risk of stranded energy\* which remains in the damaged cells and lead to reignition.

\* Thermal runaway: The originating cause of thermal runaway is generally short-circuiting inside a battery cell and a resulting increase in the cell's internal temperature. Battery produces heat with thermal runaway and it can spread from one battery cell to many cells, in a domino effect.

\* Stranded energy: Energy remains inside any undamaged battery cells after the accident. That stranded energy can cause a high-voltage battery to reignite multiple times after firefighters a fire.

### How to prevent reignition (Mitigating stranded energy risk)

Use a thermal imaging camera to ensure the high-voltage battery is completely cooled before leaving the incident. Always advise second responders that there is a risk of the battery re-igniting.

1. 12V battery terminal disconnection (to depower battery management system)
2. High-voltage shut off (refer to pages 7-9)
3. Discharging the high-voltage battery (refer to pages 22-23)

# 7. In case of submersion.

## 7.1 Submerged or partially submerged vehicles

Some emergency responses can involve a submerged vehicle. A i30 Sedan HEV that is submerged does not have high-voltage components on the vehicle's body or framework. It is safe to touch the vehicle's body or framework if there is no severe damage to the vehicle, whether it is in water or on land.

In the event of the vehicle is submerged or partially submerged, remove the vehicle from the water before attempting to disable the vehicle. Drain the water from the vehicle. Use one of the methods described in page 7-9 to disable the vehicle. Then, discharge the battery by referring to pages 22-23.

### CAUTION

- If severe damage causes high-voltage components to become exposed, responders should take appropriate precautions and wear appropriate insulated personal protective equipment.

Failure to follow these instructions can lead to death or serious injury by electrocution.

# 8. Towing/Transportation/Storage.

## 8.1 Towing and transportation

In the event of an accident, the high-voltage system must be disabled. The safety plug must be removed from the high-voltage battery according to one of the methods described in page 7-9 to disable the vehicle.

Towing the i30 Sedan HEV Vehicle is not different from towing a conventional electric vehicle.

If emergency towing is necessary, we recommend having it done by an authorised Hyundai dealer or a commercial tow-truck service. Proper lifting and towing procedures are necessary to prevent damage to the vehicle.

The use of wheel dollies or flatbed is recommended.

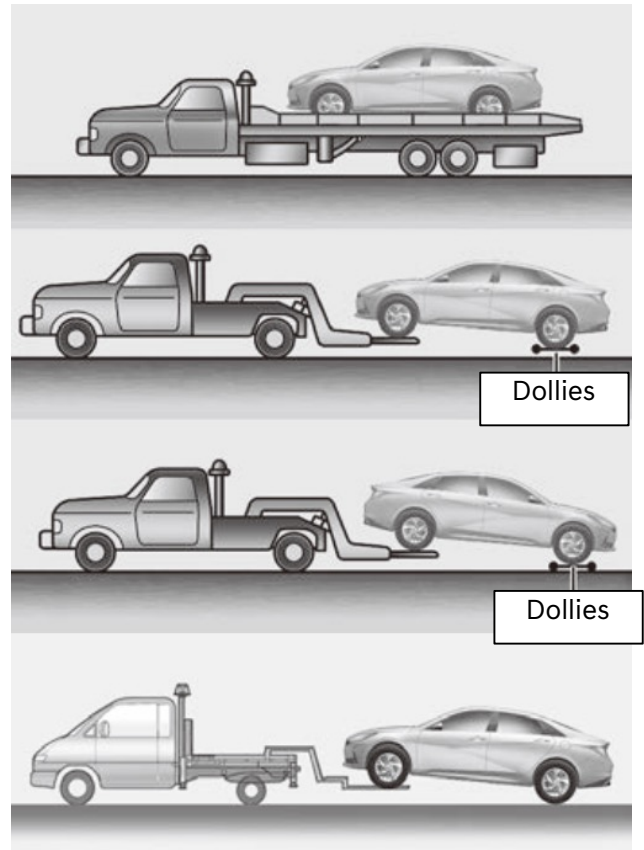

### CAUTION

- Do not tow with sling-type equipment. Use wheel lift or flatbed equipment.
- Never tow the vehicle with the front wheels on the ground (forward or backward), as this may cause fire or damage to the motor.

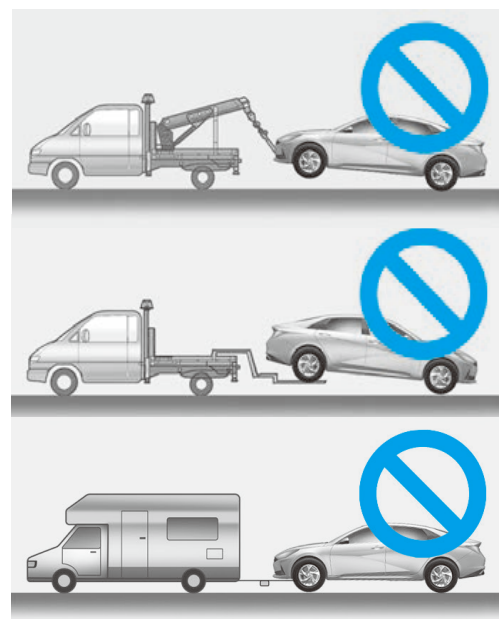

# 8. Towing/Transportation/Storage.

## 8.2 Storage of damaged vehicle with the damaged battery

- Drain fluids and water, then disconnect the 12V battery connector and interlock connector before storing a damaged vehicle.
- Place the vehicle in an open space away from any structure, vehicle, or building.
- Then, monitor the vehicle until the discharging procedures are completed.
- If the battery can be removed from the vehicle by moving the vehicle on the lift, remove and discharge the battery.
- If the battery can't be removed, place the vehicle into a sufficiently large container and add enough water until the entire battery is submerged.
- Add enough salt to the water container to create a 2% saltwater solution.
- Leave the battery submerged in the saltwater solution for 3 days.
- Then, drain the water and dry the battery.
- If the high-voltage battery cannot be removed or the vehicle cannot be flooded, store the vehicle with waterproof cover.

Waterproof cover: size/material that can prevent water from entering the battery.



**Battery discharging**

# 8. Towing/Transportation/Storage.

## 8.3 Battery storage

- To store the damaged battery safely, the battery must be discharged.
- If the battery can be removed from the vehicle, discharge the battery to prevent re-ignition.
- Place the battery into a sufficiently large container and add water until the battery is completely submerged.
- Add enough salt to the water container to create a 2% saltwater solution.
- Leave the battery submerged in the saltwater solution for 3 days.
- Remove the battery from the saltwater solution and dry it.

### CAUTION

- Extinguish all smoke, spark, flame around the vehicle.
- Electrolyte solution is a skin irritant.
- Do not touch or step on the spilled electrolyte.
- If electrolyte leak occurs, wear appropriate solvent resistant PPE and use soil, sand, or a dry cloth to clean up the spilled electrolyte. Be sure to adequately ventilate the area.

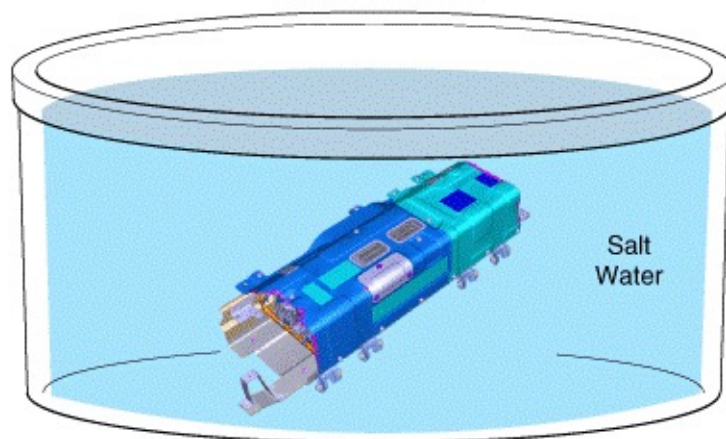

# 9. Important additional information.

## 9.1 Emergency starting

### Jump starting

1. Make sure the booster battery is 12V and that its negative terminal is grounded.
2. If the booster battery is in another vehicle, do not allow the vehicles to come in contact.
3. Turn off all unnecessary electrical loads.

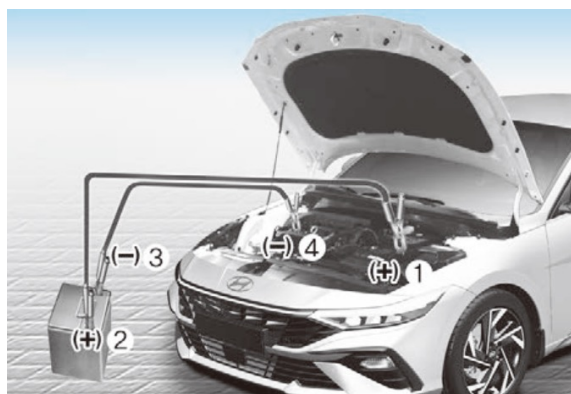
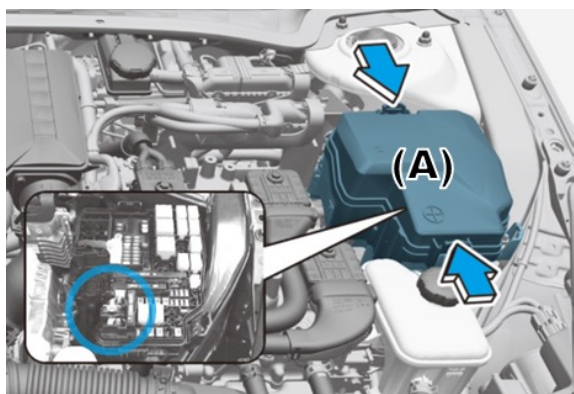

4. Open the hood and then remove the fuse cover (A).
5. Follow the procedure below to connect the jumper cables: Connect the jumper cable to the discharged battery (+) terminal (1), then connect the other end to the positive terminal of the booster battery or assisting vehicle (2). Connect one end of the other jumper cable to the booster battery (-) terminal (3), then the other end to a solid, stationary, metallic point away from the fuse box (4).
6. Start the engine of the assisting vehicle and let it run for a few minutes.
7. Press the 12V BATT RESET button and then start your vehicle as soon as possible.

If the cause of your battery discharging is not apparent, we recommend that the system be checked.

### CAUTION

- Do not attempt to jump start the high-voltage battery.
- Do not jump start another vehicle with hybrid vehicle. Jump starting another vehicle will damage the hybrid vehicle's 12V battery (Lithium Polymer type).



# 9. Important additional information.

## 9.2 Airbag system (SRS: Supplemental Restraint System)

### Airbag

Six airbags are installed in the i30 Sedan HEV, located in the areas shown in the image below. Before performing any emergency procedure, make sure the vehicle ignition switch is turned off and disconnect the 12V auxiliary battery to prevent accidental deployment of undeployed airbags.

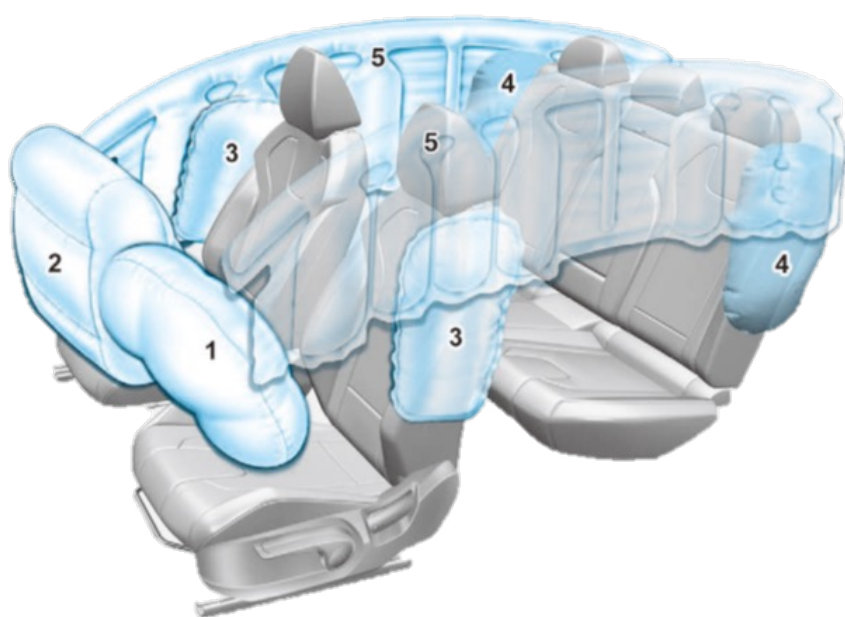

- (1) Driver front airbag
- (2) Passenger front airbag
- (3) Front Side airbag
- (4) Rear Side airbag
- (5) Curtain airbag

The actual air bags and seats in the vehicle may differ from the illustration.

### Seat Belt Pretensioner

In the i30 Sedan HEV, the driver's and front passenger's seat belts are equipped with pretensioners. When the seat belt pretensioners are activated in a collision, a loud noise may be heard and fine dust, which may appear to be smoke, may be visible in the passenger compartment. These are normal operating conditions and are not hazardous. The seat belt pretensioner assembly mechanisms may become hot during activation and may need several minutes to cool down after they have been activated.

# 9. Important additional information.

## Airbag system components

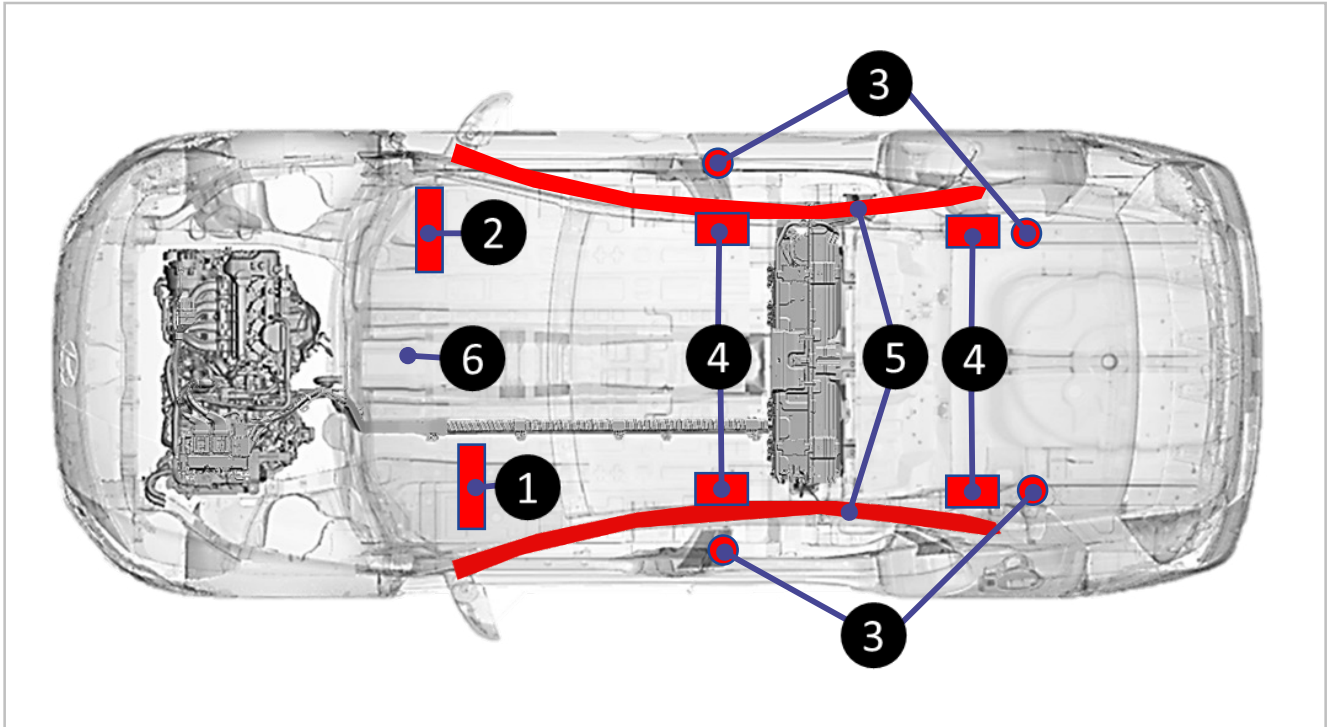

- |                             |   |
|-----------------------------|---|
| 1. Driver's front airbag    | 5. Curtain Airbag                                       |
| 2. Passenger's front airbag | 6. Supplemental Restraint System Control Module (SRSCM) |
| 3. Seat Belt Pretensioner   |   |
| 4. Side Airbag              |   |

### CAUTION

### Undeployed airbags

To avoid injuries caused by accidental deployment of undeployed airbags:

- Do not cut the airbag system shown in the image above.
- Make sure the vehicle ignition switch is turned off, disconnect the 12V auxiliary battery and wait 3 minutes or longer to allow the system to deactivate.

Failure to follow any of these instructions may result in serious injury or death from accidental deployment of the airbag system.

# 9. Important additional information.

## Seat belt system

1) Front Seatbelt Pretensioner

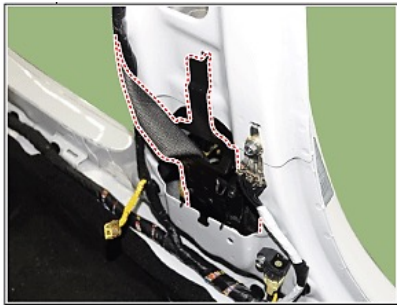

2) Rear Seatbelt Pretensioner

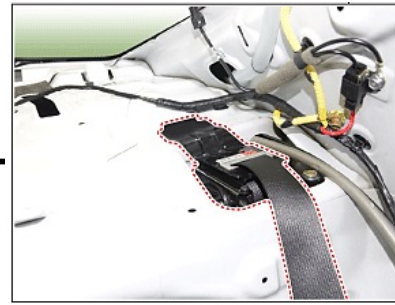

### CAUTION

### Undeployed airbags

To avoid injuries caused by accidental deployment of undeployed airbags:

- Do not cut the airbag system shown in the image above.
- Make sure the vehicle ignition switch is turned off, disconnect the 12V auxiliary battery and wait 3 minutes or longer to allow the system to deactivate.

Failure to follow any of these instructions may result in serious injury or death from accidental deployment of the airbag system.

# Hyundai Premium Roadside Support.

## 1800 186 306

**Hyundai Motor Company Australia**  
394 Lane Cove Road, Macquarie Park, NSW Australia 2113.  
[hyundai.com/au/en](http://hyundai.com/au/en)

Hyundai Motor Company (HMC) and Hyundai Motor Company Australia (HMCA) each reserve the right to alter vehicle specifications and equipment levels without notice. Some equipment featured on the cars in this brochure may not be available in Australia or may be optional. To the extent permitted by law, neither HMC nor HMCA shall be liable to any person as a result of reliance on the content of this brochure. Please consult your Hyundai Dealer for the latest specifications, equipment levels, options, prices, colours and vehicle availability. Images in the brochure may include option packs or accessories available at an additional cost. Metallic and mica paint are optional extras. Note: Information in this Emergency Response Guide is current as at 02/2024.