

INSTER.

Emergency Response Guide.



Hyundai Premium Roadside Support.
1800 186 306



WARNING

- If severe damage causes high-voltage components to become exposed, emergency responders should take appropriate precautions and wear appropriate insulated personal protective equipment.
- Do not attempt to remove the safety plug while standing in the water.
- Never cut or disconnect the high voltage orange cabling and connectors without first disabling the system by removing the safety plug.
- Exposed cables or wires may be visible inside or outside the vehicle. Never touch the wires, cables, connectors, or any electric components before disabling the system, to prevent injury or death due to electrical shock.

Failure to follow any of these instructions may result in serious injury or death by electrocution.

- Do not cut through any component of the Airbag (SRS) system (Supplementary Restraint System).
- SRS components may remain powered and active for up to 3 minutes after the 12V electrical system is shut off or disabled.

Disconnect the battery negative cable and wait for at least 3 minutes before beginning work.

Failure to follow any of these instructions may result in serious injury or death from accidental deployment of the airbag system.

Introduction.

The ERG (Emergency Response Guide) provided by Hyundai describes emergency response operations, warnings, and precautions related to the vehicle. This publication is intended to provide necessary information for vehicle accident rescue operations and for the training and further education of first and second responders.

Please note that the guide may be updated by Hyundai on an ongoing basis. It is not intended for retailers, end consumers, or any other readers not mentioned in the preceding sentence.

The provided guide applies only to the Hyundai INSTER vehicle and includes information about the location and description of high-voltage components and the vehicle's structure. However, it does not cover every scenario in emergency situations. Failure to follow the recommended procedures during emergency response may result in death or other serious injuries. It is important to read the guide in advance as it contains necessary information about the vehicle's features and other provided content in the event of an accident.

IMPORTANT INFORMATION



WARNING

A WARNING indicates a situation in which harm, serious bodily injury or death could result if the warning is ignored.



Contents.

1. Identification/Recognition	4
2. Immobilisation/Stabilisation/Lifting	7
3. Disable direct hazards/Safety regulations	8
4. Access to the occupants	11
5. Stored energy/Liquid/Gases/Solids	14
6. In case of fire	17
7. In case of submersion	19
8. Towing/Transportation/Storage	20
9. Important additional information	22
10. Explanation of pictograms used	24



WARNING

Failure to follow any of these instructions may result in serious injury, death or damage.



1. Identification/Recognition.

Initial response: Identify, Immobilise and Disable

The following procedures should be used whenever you are dealing with an INSTER at an emergency scene. However, all operations should be consistent with your department's standard operating procedures, guidelines, and any applicable laws. When an INSTER is damaged in a crash, the high voltage safety systems may have been compromised and present a potential high voltage electrical shock hazard. Exercise caution and wear appropriate personal protective equipment (PPE), including high voltage safety gloves and boots. Remove all metallic jewellery, including watches and rings.

	Items	mm
l	Overall length	3825
w	Overall width	1610
h	Overall height	1575

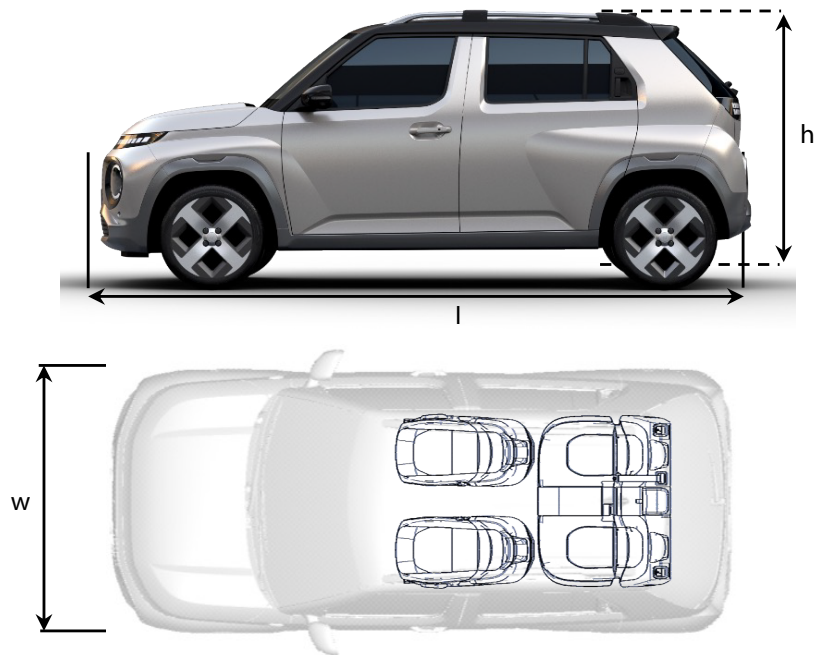

Identify

The INSTER is an electric vehicle. Emergency responders should respond to emergency scenarios involving the INSTER accordingly, exercising extreme care and caution to avoid contact with the high voltage system within the vehicle.

1. Identification/Recognition.

Identifying a Hyundai INSTER

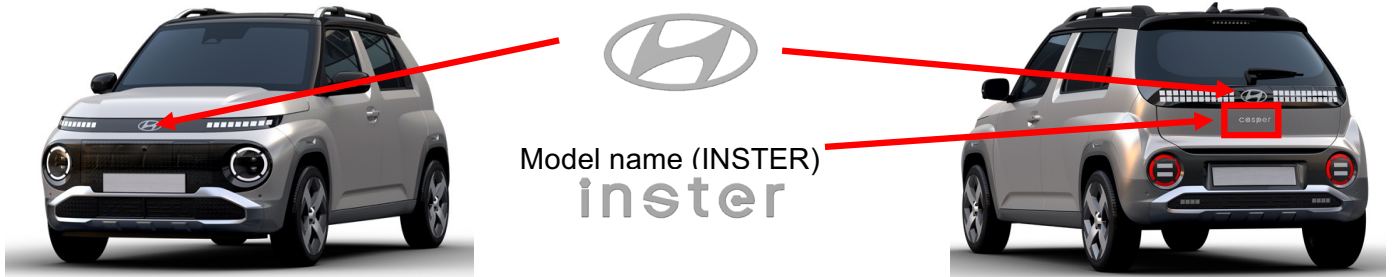

Front and rear view of Hyundai INSTER

The Brand Logo placed on the Front and Rear Center LAMP.

Model name on Tailgate “INSTER”

The model name “INSTER” is placed in the middle of the tailgate.

Charging Port

The charging port is located on the left side in the front.

Note that the doors must be unlocked to open the charge port door.

How to open the charging port

1. Press the unlock door button, depress the brake pedal and apply the Electric Parking Brake (EPB).
2. Turn OFF all switches, move the shift lever to P (Park) and turn off the vehicle.
3. Open the charging door by pressing the A of the charging port.
4. Pull the charging door cover fully open towards the front of the vehicle.

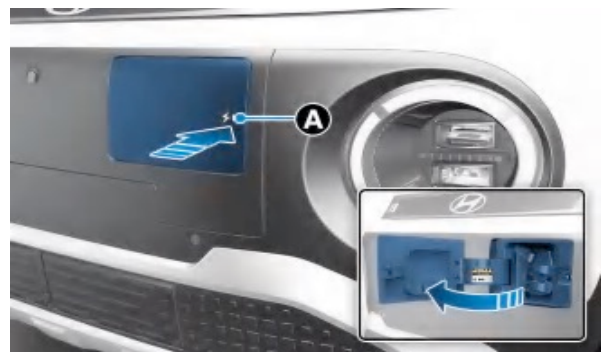

1. Identification/Recognition.

Vehicle Identification Number (VIN) Label

The VIN Number is specified in the INSTER and identifies the single variants as below.

Location of VIN in the INSTER

Underneath the front passenger seat (or driver seat).



Instrument Cluster

The INSTER instrument cluster displays EV specific features such as high voltage battery SOC (State of Charge) as below.



- | | |
|--|---|
| 1. Speedometer | 6. Outside temperature gauge |
| 2. Warning and indicator lights | 7. Reduction gear shift indicator |
| 3. Power/Charge gauge | 8. Cluster display |
| 4. Distance to empty | 9. Regenerative braking level indicator |
| 5. Battery SOC (State of Charge) gauge | 10. Odometer |

2. Immobilisation/Stabilisation/Lifting.

Immobilisation

The next step is to immobilise the vehicle to prevent any accidental movement that can endanger response personnel or civilians. Responders should approach the vehicle from the sides and stay away from the front or rear as they are potential paths for vehicle movement. Be sure to immobilise the vehicle in the following manner.



Chock the wheels

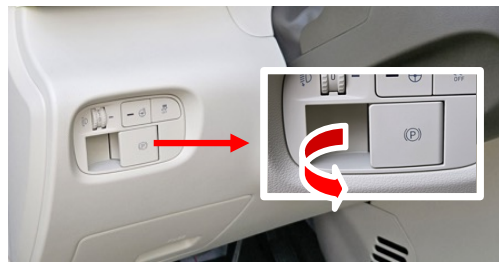

Set the Electronic Parking Brake (EPB)



Put the vehicle in P (Park) position by pressing the 'P' button on the rotary shifter

Stabilisation

Use standard stabilisation (lift) points, as shown beside. Always be sure to connect to a structural component of the vehicle and avoid placing cribbing under high voltage cables, and other areas not normally considered acceptable.

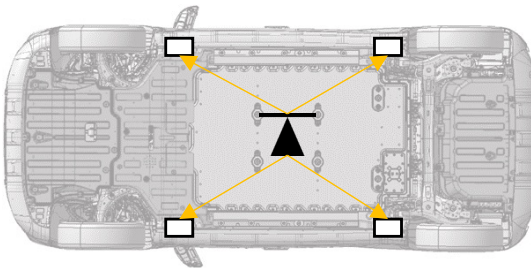

Lifting

- When installing a block or jack, avoid high voltage cable, battery and fuel system.
- If high voltage components or cables are exposed, do not place any support on them.

3. Disable direct hazards/Safety regulations.

The final step in the initial response process, conducted after immobilising the vehicle, is to disable the vehicle, its SRS components and the high voltage electrical system. To prevent current flow through the system, use one of the following procedures to disable the vehicle.

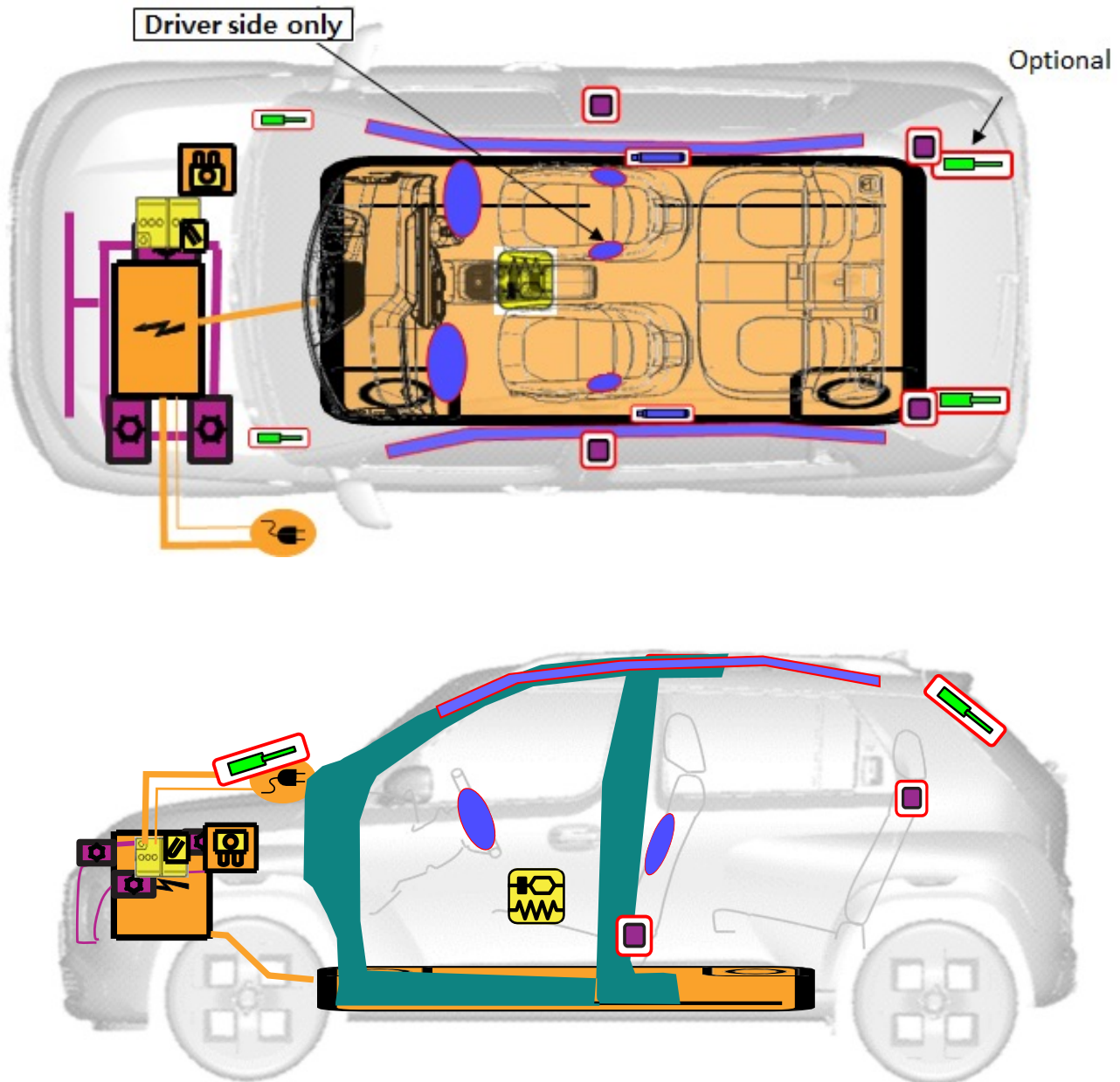

High Voltage Cables

- Never cut or disconnect the high voltage orange cabling and connectors without first disabling the HV system. (refer to page 10).
- Exposed cables or wires may be visible inside or outside the vehicle. Never touch the metal chassis wires, cables, connectors, or any electric components before disabling the system.

3. Disable direct hazards/Safety regulations.

Disabling of high voltage electrical system



Via Service Interlock

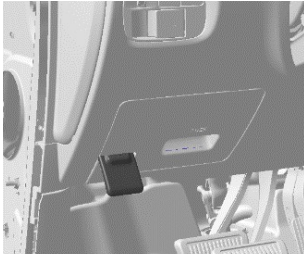

Pull the hood release lever to unlatch the hood.

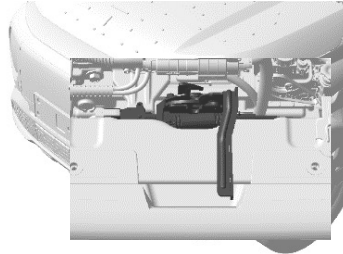

Go to the front of the vehicle, raise the hood slightly, push up the secondary hood release lever (1) inside of the hood centre and lift the hood (2).

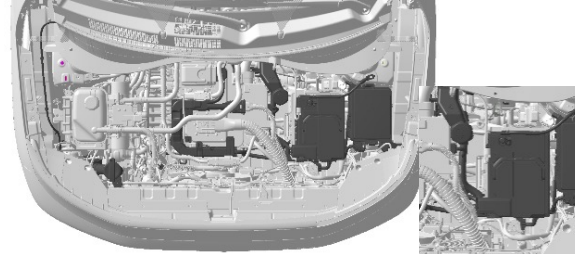

From the point of view the fuse box(4) is located on the right side.

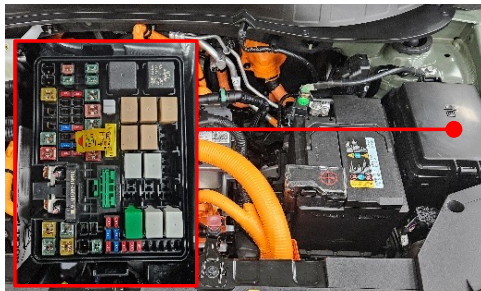

Open the cover of the box and find the "Service Interlock".

Pull up the "Service Interlock"

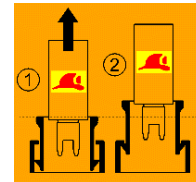

- HV connected
- HV disconnected

⚠ "Service Interlock" is not completely removable. ⚠

Disabling the 12V battery system Via Engine Start/Stop Button

It is possible to disable the 12V battery system from INSTER by using the "Engine Start/ Stop" button. The different modes with and without depressing the brake pedal are explained below.

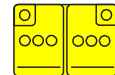

Via disconnect the terminals or connectors

To disable the 12V battery system it has to be sure that the vehicle engine is off. Is the "READY" light, on the instrument panel, illuminated, the vehicle is "ON". In this case turn "OFF" the system by press the "P" button on the shifter and press the "Engine Start/Stop" button. If it is necessary, lower the windows, unlock the doors and open the tailgate as required, before disconnecting the 12V battery. Once the 12V battery is disconnected, power controls will not operate. Before disconnecting the 12V battery, remove the smart key at least 2 meters away from the vehicle to prevent accidental restart. To disconnect the terminals or connectors the preferred procedure is as follows:



Electrocution Risk

- Before engaging in any emergency response procedures, ensure the vehicle is disabled and wait 5 minutes to allow the capacitor in the high voltage system to discharge to avoid electrocution.
- Exposed cables or wires may be visible inside or outside the vehicle. Never touch the metal chassis wires, cables, connectors, or any electric components before disabling the system.

3. Disable direct hazards/Safety regulations.

Via IG (Ignition) Fuse Removal

To disable the 12V battery system it has to be sure that the vehicle engine is off. Is the “READY” light, on the instrument panel, illuminated, the vehicle is “ON”. In this case turn “OFF” the system by press the “P” button on the shifter and press the “Engine Start/Stop” button.

If it is necessary, lower the windows, unlock the doors and open the tailgate as required, before disconnecting the 12V battery. Once the 12V battery is disconnected, power controls will not operate.

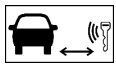

Before disconnecting the 12V battery, remove the smart key at least 2 meters away from the vehicle to prevent accidental restart.

To remove the IG Fuse follow procedure is prefer:

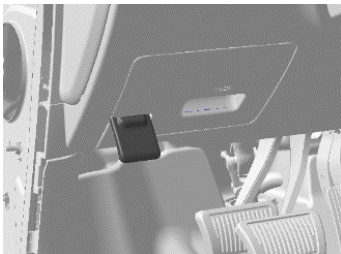

Pull the hood release lever to unlatch the hood.

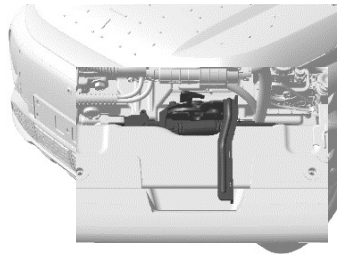

Go to the front of the vehicle, raise the hood slightly, push up the secondary hood release lever (1) inside of the hood centre and lift the hood (2).

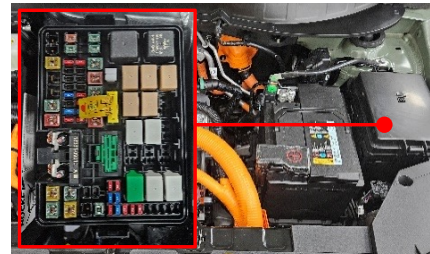

From the point of view the fuse box is located on the right side.

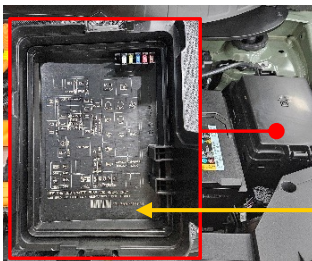

Remove the PE room fuse box cover. In the cover you can find the label describing fuse names and ratings.

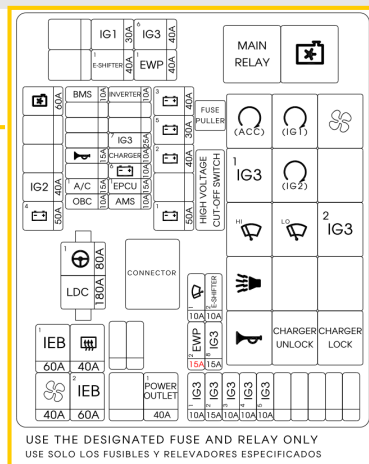

Refer to the label on the inside of the fuse cover to locate the fuse location of “IG1” and “IG2”.

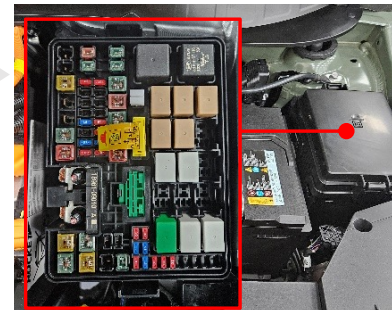

Pull both the “IG1” and “IG2” fuse straight out from the PE room fuse box.

Use the removal tool (1) provided in the fuses panel cover.



Safety Risk

If mentioned methods of disabling the vehicle’s system are unsuccessful, any emergency procedures involving the electric vehicle may cause the accidental deployment of undeployed airbags and electric shock from high-voltage components.

4. Access to the occupants.

Extraction Operations

The INSTER is an electric vehicle. Because of the high voltage components contained therein, first responders should pay special attention when they extract occupants in the car. Before performing any extraction operations, the first responders should “Identify, Immobilise and Disable” the vehicle as discussed in sections on emergency procedures. When the first responders cut the vehicle, they should always pay special attention to the airbag system, orange coloured high voltage cables and other high voltage components so that the parts are not damaged and to prevent a risk of explosion or electrocution.

Extraction Tools and Procedure

When responding to an incident involving the INSTER, we recommend that the first responders follow their organisation’s standard operating procedures for dealing with vehicle emergencies.

Location of Ultra-high Strength Steel

In these images, high strength steel is used in the areas coloured in blue and ultra-high strength steel is used in the purple-coloured areas. Depending on the tools used, ultra-high strength steel can be challenging or impossible to cut. If necessary, use a workaround technique.

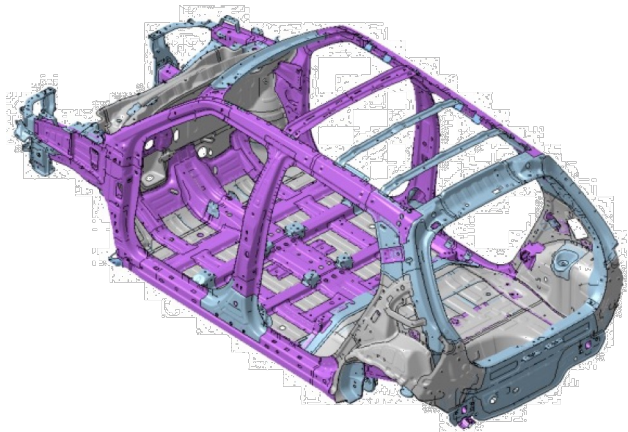
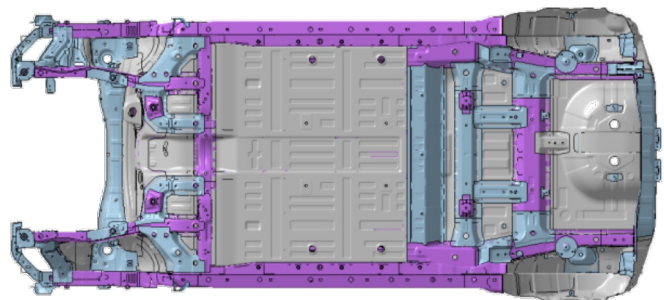
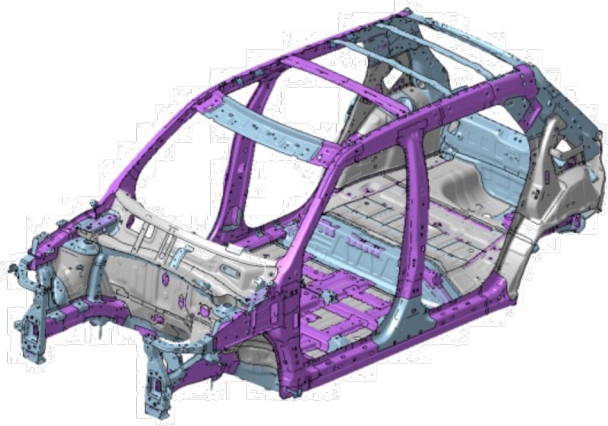

Colour	Steel type
Grey	Mild
Blue	High-strength
Purple	Ultra-high-strength



4. Access to the occupants.

Steering wheel adjustment

The INSTER is equipped with manual steering wheel adjustment. For better access to the occupant after accident, the steering wheel can be moved as follow.

Manual adjustment	
	
Pull down the lock-release lever (1).	
Adjust the steering wheel angle (2) and distance forward/back (3).	
Pull up the lock-release lever up to lock the steering wheel in place.	

Door and tailgate unlocking

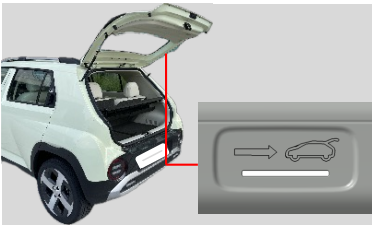
Mechanical unlock	Inside the vehicle	Central door lock
		
1. Pull the O/S HDL 2. Push the button 3. Remove key cover 4. Unlock with emergency key.	Front doors inner handles are pulled, the doors are unlocked and opened.	Pressing button (2) on the switch, all vehicle doors are unlocked.
Rotate [B] clockwise to unlock the vehicle and Rotate [A] counterclockwise to lock the vehicle.	Rear doors inner handles need to pulled once to unlocked. A second pull will open the doors.	
Tailgate		
Insert the key into the keyhole, and Rotate clockwise to lock and reverse to unlock.		
	Insert a long, flat object, such as a key, into the hole at the bottom of the tailgate trim. Slide the latch in the direction of the arrow to unlock the tailgate. Push the tailgate to open.	

4. Access to the occupants.

Windows and Glass



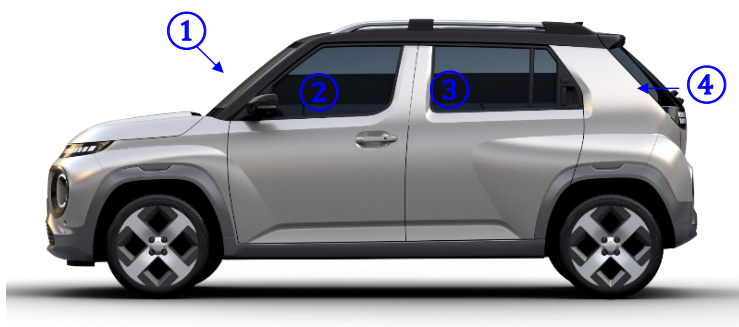

The INSTER is equipped with power windows. Each door has its own switch to control the door's window. The driver door has central power window lock button, which can block and unblock all operation of the rear passenger windows. The power windows operate for about 3 minutes after the Start/Stop button is in the ACC or OFF position. The INSTER can be fitted with an optional sunroof.



Glass type	
1	Laminated
2	Tempered
3	Tempered
4	Tempered

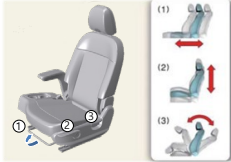
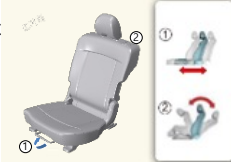

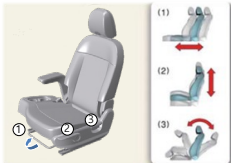

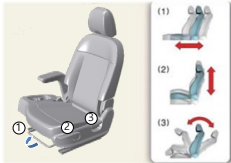
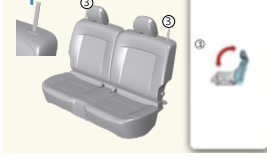



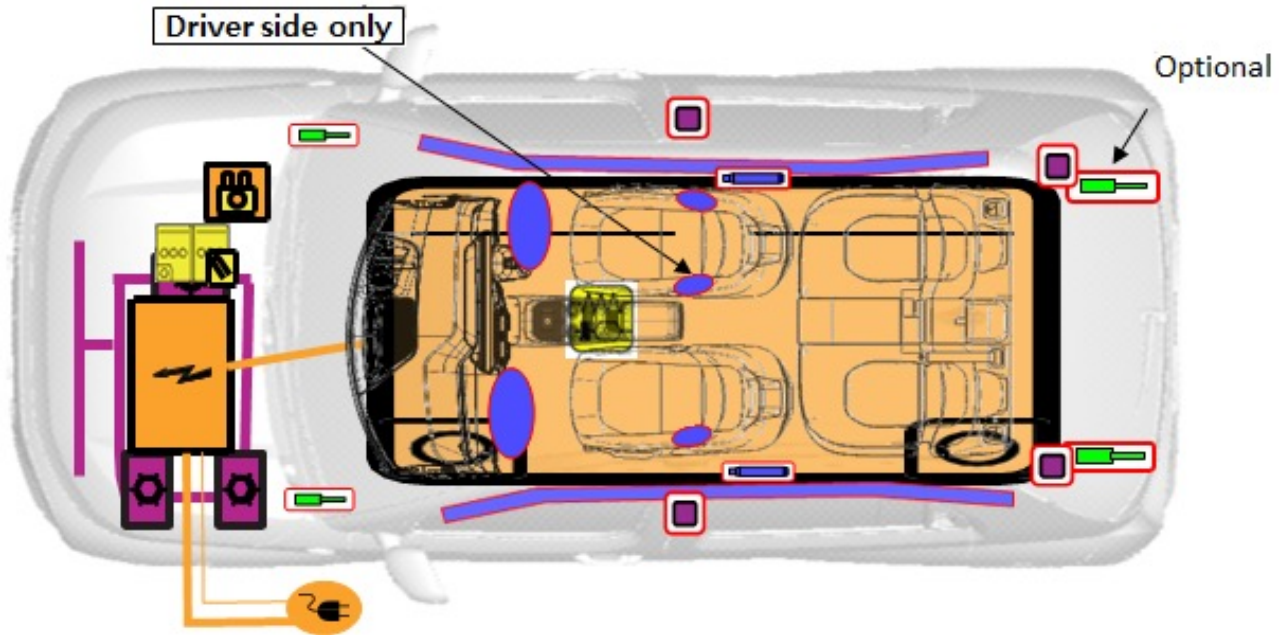

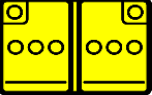







Seat adjustment

INSTER is equipped with manual seats in the 1st and 2nd row. Main functions are following:

Item	Manual		Rear Manual
Forward and rearward	<p>Pull up the ① slide adjustment lever and hold it. You can slide the seat forward And rearward. Release the lever to lock.</p> 	Rear Forward and rearward	<p>Pull up the ① slide adjustment lever and hold it. You can slide the seat forward And rearward. Release the lever to lock.</p> 
Seat cushion high 	<p>Push down the ② lever several times, to lower the seat cushion. Pull up the lever several times, to raise the seat cushion.</p> 	Rear Seat back angle	<p>Lift up the ② seatback lever. Carefully lean back on the seat and adjust the seatback. Release the lever to lock.</p> 
Seat back angle	<p>Lean forward slightly and lift up the ③ seatback lever. Carefully lean back on the seat and adjust the seatback. Release the lever to lock.</p> 	Rear Seat back angle (Bench Fix Type)	<p>Pull up the ③ seatback strap. Carefully lean back on the seat and adjust the seatback.</p> 

5. Stored energy/Liquid/Gases/Solids.



	12V	    									
	Long range 310.0 V Standard: 266.0 V	     									
	<table border="1"> <thead> <tr> <th></th> <th>w/o heat pump</th> <th>with heat pump</th> </tr> </thead> <tbody> <tr> <td>R-134a</td> <td>800g</td> <td>900g</td> </tr> <tr> <td>R-1234yf</td> <td>750g</td> <td>850g</td> </tr> </tbody> </table>		w/o heat pump	with heat pump	R-134a	800g	900g	R-1234yf	750g	850g	   
	w/o heat pump	with heat pump									
R-134a	800g	900g									
R-1234yf	750g	850g									

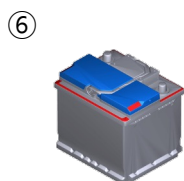
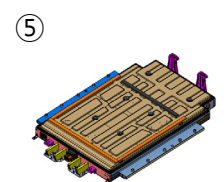
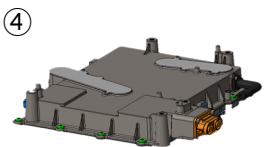
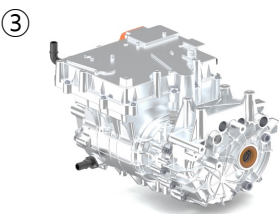
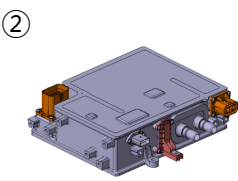
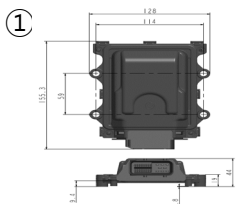

1. Vehicle Charging Management System (VCMS)
2. Integrated Charging Control Unit (ICCU)
3. Motor & Reduction Gear Assembly
4. Inverter
5. Battery System Assembly (BSA)
6. 12 V Auxiliary Battery

5. Stored energy/Liquid/Gases/Solids.

High-voltage system

High-voltage battery

The HV lithium-ion battery supplies and stores electric energy. It is located under the INSTER chassis.

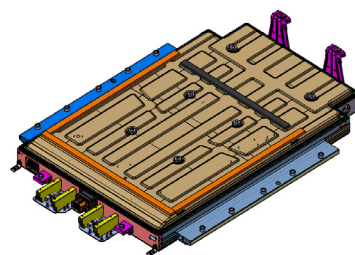

12V Auxiliary Battery

The 12V auxiliary battery powers all of the vehicle's standard electronics like a radio, lights, door locks, power windows, etc. Also, it powers the VCU (Vehicle Control Unit), VCMS (Vehicle Charging Management System) which controls the high voltage current and vehicle.

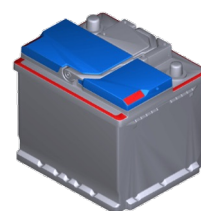

ICCU

The ICCU, located on top of the PE system in the PE room, below the PDU(J/B), incorporates an OBC and LDC.

- OBC: HV battery charging equipment that converts external AC to DC, to charge the high voltage battery.
- LDC: High voltage of battery is converted low voltage (DC 12V) through the LDC for supplying power to electrical components.

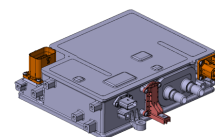

Motor		Type	Front : Interior Permanent Magnet Synchronous Motor (IPMSM)
		Max. Output (kW)	STANDARD : 71.1 / LONG RANGE : 84.5
		Max Torque (Nm)	147
ICCU	OBC	Max. Output (kW)	10.5
		Output Voltage(V)	DC 180~482
	LDC	Max. Output (kW)	1.96
		Input Voltage(V)	DC 144~482
High-voltage Battery		Type	Lithium-ion
		Rated Voltage (V)	Long-range : 310 / Standard : 266
		Energy (kWh)	Long-range : 49 / Standard : 42
		Quantity for Pack (Number of Modules)	Long-range : 21 / Standard : 18

5. Stored energy/Liquid/Gases/Solids.

High-voltage orange cabling

The high voltage cabling is orange, per Society of Automotive Engineers (SAE) standards. Cables run under the floor of the vehicle and connect the high voltage battery to the ICCU, Motor, Inverter, Junction box, A/C compressor and other high voltage components located towards the front of the vehicle.

You can identify the vehicle as an electric vehicle with the presence of orange cables under the hood, in the under-floor battery compartment, or HV cables under the car.

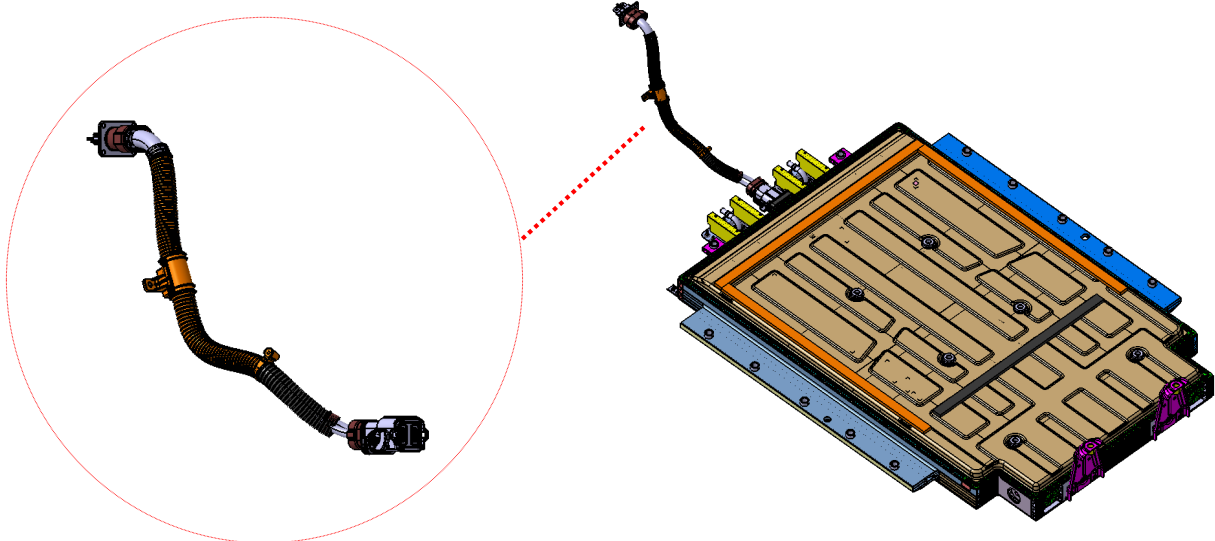

WARNING: High Voltage Cables



- Never cut or disconnect the high voltage orange cabling and connectors without disabling the HV system by removing the safety plug (refer to page 8 to 10).
- Exposed HV cables or wires may be visible inside or outside the vehicle. Never touch the metal chassis wires, cables, connectors, or any electric components before disabling the system.

Failure to follow these instructions will lead to serious bodily injury or death by electrical shock.

6. In case of fire.

Firefighting Operations

Strict precautions must be taken while conducting firefighting operations due to following reasons:

- Lithium-ion batteries contain gel electrolyte that can vent, ignite, and produce sparks when subjected to temperatures above 300°F (150°C).
- Vehicle may burn rapidly with a flare-burning effect.
- Even after the high/low voltage battery fire appears to have been extinguished, renewed or delayed fire can occur.
 - Use a thermal imaging camera to ensure the high/low voltage battery is completely cooled before leaving the incident.
 - Always advise second responders that there is a risk of the battery re-igniting.
 - In a fire, submersion or a collision that has compromised the high/low voltage battery, always store it in an open area with no exposures within 15 meters.
- A burning battery could release hydrogen fluoride, carbon monoxide, and carbon dioxide gasses. Use NIOSH/MSHA approved full-face self-contained breathing apparatus (SCBA) with full protective gear. Even if the high/low voltage battery pack is not directly involved in a vehicle fire, approach the vehicle very carefully.

Extinguishers

- Small fires that do not involve the high/low voltage battery should be extinguished using an ABC fire extinguisher. (ex. Fire caused by wiring harnesses, electrical components, etc.)
- Do not attempt to extinguish fires that involve the high/low voltage battery with small amounts of water as this can result in electrocution. Fires that involve the high/low voltage battery should be extinguished using large amounts of water (Max 10,000 litre) to cool the high/low voltage battery. Fire fighters should not hesitate to pour larger amounts of water on the vehicle in such scenarios. Make sure the battery is fully cooled to avoid fire re-ignition.

How to Deal with the Situation

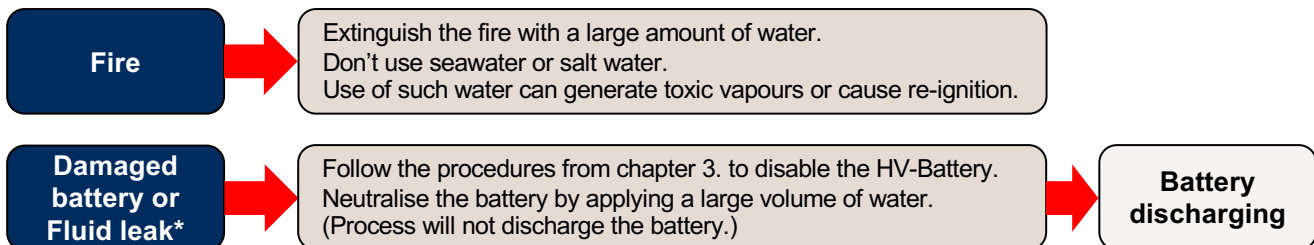

*To be used if electrolyte solution leakage or damage to the high/low voltage battery casing is observed.



Electrolyte Irritation

The high/low voltage battery contains electrolyte solution. To avoid exposure to electrolyte solution and serious personal injury, always wear appropriate solvent resistant PPE (Personal Protective Equipment) and SCBA (Self-Contained Breathing Apparatus).

- Electrolyte solution is an eye irritant. In the event of contact with eyes, rinse with plenty of water for 15 minutes.
- Electrolyte solution is a skin irritant. Therefore, in the event of contact with skin, wash off with soap.
- Electrolyte liquid or fumes coming into contact with water will create vapours in the air from oxidation. These vapours may irritate skin and eyes. In the event of contact with vapours, rinse with plenty of water and consult a doctor immediately.
- Electrolyte fumes (when inhaled) can cause respiratory irritation and acute intoxication. Inhale fresh air and wash mouth with water. Consult a doctor immediately.

6. In case of fire.

Vehicle Fire

- Use a large volume of water (max. 100,000 litre). Water must cool down the battery.
- If water is applied directly onto the high/low voltage battery module inside the casing, it will better cool the battery. (But, never attempt to penetrate the HV battery or its casing to apply water.)
- Putting water into the high/low voltage battery can be difficult due to the battery case.
- Put water through the hole that might be made due to the accident or fire.

High/Low Voltage Battery Damage and Fluid Leaks

If electrolyte solution leakage or any damage to the Lithium-ion battery casing is observed, the first responders should attempt to neutralise the battery by applying a large volume of water to the battery pack while wearing appropriate Personal Protective Equipment (PPE). The neutralisation process helps stabilise the thermal condition of the battery pack but does not discharge the battery.

- Do not put any smoke, spark, flame around the vehicle.
- Do not touch or step on the spilled electrolyte.
- If electrolyte leak occurs, wear appropriate solvent resistant PPE and use soil, sand, or a dry cloth to clean up the spilled electrolyte.

Be sure to adequately ventilate the area.

High/Low Voltage Battery Re-ignition by Stranded Energy

Damaged cells in the high/low voltage battery can experience thermal runaway* and re-ignition.



Use Infrared Camera (IR-Cam) to observe thermal runaway. Focus the battery with the IR-Cam the whole time. Increase of the temperature could indicate a thermal runaway.

To prevent re-ignition, the first responder and second responder need to be aware of the risk of stranded energy* which remains in the damaged cells and can lead to re-ignition. Therefore, disconnect the 12V battery (-) terminal to depower the battery management system (BMS). After that shut off the HV-System explained in chapter 3 and discharge the HV-Battery refer in chapter 8.

*Thermal Runaway

The originating cause of thermal runaway is generally short-circuiting inside a battery cell and a resulting increase in the cell's internal temperature.

Battery produces heat with thermal runaway and it can spread from one battery cell to many cells, in a domino effect.

*Stranded energy

Energy remains inside any undamaged battery cells after the accident. Stranded energy can cause a high/low voltage battery to reignite multiple times after a fire has been extinguished.

7. In case of submersion.

Submerged or partially submerged vehicles

Some emergency responses can involve a submerged vehicle. The INSTER does not have high voltage components on the vehicle's body or framework. It is safe to touch the vehicle's body or framework if there is no severe damage to the vehicle, whether it is in water or on land.

In the event that the vehicle is submerged or partially submerged, remove the vehicle from the water before attempting to disable the vehicle. Drain the water from the vehicle. Use the methods described in chapter 3. to disable the vehicle. Then, discharge the battery by referring to chapter 8.



Safety Risk

- If severe damage causes high/low voltage components to become exposed, responders should take appropriate precautions and wear appropriate insulated personal protective equipment.
- Do not attempt to remove a high voltage cable while the vehicle is in water.

8. Towing/Transportation/Storage.

Towing service

If towing the INSTER vehicle is necessary, it is recommended to have it done by an authorised Hyundai dealer or a commercial tow-truck service. To prevent damage to the vehicle, proper lifting and towing procedures are necessary. The vehicles must be towed with a wheel lift and dollies or flatbed with all the wheels off the ground. The use of wheel dollies or flatbed is recommended. If any of the loaded wheels or suspension components are damaged or the vehicle is towed with the front wheels on the ground, use a towing dolly under the front wheels.

When the vehicle is being towed, take care that the engine is OFF or in ACC position, to prevent accidental deployment of undeployed airbags.

In the event of an accident, the high voltage system must be disabled. (refer to chapter 3.)



DO NOT

- **DO NOT** lift using the trailer hitch or body and chassis parts.
- **DO NOT** tow with sling-type equipment. Use wheel lift or flatbed equipment. **(1)**
- **DO NOT** tow the vehicle with the front wheels on the ground (forward or backward), as this may cause fire or damage to the motor. **(2)**

8. Towing/Transportation/Storage.

Storage of damaged vehicle with the damaged battery

- Drain fluids and water, then disconnect the negative (-) terminal of the 12 V battery before storing a damaged vehicle.
- In addition, remove the water inside the battery or vehicle, then remove the service plug from the high voltage battery before storing a damaged vehicle.
- Place the vehicle in an open space away from any structure, vehicle, or building.
- Then, keep on eye on the vehicle until the discharging procedures are completed.
- If the battery can be removed from the vehicle by moving the vehicle on the lift, remove and discharge the battery.
- If the battery can't be removed, set the water pool and pouring water until the entire battery is submerged.

Battery discharging in water pool



Water pool condition

- Tap water or pond water that does not contain salt.
- Maintain this water level for at least 90 hours.
- Then, put salt into the water pool to make 3.5 % salt water.
- Wait for additional 48 hours in salt water.



Battery discharging

- DO NOT USE SALT WATER for the first step.
- A large volume of flammable hydrogen gas can be generated in salt water due to electrolysis.
- After submerging the vehicle in pure water for at least 90 hours, put salt in the water pool.

Damaged Battery Storage

- To store the damaged battery safely, the battery must be discharged.
- If the battery can be removed from the vehicle, discharge the battery to prevent re-ignition.
- Prepare water that does not contain salt such as tap water or pond water.
- Leave the battery in water for at least 90 hours.
- Then, put salt in water to make 3.5% salt water.
- Wait for additional 48 hours in salt water.
- Take out the battery from the container and dry it.

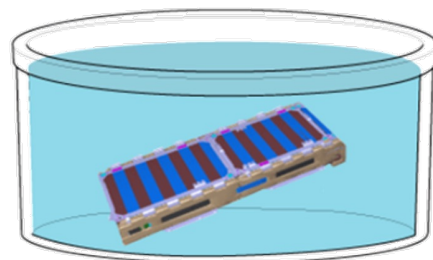





Safety Risk

- Extinguish all smoke, spark, flame around the vehicle.
- Electrolyte solution is a skin irritant.
- Do not touch or step on the spilled electrolyte.
- If electrolyte leak occurs, wear appropriate solvent resistant PPE and use soil, sand, or a dry cloth to clean up the spilled electrolyte. Be sure to adequately ventilate the area.

9. Important additional information.

The INSTER comes standard with airbags, seatbelt pre-tensioners and gas struts, see picture below. Some of the features are explained in this chapter.

Safety Equipment	
	Airbags
	Gas Inflator
	Pre-tensioner
	Gas strut
	SRS control unit

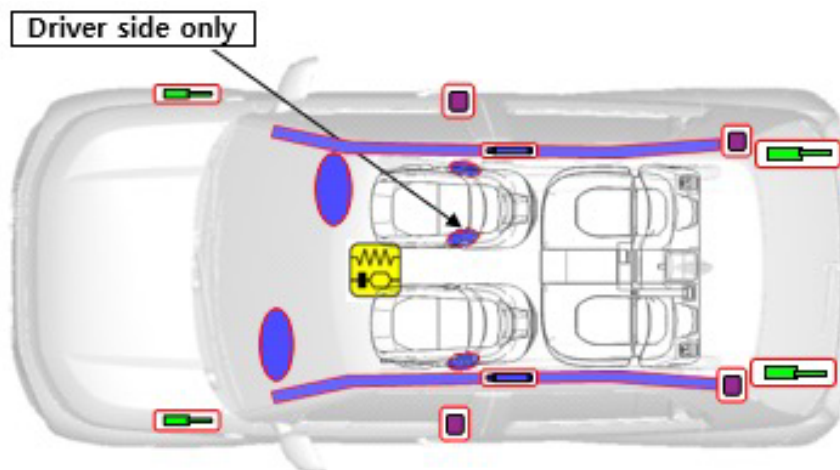

Emergency Starting

Jump Starting

Do not attempt to jump start the high voltage battery, as it cannot be jump started. In case of full discharge of the high voltage battery, the vehicle must be towed as mentioned on the previous page.

In case the 12V auxiliary battery is discharged, connect a starting device to the jump terminal in the engine room as you would any 12V battery (see image). Refer to the "Emergency Starting" section of the Owner's Manual for additional information. Connect jumper cables in the order shown in the image and disconnect in reverse order.

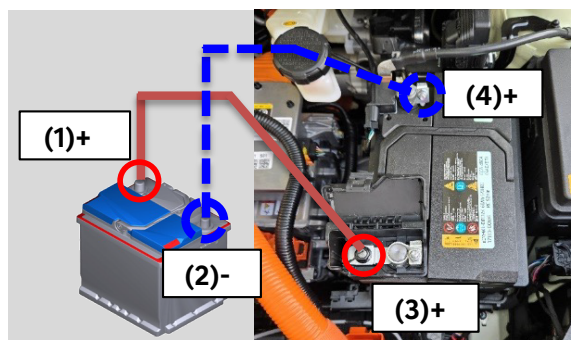

Jump Starting Procedure

1. Connect the jumper cables as shown.
 - Positive (+) terminal of the flat battery **(1)** and the booster battery **(3)**.
 - Negative (-) terminal of the flat battery **(2)** and the grounding point **(4)**.
2. Start the vehicle with the booster battery for several minutes.
3. Try to start the vehicle with the flat battery again.
4. If the vehicle starts, disconnect the jumper cables as following:
 - Negative (-) terminal of the booster battery **(4)**.
 - Positive (+) terminal of the booster battery **(3)**.
 - Flat battery **(1,2)**.

If the vehicle still does not start, contact a professional workshop or seek other qualified assistance. Hyundai recommends to call an authorised Hyundai dealership.



Risk

- Do not attempt to jump start the INSTER high voltage battery.
- Failure to follow these instructions will lead to serious bodily injury or death by electrical shock.

9. Important additional information.

Airbag system (SRS: Supplemental Restraint System)

Airbag

7 airbags are installed in the INSTER, located in the areas shown in the image below. Before performing any emergency procedure, make sure the vehicle ignition switch is turned off and disconnect the negative connector from the 12V auxiliary battery (located in the left side motor compartment) to prevent accidental deployment of undeployed airbags.

Type	
1	Passenger's front air bag
2	Front centre side air bag only driver seat
3	Driver's front air bag
4	Side air bag (left/ right) : Only Front Side
5	Curtain air bag (left/ right)

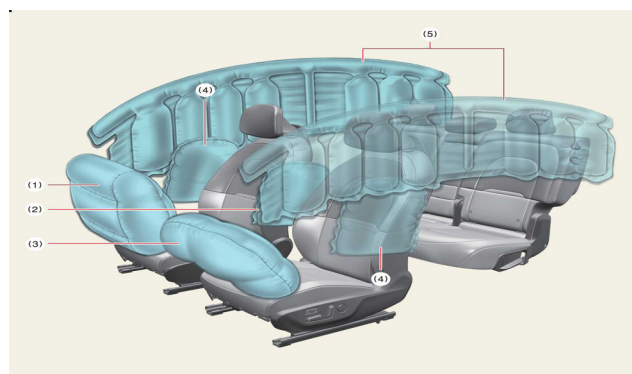

* The actual air bags and seats in the vehicle may differ from the illustration.

Seat Belt Pre-tensioner

In the INSTER, the driver's, front passenger's and rear seat belts are equipped with pretensioners. When the seat belt pretensioners are activated in a collision, a loud noise may be heard and fine dust, which may appear to be smoke, may be visible in the passenger compartment. These are normal operating conditions and are not hazardous. The seat belt pretensioner assembly mechanisms may become hot during activation, and may need several minutes to cool down after they have been activated.

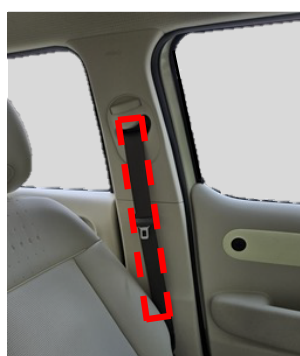
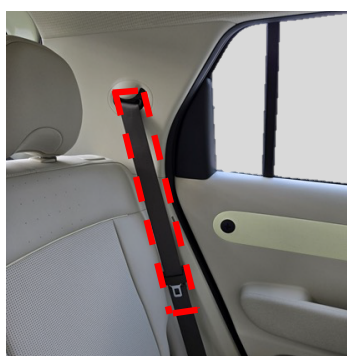

























Undeployed Airbags

- Do not cut the red coloured part shown in the image above.
- Make sure the vehicle ignition switch is turned off, disconnect the negative cable from the 12V auxiliary battery (located in the left side of motor room) and wait 3 minutes or longer to allow the system to deactivate.

10. Explanation of pictograms used.

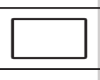
Table of used pictograms in this document.

	Electric Vehicle		Low voltage device that disconnects high voltage		Bonnet
	General warning sign		Air-conditioning component		Boot
	Corrosives		Hazardous to the human health		Flammable
	Explosive		Acute toxicity		Environmental hazard
	Use thermal Infrared camera		Use water to extinguish the fire		Warning, Electricity
	Steering wheel, tilt control		Seat adjustment, longitudinal		Seat height adjustment
	Battery pack, high-voltage		Battery low voltage		Emergency door opener
	High voltage component		SRS control unit		Zone requiring special attention
	Remove smart key				

Hyundai Premium Roadside Support.

1800 186 306